



Smart Phone &
Tablet Friendly
(See Inside Cover)



VIBRATIONS *Good* **VIBRATIONS**®

Whittier, California **MOTORSPORTS**

*Specializing in Fuel Injection
& Supercharged Applications*

*Empowering
Racers
Since 1989*

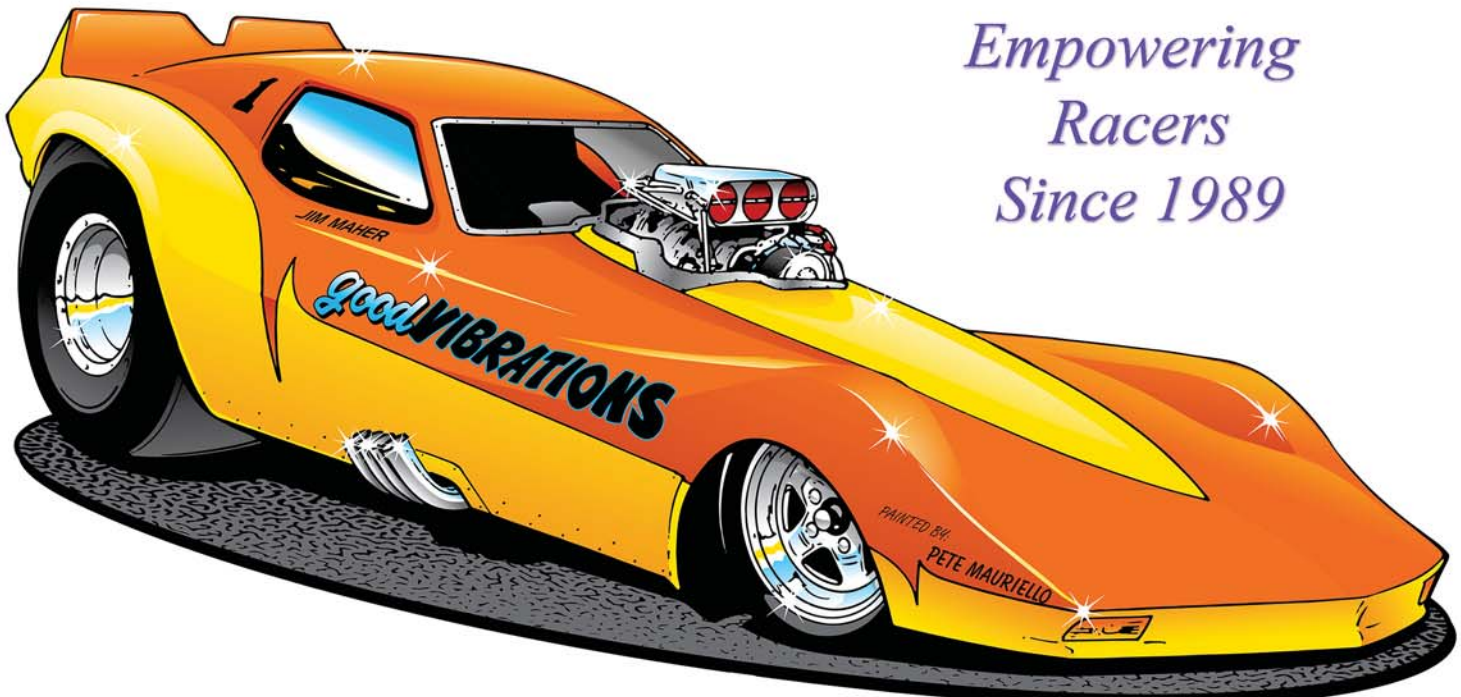

DragParts.com 800.576.7661

At Good Vibrations Motorsports we strive to provide high quality performance products at discount prices without sacrificing customer service.

This catalog is Smart Phone & Tablet Friendly !!



Why Scan the QR Codes?

- * Order Online
- * Current Prices
- * Specifications
- * Options (Color, Sizes, etc..)
- * Technical Tips
- * How-To-Videos
- * Discounts & Promotions!
- * Download Catalog
- * **And Much, Much More....**

We ship Domestic & International Daily.

Our freight costs are very reasonable and competitive.



Good Vibration Motorsports is the Official



"Drag Racing Specialty Parts"

of Auto Club Famoso Raceway



How to Contact Us



Orders... **800/576-7661** E-mail.... **sales@DragParts.com**

Tech/BS **562/945-7669** Web..... **GoodVibrationsRacing.com**

Ship & Snail Mail: **8858 Painter Ave, Ste. E, Whittier, CA 90602 USA**

Why Buy From Good Vibrations?

* Prices

Never pay Retail. All products are generously discounted.

* Quality

We sell premium quality products only.

* Technical Support

No Question is too tough.

Deal directly with enthusiasts that speak your language.

* Promptness

98% of orders are shipped the same day :-)))

GUARANTEED Ground Shipping Time
Or your money back!



Outbound View

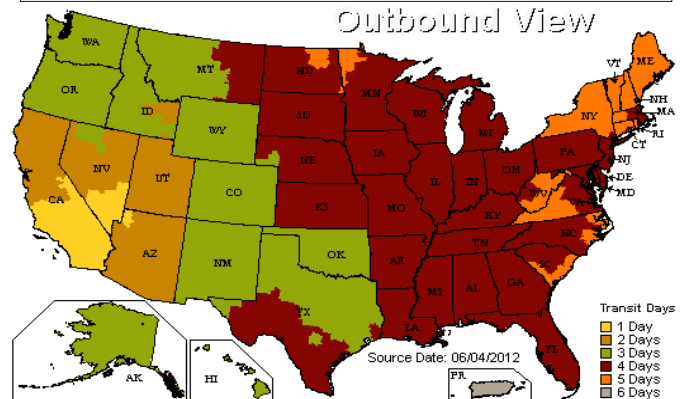

We also Ship International Daily!



59th Annual
Mar 2-5, 2017

Good Vibrations is a Major Sponsor of these IHRA IHRA Nationals!



Event Dates & Info



Class Sponsor!

Telephone Orders

Open between 6am - 5pm (PST) Mon-Fri. Also online at: GoodVibrationsRacing.com. Most orders are processed and shipped within 24 hours. UPS, DHL & USPS are the methods of shipping unless otherwise specified. Domestic UPS Ground is approximately 1-4 business days, depending on your location. Faster service is available (See chart on left page).

Payment Policy & Returns

Orders can be Paid by Amer Express, Mastercard, Visa, Discover credit/debit cards or Paypal. No reasonable return will be refused though cancelled orders and returns can be subject up to a 20% restock fee. A copy of the original should accompany all returns within 30 days of the original purchase date.

A RMA number is required for returns.

Freight & Shipping

All shipments are shipped freight prepaid unless other arrangements are made. All shipments are fully insured. If your shipment is damaged, save all packaging material and contact the freight carrier immediately.

Prices & Specifications

California Sales are subject to state sales taxes.

All prices are subject to change without notice.

Shortages or Discrepancies

All shortages or discrepancies must be reported within 10 days from receipt of shipment. Please include invoice number and date of receipt.

Warranty

THIS MERCHANDISE IS INTENDED FOR OFF-HIGHWAY USE, MAINLY RACING. THE EFFECTIVENESS WARRANTY AND LONGEVITY OF THIS EQUIPMENT ARE RELATED DIRECTLY TO THE MANNER IN WHICH IT IS INSTALLED, USED AND /OR MAINTAINED. WE CANNOT BE RESPONSIBLE FOR THE QUALITY OF INSTALLATION, AND WE ARE NOT RESPONSIBLE FOR DAMAGE OR INJURY, DIRECT OR CONSEQUENTIAL, LOSS OR CASUALTY WHICH MIGHT RESULT FROM CIRCUMSTANCES BEYOND OUR CONTROL.

Some products carry the manufacturers warranty.

Not for sale or use on pollution controlled vehicles

Fuel Injection	4-13
Linkage-Cables	14-15
Supercharging	16-25
Bearings-Rings	26-27
Valve Covers-Pit Mat	28-29
Steering - Brakes	30
Tabs - Rod Ends	31
Starters	32
Safety Product	33-37
Specialty Tools	38-41
Hose & Fittings	42-47
Gaskets	48-51
Gear Drives	52-53
Oils & Lubes	54-55
Magnetos	56-57
JAZ Products	58-59
Oil Systems	60-62
Neat Stuff	63



phil. 4: 6-7





FREE Catalog!

800/576-7661

Phantom Universal



Phantom Universal Fuel Pump System allows the option to install a High-Performance pump inside virtually any fuel tank from 6" deep to 11" deep, including your factory tank and can support both Forced Induction and Naturally Aspirated motors.

AER-18309 Dual Phantom Sys **\$687** **AER-18688** Single Phantom Sys **\$489**

340 Stealth Series



Designed for In-Tank use.

\$168

340 Stealth Series are High-Output Electric Pumps that will fit most popular EFI & CARB applications. Pump will bolt onto many existing Hanger assemblies. **2 styles:** Center or Offset Inlet.

AER-11540 Center Inlet **AER-11142** Offset Inlet

A1000 Series



A1000 Fuel Pump Series is ideal for high horsepower EFI or Carb applications. Features a Female AN10 ORB inlet and a AN10 ORB outlet port.

Pump is fully submersible for custom In-Tank placement.

AER-11101 In-Line. 1000HP EFI / 1300HP Carbs **\$398**

Erica Enders-Stevens Back To Back Pro Stock Championships with Aeromotive A-3000 Fuel System !!



A3000 Series

Ideal for high horsepower Carb applications. Features a Female AN12 ORB inlet and a AN10 ORB outlet port. Ideal for Bracket Cars, Pro Mods, etc..

6.8gpm @ 5psi (over 400gph)

Regulator & Filter can be clocked in 45 degree increments.

AER-11215 Complete Kit **\$598**

AER-11216 A3000 Pump **\$329**

AER-11217 Adj Regulator **\$138**

AER-11218 100 Micron Filter **\$179**

Gas or Alcohol

Adjustable Regulators

Aeromotive Regulators are some of the finest on the market. Machined from Billet Aluminum. Includes mounting bracket.

Available for EFI & Carb Applications



a



b



c

a. **AER-13109** EFI. Two AN6 Inlets w/ One AN6 Return **\$181**

b. **AER-13204** Carbs. By-Pass. 2-Port **\$189**

c. **AER-13301** Carbs. By-Pass. 3-Port 3/8 npt **\$151**



Aeromotive
Products



800/576-7661

Billet Fuel Pumps

Fuel pumps are flowed and compatible with all fuels.

Billet **G-Rotor** Gear pumps are CNC machined to perfection and hard anodized for durability. Cam driven (CW) or belt driven off the crank (CCW). Utilizes a 3/8 hex drive shaft and can be rotated after mounting.

AER-11107
6.8gpm **\$714**

Female AN10
In & Out

Compatible to
Enderle's 80A-1

\$29

Inlet & Outlet Fittings
Includes: SS bolts & O-rings

- AER-11745** Female AN8
- AER-11746** Female AN12
- AER-11747** Male AN16
- AER-11748** Male 1.25 Barb

AER-11117
11.4gpm **\$898**

ATOMIC

Compatible to
Enderle's 110

Billet Y-Blocks

Anodized Black
Corrosion Resistance
Compatible with all fuels

AER-15673 AN8-6	\$ 43
AER-15674 AN8-8	\$ 55
AER-15675 AN10-8	\$ 47
AER-15677 AN12-8	\$ 56

Spur Gear Fuel Pumps



Legal!



Billet **Gear** pumps are CNC machined to perfection and are type III hard coat anodized for durability. These pumps can be cam driven (CW rotation) or belt driven off the crank (CCW rotation). Utilizes a 3/8in

Got Nitro?



hex drive shaft. Outlet and inlet fittings are interchangeable. Pumps have the ability to be mounted with the standard 4-bolt pattern or with a quick-release flange (sold separately).

COMPLETE: Pump, Inlet & Outlet Fittings, 3-way Shut-Off Valve and Q.R. Clamp.

- | | | |
|--------------------|-------------------------|---------------|
| AER-11134 | 16gpm (Alky or Nitro) | \$1526 |
| AER-11935 | 21.0gpm. IHRA Nost FC | \$1587 |
| AER-11935.C | 21.0gpm. FC Complete | \$1928 |
| AER-11940 | 20.9gpm. NHRA Nost FC | \$1869 |
| AER-11940.C | 20.9gpm. FC Complete | \$1998 |
| AER-11941 | 20.0gpm. NHRA Drgstr | \$1869 |
| AER-11941.C | 20.0gpm. Dgstr Complete | \$1998 |

Spur Gear Pump Components



- | | | | |
|------------------|------------------|-----------------------------|---------------|
| In Stock! | AER-11730 | 1.250 Male Inlet Fitting | \$ 48 |
| | AER-11731 | 1.500 Male Inlet Fitting | \$ 48 |
| | AER-11733 | AN10 Female Fitting | \$ 48 |
| | AER-11734 | AN12 Female Fitting | \$ 48 |
| | AER-11735 | Quick-Release Flange | \$ 58 |
| | AER-11736 | 3 & 4 Bolt Flange | \$ 58 |
| | AER-11741 | Shut-Off Valve <i>Alky</i> | \$ 210 |
| | AER-11743 | Shut-Off Valve <i>Nitro</i> | \$ 210 |
- Ships Same Day!**



Clarence & Jeremy: *Depends on 5 Aeromotive Pumps!*



*Good Vibrations
Motorsports is the Largest
Dealer in the World of
Enderle Fuel Injection
products!!*



Blown Injection



*Blower Injectors are complete with:
Polished hat, Barrel Valve, Fuel Lines
(Rubber or SS), Nozzles & Bodies,
Check Valve, Distribution Block &
Bypass Pills, Instructions.*

- E-1001 Bugcatcher Gas \$ 1339**
- E-1002 Bugcatcher Alky \$ 1274**
- E-1003 Birdcatcher Gas \$ 1536**
- E-1004 Birdcatcher Alky \$ 1469**

Injector Assemblies are set up FREE per customer application !

3-Rib Nostalgia Bugcatcher *It's Back!*

This cool injector is nearly identical to the original Bugcatcher of days gone by. Has the three ribs on the top rear. Ideal for that nostalgia look.



- E-4005F Partial Hat \$ 676**
- E-1002F Complete Assy \$1319**

Injector Hat - Partial

Includes:
Polished Hat,
Shaft, Stops,
Double Arms
and Butterflies.



- E-4005 Bug \$ 629**
- E-4006 Bird \$ 832**

Injector Hat Filter Assembly

**Sand Drags * Mud Bogs
Tractor Pullers**

*Keeps rocks and
debris out of your
engine & blower*



Sizes: 5, 7 & 10"



Kit includes:

- Outerware
- **Billet** Aluminum Housing
- SS Quick Disconnect Pins
- Mounting Hardware
- Reusable Filter element



- Bugcatcher **\$ 375**
- Birdcatcher **\$ 349**
- Filter Only **\$ 79**
- Cleaner -Oil **\$ 13**
- SS QR Pin **\$ 19**
- Big & Ugly **\$ 395**
- Filter Only **\$ 93**

Outerware Colors:
(Red, Orange, Blue, Black, Purple) **from \$ 21**





Professional
Products
at Sportsman
Prices!



Injector Hats

Fuel Injection⁷

800/576-7661



**Big & Ugly
(BAU)
Injectors**



COMPLETE: Hat, Barrel Valve, Fuel Lines, Nozzles & Bodies, Check Valve, Dist Block & Bypass Pills.
Partial Includes: Polished Hat, Shaft, Butterflies, Stops & Arms.

Polished Aluminum

Complete Assembly

- E-BAU-3-36 3 9/16" .. **\$2071** or 4 3/8" ... **\$ 2056**
- E-BAU-1-5 5" **\$2342** or 9/16" ... **\$ 2327**

Partial Assembly

- E-BAU-3SB-36 3 9/16" **\$1289** or 4 3/8" **\$ 1274**
- E-BAU-1-SB-5 5" **\$1560** or 5 9/16" **\$ 1545**

4 Butterfly Sizes:

3 9/16, 4 3/8, 5 & 5 9/16"

Weight 16lbs, 2 Heights: 8.3" Tall or 10.5"

Carbon w/ Billet Alum Front

8" Tall & 5 9/16 Butterflies.

- E-BAU-4 Complete .. **\$ 4154** Partial .. **\$ 3372**

3-Hole Upright Injectors



Ideal for:
Tractor Pullers
Mud Buggers
Magnesium !

Fits Blower or Tunnel Ram

- E-1013A with Filters ... **\$1677**
- E-1014A w/o Filters **\$1464**

Aluminum Injector Hat is Enderle's replica of the original carbon fiber hats. It has a highly luster polished finish and billet front.



**Progressive
Linkages**

Need Partial Throttle?

Allows better partial throttle by opening just one butterfly first. The other butterflies are then opened progressively.



- E-BAUPLA Installed on new hat **\$ 241**
- E-BAUPL1 Retrofit existing hat **\$ 359**



Need some FREE Tuning Advice?

Call upon the Good Vibrations team. They have won an unprecedented 5 CIFCA Championships. And they are eager to share their knowledge and experience with you.

Why Enderle Fuel Injection ?

- * *Consistent & Responsive*
- * *Dependable & Affordable*
- * *FREE Tech Support*
- * *Looks Cool!*



Intake sold separately



Online Prices
& Styles

Injectors are set up per customer application **FREE** at **NO** additional charge.

Tunnel Ram Injectors are Complete with:

Polished Hat, Barrel Valve, Fuel Lines, Nozzles & Bodies, Main and Secondary Check Valves, Dist Block & Bypass Pills.

- E-2100A Bugcatcher Assy
- E-2101A Birdcatcher Assy
- E-BAU-3A-36 Big & Ugly
- E-7070 Edelbrock SBC TR Base
- E-7075 Edelbrock BBC TR Base
- E-6209 Dart BBC Tall Deck w/ Adap
- E-460BT Blue Thunder BBF Base
- E-TRA7075 BBC Top Adap Plate
- E-TRA6209 BBC Dart Top Adap Plate
- E-SBTRA SBC Top Adap Plate
- E-6233 BBC Dart Top Adap Plate

Convert Your 4 Barrel Manifold into Fuel Injection!

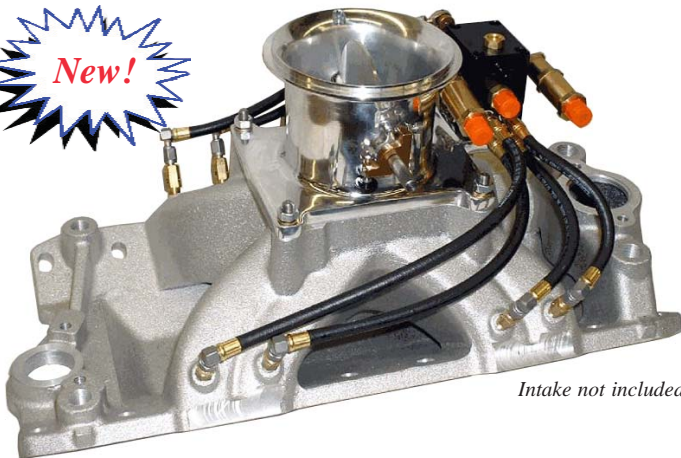

Intake not included

Very Consistent & Responsive

Injectors complete with: Barrel Valve, Lines, Nozzles, Pills and Air Filter Bracket. Has standard Holley four barrel bolt pattern. **Gas, E85 or Alky.**

FREE Setup and Calibration per your Application!

Single Body - Assembly

E-2020.39 4" **\$1169**

E-2020.50 5" **\$1189**

Dual Body - Assembly

E-2030.39 4" **\$1639**

E-2030.50 5" **\$1699**

Single Body - Partial

E-4080.39 4" **\$ 420**

E-4080.50 5" **\$ 462**

Air Filter Assembly

E-2020.39F 4" **\$ 212**

E-2020.50F 5" **\$ 232**

Progressive Linkage

E-67-260FSB **\$ 59**

Single/Dual Butterfly Injector



K&N
Filter



E-67-260FSB



Stainless Steel Pump Loop Lines

Pre-bent stainless steel loop lines are designed to return fuel to inlet of pump.

most **\$21**
Line Only

E-110SOT6 110 Shutoff using a tee (shown)

E-110HS6 110 High Speed

E-110SO6 110 Shutoff

E-80AHS6 80A High Speed

E-80ASO6 80A Shutoff

E-80ASOT6 80A Shutoff using a tee

E-LOOP-AN6 AN6 K-style B/V (shown)

Pump Inlet
Fitting with
Returns.
from **\$43**

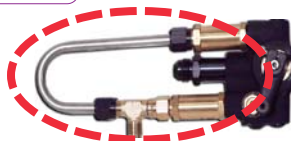

Complete Loop Kits: **\$75 to \$89**



Billet Fuel Logs

Mounts to the
side of
Shutoff Valve.



FI-2100 \$99

\$89

FI-2106

Routes three AN6 returns.
Side or bottom outlet.

Routes four AN6 returns into one outlet.
Accepts "Screw-In" style bypass pills.

Pump Belt Drive

Belt Drive Kits allow one to drive the fuel pump off the crankshaft. Required if your water pump blocks access to the cam.

from **\$294**

- E-5011** SBC
- E-5010** BBC
- E-5012** SBF
- E-5014** BB Mopar
- E-5014A** Blown
- E-5015** BBF



Flowed Fuel Pumps

Pumps are **Coated** inside.
Cam or Belt Driven



- E-3002** 80A-0 (4.5 gpm) **\$ 547**
- E-3003** 80A-1 (7.1 gpm) **\$ 547**
- E-3003.DSR** 80A-1 (7.5) **\$ 589**
- E-3004A** 600 (9.2 gpm) **\$ 595**
- E-3004** 110 (13.2 gpm) **\$ 595**
- E-3005** 990 (15.7 gpm) **\$ 696**
- E-3006** 1100 (17.2 gpm) **\$ 738**
- E-3008** 1270 (20.2 gpm) **\$ 809**

Pump Components

- E-2000C** 3-Hole Collar **\$ 41**
- E-3000C** 4-Hole Collar **\$ 59**
- E-88011** 11mm Bearing **\$ 14**
- E-6002 ZZ** 15mm Brng **\$ 13**
- E-114HC-11** .433 Seal **\$ 24**
- E-114HC-15** .590 Seal **\$ 24**
- E-PS-15** .590 Seal -New **\$ 10**

Fuel Pump Exts

3pc Billet Aluminum
360 Degrees Adjustable
Internal Shaft & Bearing



Lengths:
2 - 6 inches
1/2" increment

- Standard Ext from **\$ 132**
- Quick Release from **\$ 162**
- FI-2315** SS Clamp **\$ 43**
- FI-5213** Billet Clamp **\$ 139**

3-Way Fuel Shutoff Valve

Adjustable 360 Degrees and
includes Arm & Fittings.

Mandatory on Enderle pumps

Shutoff Valve

- E-85110** AN6 **\$ 95**
- E-85210** AN8 **\$ 127**
- E-85310.12** AN12 ... **\$ 172**

O-Ring/ Seal Kit

- E-85103** AN6 **\$13.99**
- E-85203** AN8

Also in stock for Nitro.

S/O Bracket Kit

- E-80ABR** 80A Pumps **\$35.99**
- E-110BR** 110 Series

Over-Center Spring Bracket Assy

This bracket setup will hold the Enderle shutoff valve positively in the **ON** position until it is turned off manually.

Includes: Billet Alum Bracket,
SS Spring, Bolt & Nut.

- FI-5140** AN6 S/O **\$39.99**
- FI-5142** AN8 S/O
- FI-5144** AN12 S/O





FREE Catalog!

800/576-7661

Premium Fuel Injection Components



- E-4013 * 4014 * 4103CF
- E-4013** Bugcatcher Butterfly \$ 15.99
- E-4014** Birdcatcher Butterfly \$ 19.99
- E-4103** Buzzard Butterfly \$ 22.99
- E-4103CF** Big/ Ugly Butterfly \$ 26.99
- E-4011** Small Serrated Arm BILLET \$ 10.99
- E-4011A-5/16** Double Serrated Arm Bug \$ 18.99
- E-4011A** Double Serrated Arm 7/16 Bird/Buzz/BAU .. \$ 18.99
- E-4011A.44B** Double Serrated Arm 7/16 BILLET \$ 38.99
- E-4011B** Long Double Serrated Arm Bird/Buzz \$ 20.99
- E-4012.31** Throttle Stop Bug 5/16 \$ 11.99
- E-4012.44B** Throttle Stop 7/16 Bird/Buzz/BAU BILLET .. \$ 23.99
- E-4012TS** Throttle Stop Thumb Screw \$ 1.99
- E-4026** Barrel Valve Linkage Turnbuckle Assy \$ 16.99

Butterfly Colors
Black, Red, Blue,
Purple, Plain



- E-5004
- E-5001** SB Chevy Alum Front Cover \$ 128.99
- E-5002** SB Chevy Front Cover Seal \$ 15.99
- E-5003** SB Ford Alum Front Cover \$ 124.99
- E-5004** BB Chevy Alum Front Cover \$ 128.99
- E-5008** Chevy Hex Drive Assembly \$ 51.99
- E-5005A** 426 Hemi Hex Drive \$ 26.99
- E-4009** Bugcatcher Shaft \$ 90.99
- E-4010** Birdcatcher Shaft \$ 111.99
- E-4102** Buzzardcatcher Shaft \$ 124.99
- E-4102CF** Big & Ugly Shaft \$ 128.99
- B-5019** Hat Injector Stud & Nut Kit (4pc) \$ 11.99

Fuel Distribution Blocks

Distribution Blocks feature a black billet aluminum housing and includes fittings. Machined for use with a primer check valve.

- E-4027VW** Block w/ 4 fittings \$ 36.99
- E-4027** Hat Block w/ 8 fittings \$ 69.99
- E-4028** Port Block w/ 8 fittings \$ 63.99
- E-4028A** Port Block w/ 12 fittings .. \$ 75.99



Injector Hat & Port Line Sets

- E-855** Crimping Tool \$ 239.99
- E-DFL03** 3/16 Hose ft \$ 1.99
- E-620** 3/16 Ferrule \$.68
- E-KFO3** Str Hose End \$ 3.99
- E-KFO3-90** Hose End \$ 16.99
- Assembled Line Sets** (Set of 8)
- E-4031** Hat SS \$ 119.99
- E-4034** Hat Rubber \$ 119.99
- E-4036** Port SS from \$ 161.99
- E-4035** Port Rubber \$ 126.99

Complete Port Kits \$ 415



Complete with:
Nozzle Jets and Bodies, SS Lines (or hoses), Dist Block & AN8 Check Valve.



Available with Rubber Hoses .. \$ 379

Need a Tune up? Call or email us - No Charge!

Billet Y-Blocks



Gas
E85
Alky
Nitro

Billet Aluminum
Black Anodized
Single Inlet
Dual Outlets from
Fuel or Oil \$55

- FI-2110** AN8-6 **FI-2112** AN10-8 **FI-2116** AN12-10 **FI-2116** AN12-10

Check Valves



Brass check valves feature a one-way, spring-loaded poppet design. PSI is varied by springs and shims.

- AN6 Check Valves \$ 40.99
- AN8 Check Valves \$ 59.99
- Primer Check Valve AN4 \$ 23.99
- AN6 Spring & Shim Kit \$ 19.99





Large Selection
Discounted Prices

800/576-7661

Bypass Pills, Nozzle Jets, Holders

Enderle **Bypass Pills** are the "Screw-In style" and are designed to divert fuel away from the engine. The larger the pill, the leaner the mixture.



Best Seller

Install pills without damaging. Stores 8 pills.

E-7009.SD Driver **\$34.99**



Alum storage holder is a convenient place to store up to 40 bypass pills.

E-7010 Holder **\$17.99**



Sizes:
.020 to .209

E-7009 Bypass Pill **\$3.99**



Hi-Speed kit .050-.095 **\$37.99**

Enderle **Nozzle Jets** are the "Screw-In" style



Anodized aluminum storage holder is a convenient and safe place to store up to 60 jets.

Sizes: .016 to .110

- a. E-7007 Brass Nozzle Jet **\$ 5.45**
- a. E-7007A Flowed Nozzle Jet **\$ 8.35**
- b. E-7121A Port Nozzle Body **\$ 10.99**
- b. E-7130A Ball Check Port Body **\$ 18.99**
- c. E-7110A Top Nozzle Body **\$ 10.99**
- d. E-7011 Jet Storage Holder **\$ 21.99**

On-Board Self Primer System

Special 4psi check valve controls fuel.
Choice: Stainless-Steel or 1qt Poly tank.
Prime mechanical fuel injection from inside the driver's cockpit.



Kit Includes

- Fuel Cell
- Primer Check Valve
- 5' Premium Hose
- Hose Fittings



FI-5134 SS System w/o pump **\$ 99.99**

FI-5135 SS System w/ 12 Volt pump **\$135.99**

Injector Hat Spacer & Adapters



Billet Adapter

Allows one to bolt a smaller hat (13.25" bolt pattern) to a large blower (15.25" bolt pattern).

E-BS2 2in Injector Spacer **\$ 99**

E-BS3 3in Injector Spacer **\$103**

B-9055 Billet Hat Adapter **\$169**

B-6019 Hat Stud Kit **\$ 12**



Polished Spacers
Height: 2 or 3"
C-C: 13.25"
Includes Hardware

Hi-Flow Adapter

Machined from billet aluminum & o-ringed. Accepts Enderle or Hilborn hats & carb adapter plates. 2" high & 3" forward offset for improved airflow.



New!



B-9058 Polished
B-9059 Anodized Black **\$ 398**

Includes O-ring and Mounting Hardware !



Bob Hawkins

Same Day, Low Cost
Fast Worldwide Shipping!

800/576-7661

Barrel Valves

Enderle Barrel Valves can be used on Gas, E85, Alky, Nitro.
Available for Blowers & Naturally Aspirated.



- E-MVORM O-Ring Kit (Specify Style) \$ 10
- E-4018 Gas Metering Piston \$ 77
- E-4018-32 Tunnel Ram Metering Piston \$ 77
- E-4019 Alcohol Metering Piston \$ 77
- E-4020 Nitro Metering Piston K-Style \$ 98
- E-4020A Alky Metering Piston K-Style \$ 98
- E-4023 Barrel Valve Assy Square-Style Alky \$ 288
- E-4024A Barrel Valve Assy K-Style Alky \$ 342
- E-4024A.PSI Barrel Valve Assy K-Style PSI \$ 342

Barrel Valve Leakdown

- * Block off all injector lines & returns except for hat nozzles
- * Connect dual gauge tester to outlet of compressor
- * Set air compressor to read 0% on 2nd gauge
- * Connect tester to inlet of barrel valve
- * Read % leakage on 2nd gauge
- * Adjust linkage turnbuckle for desired %
(Lengthen to Richen, Shorten to Lean)



Leakdown Tester

Professional Grade
T-2003

Includes Injector Hose (AN6 or 8)

Dual Gauge Leakdown Tester



Injector Hose \$19

T-2006 AN6 T-2008 AN8

12V Electronic Fuel Lean-Outs



- * More Top End MPH
- * Accepts Enderle Pills
- * Converter Helper
- * Low Draw



As a high-speed lean out, this valve can be activated with an RPM activated switch, timer or momentary switch. Fuel will be taken away at the top end for best horsepower. What's a "Converter helper"? When a fuel injected motor is on a rev-limiter, the motor cools down severely since a large quantity of fuel is not being burned. This valve can be wired to the transbrake circuit so that when the transbrake is set, the valve opens and keeps the motor hot, lean and mean while on the rev-limiter.

FI-5101 Lean Out FI-5103 Enrichment **\$239**

Hi-Speed Assembly

Bleeds off fuel at higher rpm. Frees up top-end horsepower. Install anywhere between pump and distribution block. Variety of Pressures Available. Accepts Enderle Bypass Pill.



E-7019 Unblown AN6 Tee E-7018 Blown AN8 Tee

Toll-Free Tech Advice & Online "How-To-Videos"

Call or Click !



800.576.7661
DragParts.com





Premium Fuel Filters

Anodized *Black* or *Red*

System One filters are made from billet alum and feature a reusable 30 micron SS filter. Handles high pressure without volume loss.

Race - Long 2 x 9" \$151	Race 2 x 6" \$125	Pro-Street 2 x 4" \$99
AN6 SYS-202-202406	SYS-201-203406	SYS-200-201406
AN8 SYS-202-202408	SYS-201-203408	SYS-200-201408
AN10 SYS-202-202410	SYS-201-203410	SYS-200-201410
AN12 SYS-202-202412	SYS-201-203412	

Replacement SS Elements from **\$51**

Fuel Filters with Shutoffs

Designed to mount before the pump. AN12 female ports and a reusable #40 stainless steel screen. Foot pad is tapped with 1/4 -20 threads for easy mounting.



E-4056 w/o Shutoff **\$68** E-4057 **\$104**

Gas, E85, Alky & Nitro



100 Micron
SS Element
Female AN12
AER-12332 .. \$237



Viton O-Rings
60 or 120 Micron
2.50" x 3.90"

Gas, E85, Alky, Nitro

X-7106SAN.60	60 Micron AN6	\$149
X-7108SAN.60	60 Micron AN8	
X-7110SAN.60	60 Micron AN10	
X-7112SAN.120	120 Micron AN12	



Internal Mount AN12
Gas, E85, Alky
X-980012FS \$32

JAZ economical inline billet aluminum *filters* are 5in long and feature a 35 micron element.

Gas Only \$45

JAZ-836-006-11	AN6	
JAZ-836-008-11	AN8	
JAZ-836-010-11	AN10	
JAZ-836-001-11	3/8" Barb	

Hydrometers



Complete with: Hydrometers, Glass Beaker, Thermometer, Padded Case and Instructions.
Also checks: Gas, Methanol & Ethanol.

Hydrometer Kits

T-1200 Gas & Alky. 1 Hydrometer	\$ 198
T-1203 0-30 Nitro. 2 Hydrometers	\$ 225
T-1204 0-60 Nitro. 3 Hydrometers	\$ 251
T-1205 0-100 Nitro. 4 Hydrometers	\$ 278

Hydrometer Only

T-1210 Hydrometer Gas-Methanol	
T-1213 Hydrometer 5-30% Nitro	\$29.99
T-1215 Hydrometer 30-60% Nitro	
T-1217 Hydrometer 60-100% Nitro	

Components

T-1220 Padded Case	\$ 89
T-1222 Glass Beaker	\$ 42
T-1224 Thermometer	\$ 57

*Used by
Successful
Pros &
Sportsmen*

Pressure Gauge

Liquid Filled
Boost, Oil, Fuel



**1.5 in
Diameter**

Gauge	X-710000 .. 0-15psi
Only	X-710030 .. 0-30psi
	X-710060 .. 0-60psi
\$39.99	X-710100 .. 0-100psi

Blower Boost Memory Kit .. \$ 45

Records Highest Reading

B-5130 (Gauge not included in kit)

Injector De-Icer

Spray directly onto Injector Butterflies to prevent sticking & freezing.
11oz Aerosol



FI-7150 .. \$ 6.99

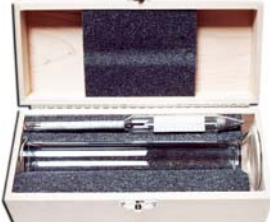

Nitro Sizes
0 - 50%
50 - 100%

E-7012 Hydrometer Kit Gas/Alky ..	\$ 165
E-7013 Hydrometer Kit Nitro	\$ 176
E-7014 Nitro Hydrometer only	\$ 68
E-7014B Gas/Alky Hydrometer	\$ 57
E-7015 Beaker only	\$ 43
E-7016 Wood Case	\$ 77



FREE Catalog!

800/576-7661



FI-5113 Most Hats
FI-5114 PSI Hat

\$ 98



FI-5111 Most Hats

\$ 79



6061 Billet Aluminum
Provision for Springs.
Fits Blower &
Tunnel Ram Injectors.
TF/TA Approved.

*(Swingover hookclamp
optional on F-5111)*

BILLET Throttle Cable Brackets

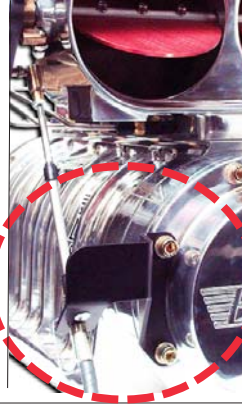

Works with Bug or Bird.
Anodized Aluminum.
Mounts to front of Blower.
Swingover Hook clamp.
Provision for Springs.

FI-5110
\$ 35



QR Throttle Stop

Quick Release in < 1 Second
Billet Aluminum w/ SS Pin
Top Fuel & Alcohol Legal

FI-5120 **\$ 59.99**

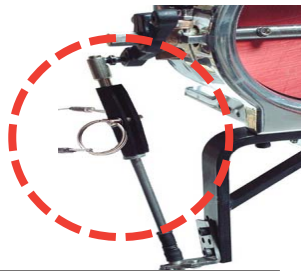

Premium Return Springs **\$6.99**

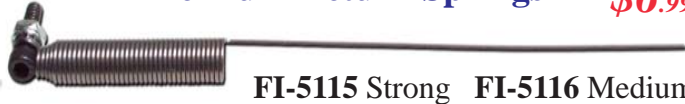

FI-5115 Strong **FI-5116** Medium

Special bend prevents spring from detaching from
Injector. Includes Grade 8 10-24 bolt & locking nut.

Tunnel Ram Linkage Kits

Everything needed
for mounting **Dual
Carbs** on a Tunnel
Ram *Side-Saddle*.

\$ 119.99

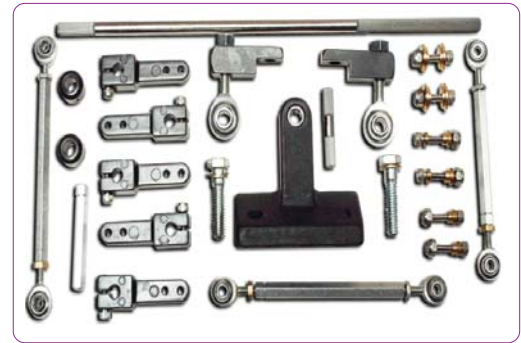

E-72-2000 SBC
E-71-1000 BBC

E-75-107 Ford 351C
E-75-220 Ford 460



Adjustable Bell Crank Assembly

Billet Aluminum
Stainless-Steel Fasteners

E-34-500 **\$62.99**

Injector Hat Linkage Kit

\$ 98.99



Designed to work with mechanical fuel injection
(Bug or Birdcatcher) on blown applications only.
Adjustable heim end design and needle bearings
for smooth throttle operation. **E-76-GVIHL**

Carb Linkage Kits

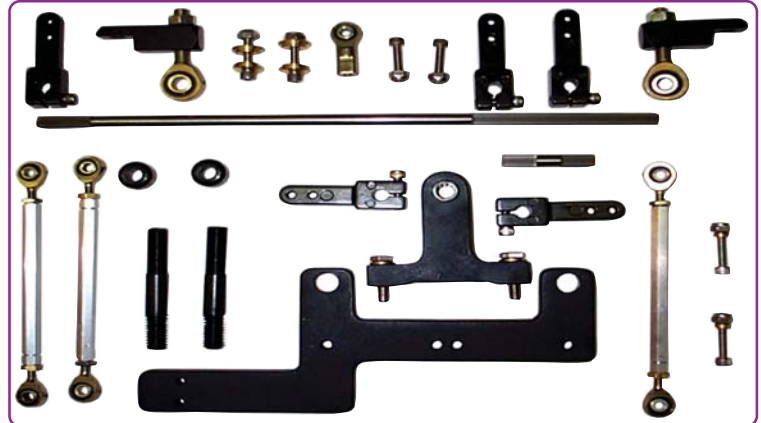

Blower Linkage Kits **\$ 119.99**

For dual Holley double-pumpers, Dominators, Predators & Carters mounted *Side-Saddle*. Includes adjustable heim-end design and needle bearings for smooth throttle operation. **E-76-107**

For dual Holley vacuum secondary, Dominators, Predators & Carters mounted *Inline* on a 8 9/16 center-to-center distance. Includes adjustable heim-end design and needle bearings for smooth throttle operation. **E-55-501**



Extensive Cable
Selection Online



800/576-7661

Determine Correct Cable

1. Select The Housing Style
2. Measure the Length (Tip to Tip)

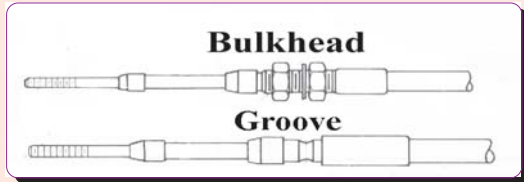

**Custom Length Cables?
No Problem!**

24" Throttle Cable



CC-UV-100-24 Nylon Housing **\$24.99**

CC-UV-200-24 Stainless Steel **\$29.99**

*** Cables can be Shortened ***



**18'
Chute
Cable**

Stainless Steel **CC-PCTG-216 .. \$ 34**
Center Wire **With Lever .. \$ 41**

Cable Brackets

Billet Aluminum & Lightweight

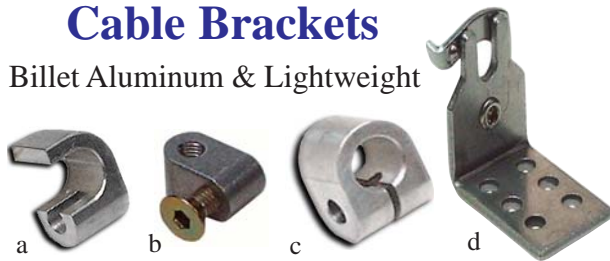

- a. **C-8512** Billet Half Clamp
- a. **C-8510** Billet Chute Clamp .. **\$7.99**
- b. **C-8507** Chute Pivot.....
- c. **C-8515** Billet Full Clamp
- d. **C-8520** Steel Swing Hook Clip **\$9.99**

The Choice of the Pros in Top Fuel & Alcohol

- * **Threaded Male 10-32 Both Ends**
- * **Grooved or Bulkhead Housing**
- * **Stainless Steel Inner**
- * **Heavy Duty Quality**



Micro-Adjust



Micro-adjust cables are perfect for applications where a locking cable is desired (marine, high vibration, etc...) Cable can be locked at partial travel and incorporates a push-release button for easy adjustment.

Other 72in \$ 109
sizes 96 \$ 116
available 120 .. \$ 122
p/n CC-26V33DF-3

Grooved	<i>Grooved</i> Housing on Both Ends. * Throttle
Bulkhead	Double-Nut <i>Bulkhead Housing</i> on One or Both Ends. * Shifter
T-Handle	<i>Grooved</i> Housing on One End. <i>T-Handle</i> with Double-Nut <i>Bulkhead</i> on Driver's End. * Fire System, Fuel Shutoff

Length	Groove	Bulkhead	T-Handle
2 Foot (24")	\$ 46.99	\$ 58.99	\$ 73.99
3 Foot (36")	\$ 46.99	\$ 58.99	\$ 73.99
4 Foot (48")	\$ 49.99	\$ 61.99	\$ 76.99
5 Foot (60")	\$ 52.99	\$ 64.99	\$ 78.99
6 Foot (72")	\$ 55.99	\$ 67.99	\$ 81.99
7 Foot (84")	\$ 58.99	\$ 70.99	\$ 84.99
8 Foot (96")	\$ 60.99	\$ 73.99	\$ 87.99
9 Foot (108")	\$ 63.99	\$ 76.99	\$ 90.99
10 Foot (120")	\$ 66.99	\$ 78.99	\$ 93.99
11 Foot (132")	\$ 69.99	\$ 81.99	\$ 96.99
12 Foot (144")	\$ 72.99	\$ 84.99	\$ 99.99
13 Foot (156")	\$ 75.99	\$ 87.99	\$101.99
14 Foot (168")	\$ 78.99	\$ 89.99	\$104.99

Longer Cable Lengths in Stock!



- a. **CC-003BALL** Ball only 10-32 threads **\$1.98**
- a. **E-4011BS** Ball only SS 10-24 threads **\$5.63**
- b. **CC-175-403-0030** Q.D. Ball Joint w/ 10-32 **\$7.99**
- c. **CC-175-403-0024** Q.D. SS Ball Joint w/ 10-24 **\$10.99**
- d. **CC-165-172-307A** Round Knob 10-32 **\$6.99**
- e. **CC-CREF-3-3** Female Heim10-32 **\$6.99**
- f. **4130 Chromoly** Rod End Adapters **Varies**
- g. **CC-PCH-100** Aluminum Lever **\$6.99**

Cable Ends



Same Day, Low Cost
 Fast Worldwide Shipping!

800/576-7661

Billet Case Show Quality Blowers!

6.71 to 14.71



The Blower Shop superchargers are some of the finest on the market. Their **BILLET case** is superior to cast casings and has a show polished finish.

Proven successful in professional motorsports including: Drags, Marine and Tractor Pulling, Mega Trucks, Salt Flats



More Sizes, Prices & Info!



Competition race blowers are Hard Anodize, has 18 Strips of Teflon and Drilled for Rear Nozzles.

Blower Gel

Penetrating gel with Teflon is designed to lubricate and coat the rotors of Standard Roots superchargers. This formulated gel adheres to the rotors creating tighter tolerances thus, resulting in higher efficiency and increased boost levels.



Gas E85
 Alcohol
 Nitro

G-3150
 G-3152
\$17.99



Blower Drive Kits

Street Rods * Marine * Drag Racing
 Tractor Pulling * Mud Buggers

Our Blower Kits are some of the finest on the market. Show-Quality & Precision Machined.
Most kits include: Blower, Drive Kit, Manifold, Bolts, All Gaskets & Tech Support.



Drive Kits are in Stock! From **\$998**



B-7220
\$ 589

Blower Spacers

CAST

Manufactured from **cast** aluminum and designed to raise the blower 4 inches.
Includes: Gaskets and Aluminum Studs.

Options:

Burst Panel Machining w/ all Hardware



BILLET

Machined from **Billet** aluminum and designed to raise the blower 2 inches (can be stacked). O-Ring Groove on top.
Includes: O-Ring, Anodized Studs, Stainless Steel Washers and Nuts.



B-7234

\$ 465



B-7232



B-7222
\$ 749



Standard Features Include:

- * Raised tented floor for improved airflow.
- * Solid sides for added strength and rigidity.
- * Competition models has port nozzle provisions.
- * Most will accept 6.71 through 14.71

Blower Manifolds



B-7104 SB Chevy Race



B-7113 BB Chevy Street

Show Polishing on TBS
Most Add \$110

SBC

- B-7102 SB Chevy Street Large Port \$ 599
- B-7103 SB Chevy Street Weiland \$ 399
- B-7104 SB Chevy Race Large Port. All Hardware Including Alum Studs \$ 779

BBC

- B-7110 BB Chevy Race Std. Machined for burst panel. Hardware sold separate. \$ 716
- B-7112 BB Chevy Race Std. Machined for burst panel. All Hardware Included. \$ 781
- B-7114 BBC Race TALL deck. Machined for burst panel. Hrdwr sold separate. \$ 781
- B-7113 BB Chevy Street Weiland Std deck. Pop-off valve. Hardware Included \$ 403
- B-7116 BB Chevy Street Standard deck. Pop-off valve. Hardware Included \$ 533
- B-7118 BBC Street TALL deck. Pop-off valve. All Hardware Included \$ 597

FORD

- B-7127 429-460 Street or Race \$ 973

HEMI

- B-7153 331-392 Street Weiland \$ 569



B-7112

* Drilled for Port Nozzles

* Machined for Burst Panel

BB Chevy Race w/ Hardware 2.25" Setback



.450 Thick Billet Alum

B-7255 Retro Plate w/ Hardware \$224

Need Premium Gaskets?

See Page 21



Manifold Components

- a. B-7200 Swivel Thermostat Housing \$ 29.99
- b. B-5120 Billet Extrnl Thermostat Housing \$ 79.99
- c. B-5020 Steel Mounting Bolt Kit \$ 18.99
- d. B-5025.K Alum Blower Stud Kit 2.5" ... \$ 34.95
- e. B-5026.K Above with 12pt Nuts \$ 48.99

Premium Burst Panels

Standard size panels are **SFI** Approved. Very popular on Top Fuel & Blown Alcohol Engines.

2pc Aluminum Frame Kit

Designed to mount a burst panel onto a blower manifold. Includes 24 Stainless-Steel bolts.

PSI Blower Tandem Kit

Similar as above but also includes special aluminum center with side brass fitting for quick check of inner panel. Has 2 burst panels.

Burst Deflector

Billet aluminum deflector diverts potential explosions either up or down away from fuel lines and other fragile components. Has depth gauge provision for measuring panel expansion.

Burst Panel Adapters

Aluminum adapters can be either welded or bolted on a blower intake. Ideal for applications where there is not enough surface for the standard 2 pc frame kit. Accepts the standard size burst panel.



- B-5100 Burst Panel, SFI Approved \$ 24.95
- B-5100.3 Burst Panel *3 pack special!* \$ 65.99
- B-5102 2pc Alum Frame Kit w/ 24 bolts \$ 64.99
- B-5106 PSI Blower Tandem Kit \$ 194.99
- B-5112 Burst Panel Deflector \$ 164.99
- B-5109 Burst Panel Alum Adapter (Bolt-on) \$ 74.99
- B-5110 Burst Panel Alum Adapter (Weld-On) \$ 74.99



FREE Catalog!

800/576-7661

8 & 11mm

Drive Ratio Chart



**B
O
T
T
O
M
P
U
L
L
E
Y**

TOP PULLEY

	43	44	45	46	47	48	49	50	51	52	53	54	55	56
47	9.3	6.8	4.4	2.2	1.0	-2.1	-4.1	-6.0	-7.2	-9.6	-11.3	-13.0	-14.5	-16.1
48	11.6	9.1	6.7	4.3	2.1	1.0	2.0	-4.0	-5.9	-7.7	-9.4	-11.1	-12.7	-14.3
49	14.0	11.4	8.9	6.5	4.3	2.1	1.0	-2.0	-3.9	-5.8	-7.5	-9.3	-10.9	-12.5
50	16.3	13.6	11.1	8.7	6.4	4.2	2.0	1.0	-2.0	-3.8	-5.7	-7.4	-9.4	-10.7
51	18.6	15.9	13.3	10.9	8.5	6.3	4.1	2.0	1.0	-1.9	-3.8	-5.6	-7.3	-8.9
52	20.9	18.2	15.6	13.0	10.6	8.3	6.1	4.0	2.0	1.0	-1.9	-3.7	-5.5	-7.1
53	23.2	20.5	17.8	15.2	12.8	10.4	8.2	6.0	3.9	1.9	1.0	-1.9	-3.6	-5.4
54	25.5	22.7	20.0	17.4	14.9	12.5	10.2	8.0	5.9	3.8	1.9	1.0	-1.8	-3.6
55	27.9	25.0	22.2	19.6	17.0	14.6	12.2	10.0	7.8	5.8	3.8	1.9	1.0	-1.8
56	30.2	27.3	24.4	21.7	19.1	16.7	14.3	12.0	9.8	7.7	5.7	3.7	1.8	1.0
57	32.5	29.5	26.7	23.9	21.3	18.8	16.3	14.0	11.8	9.6	7.5	5.6	3.6	1.8
58	34.8	31.9	28.9	26.1	23.4	20.8	18.4	16.0	13.7	11.5	9.4	7.4	5.5	3.6
59	37.2	34.1	31.3	28.3	25.5	22.9	20.4	18.0	15.7	13.5	11.3	9.3	7.3	5.4
60	39.5	36.4	33.3	30.4	27.7	25.0	22.4	20.0	17.6	15.4	13.2	11.1	9.1	7.1
61	41.8	38.6	35.6	32.6	29.8	27.1	24.5	22.0	19.6	17.3	15.1	13.0	10.9	8.9
62	44.2	40.9	37.8	34.8	31.9	29.2	26.5	24.0	21.6	19.2	17.0	14.8	12.7	10.7
63	46.5	43.2	40.0	37.0	34.0	31.1	28.6	26.0	23.5	21.2	18.9	16.7	14.5	12.5
64	48.8	45.5	42.2	39.1	36.2	33.3	30.6	28.0	25.5	23.1	20.8	18.5	16.4	14.3
65	51.2	47.7	44.4	41.3	38.3	35.4	32.7	30.0	27.5	25.0	22.6	20.4	18.2	16.1
66	53.5	50.0	46.7	43.5	40.4	37.5	34.7	32.0	29.4	26.9	24.5	22.2	20.0	17.9
67	55.8	52.3	48.9	45.6	42.6	39.6	36.7	34.0	31.4	28.8	26.4	24.1	21.8	19.6
68	58.1	54.5	51.1	47.8	44.7	41.7	38.8	36.0	33.3	30.8	28.3	25.9	23.6	21.4
69	60.5	56.8	53.3	50.0	46.8	43.8	40.8	38.0	35.3	32.7	30.2	27.8	25.5	23.2
70	62.8	59.1	55.6	52.2	48.9	45.8	42.9	40.0	37.3	34.6	32.1	29.6	27.3	25.0

13.9mm/14mm
1/2" Pitch: 25-44T



**B
O
T
T
O
M
P
U
L
L
E
Y**

TOP PULLEY

	25	26	27	28	29	30	31	32	33	34	35	36	37
25	1.0	-3.8	-7.4	-10.7	-13.8	-16.7	-19.4	-21.9	-24.2	-26.5	-28.6	-30.6	-32.4
26	4.0	1.0	-3.7	-7.1	-10.3	-13.3	-16.1	-18.7	-21.2	-23.5	-25.7	-27.8	-29.7
27	8.0	3.8	1.0	-3.6	-6.9	-10.0	-12.9	-15.6	-18.2	-20.6	-22.9	-25.0	-27.0
28	12.0	7.7	3.7	1.0	-3.4	-6.7	-9.7	-12.5	-15.2	-17.6	-20.0	-22.2	-24.3
29	16.0	11.5	7.4	3.6	1.0	-3.3	-6.5	-9.4	-12.1	-14.7	-17.1	-19.4	-21.6
30	20.0	15.4	11.1	7.1	3.4	1.0	-3.2	-6.2	-9.1	-11.8	-14.3	-16.7	-18.9
31	24.0	19.2	14.8	10.7	6.9	3.3	1.0	-3.1	-6.1	-8.8	-11.4	-13.9	-16.2
32	28.0	23.1	18.5	14.3	10.3	6.7	3.2	1.0	-3.0	-5.9	-8.6	-11.1	-13.5
33	32.0	26.9	22.2	17.9	13.8	10.0	6.5	3.1	1.0	-2.9	-5.7	-8.3	-10.8
34	36.0	30.8	25.9	21.4	17.2	13.3	9.7	6.3	3.0	1.0	-2.9	-5.6	-8.1
35	40.0	34.6	29.6	25.0	20.7	16.7	12.9	9.4	6.7	2.9	1.0	-2.8	-5.4
36	44.0	38.5	33.3	28.6	24.1	20.0	16.1	12.5	9.1	5.9	2.9	1.0	-2.7
37	48.0	42.3	37.0	32.1	27.6	23.3	19.4	15.6	12.1	8.8	5.7	2.8	1.0
38	52.0	46.2	40.7	35.7	31.0	26.7	22.6	18.8	15.2	11.8	8.6	5.6	2.7
39	56.0	50.0	44.4	39.3	34.5	30.0	25.8	21.9	18.2	14.7	11.4	8.3	5.4
40	60.0	53.8	48.1	42.9	37.9	33.3	29.0	25.0	21.2	17.6	14.3	11.1	8.1
41	64.0	57.7	51.9	46.4	41.4	36.7	32.3	28.1	24.2	20.6	17.1	13.9	10.8
42	68.0	61.5	55.6	50.0	44.8	40.0	35.5	31.3	27.3	23.5	20.0	16.7	13.5
43	72.0	65.4	59.3	53.6	48.3	43.3	38.7	34.4	30.3	26.5	22.9	19.4	16.2
44	76.0	69.2	63.0	57.1	51.7	46.7	41.9	37.5	33.3	29.4	25.7	22.2	18.9
45	80.0	73.1	66.7	60.7	55.2	50.0	45.2	40.6	36.4	32.4	28.6	25.0	21.6

How to select your Belt & Pulley Sizes





Professional
Products
at Sportsman
Prices!



Extensive Belt
Selection Online

Supercharging ¹⁹

800/576-7661



Good Vibrations Motorsports is the "Official Supercharging of IHRA"



Scan to
see if
you're
eligible for
\$\$\$

Good Vibrations is posting over \$70,000 in
Contingency. Racers in most classes at ALL
National & Division races are eligible!



Blower Belts

Good Vibrations stocks one
of the largest selection of
blower pulleys & belts in
the world!



3" Belts listed. Other
widths in Stock



1/2 Pitch

Street/ Race < 15% OD

510H300	\$ 69
540H300	\$ 69
550H300	\$ 69
560H300	\$ 69
570H300	\$ 69
585H300	\$ 79
600H300	\$ 79
630H300	\$ 79
660H300	\$ 79
700H300	\$ 79



8mm & GT

Street/ Race < 35% OD

1280M75	\$ 89
1360M75	\$ 83
1440M75	\$ 89
1520M75	\$ 94
1600M75	\$ 99
1696M75	\$ 109
1760M75	\$ 109
GT Street/ Race > 35% OD	
1440M75GTC	\$ 188
1440M75PS	\$ 229
1512M75GT2	\$ 149
1600M75GTC	\$ 208
1600M75PS	\$ 233
1792M75PS	\$ 262



14mm & GT

Street/ Race > 35% OD

1400M75.....	\$ 217
1568M75GTC	\$ 323
1568M75GTPS	\$ 332
1610M75	\$ 218
1610M75KEV	\$ 324
1610M75PS	\$ 359
1694M75 KEV	\$ 393
1694M75PS	\$ 335
1750M75GTC	\$ 363
1778M75	\$ 233
1778M75KEV	\$ 438

In Stock!

13.9mm

1543M75 \$ 211

Billet Alum Blower Pulleys

* Pulleys are 3.5" wide with 2" center register.

* Billet 6061 aluminum and T-6 heat treated.

Hard anodizing is standard on:

8mmGT, 11mmGT, 13.9 and 14mm/ GT pulleys.



Discounted Prices
& Huge Selection
ONLINE

8, 11 & 14mmGT Pulleys are
available in Center Flange



Ratios > 35%
Sizes: Varies
From \$ 158

					
2 or 2.25" Hole					
1/2 Pitch	8mm	8mmGT	11mmGT	13.9mm	14mm & GT
Ratios < 15% Sizes: 26-44 From \$ 72	Ratios < 35% Sizes: 42-71 From \$ 72	Ratios > 35% Sizes: 42-80 From \$ 97	Ratios > 35% Sizes: 32-53 From \$ 95	Ratios > 35% Sizes: 25-45 From \$ 83	Ratios > 35% Sizes: 25-46 From \$ 83

Blower Components



Hundreds of
Parts Online

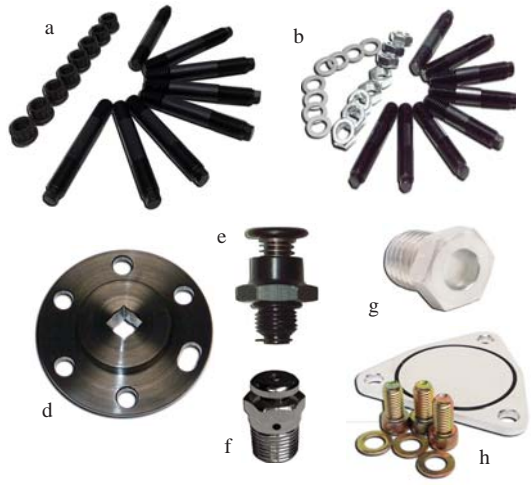
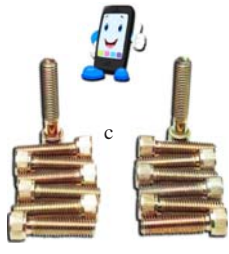

- a. **B-5026.K** Blower Stud Kit 2.5" w/ 12pt Nuts \$ 49
- b. **B-5025.K** Blower Stud Kit Alum 2.5" Hex Nuts \$ 35
Longer Blower Studs 3.00" & 3.50" (each) \$ 5
- c. **B-5020** Blower Bolt Kit Steel. Grade 8 (Set of 8) \$ 35
- d. **B-5038** Aluminum Blower Turning Plate \$ 35
- e. **B-5136** Pressure Relief Valve 7/16 Alum Black \$ 17
- f. **B-5135** Pressure Relief Valve 1/8 Stainless Steel \$ 16
- g. **B-5138** Oil Level Sight Gauge Lexan 1/4 NPT \$ 18
- h. **B-5140** Billet Tri-Plate Kit w/ Bolts & Oring \$ 19

Street Snouts
are Polished !



Shaft Size
Street 1.125
Race 1.250



Includes Grade 8
Bolts & Washers

Blower Snouts

Drive Snouts are machined from billet aluminum. Has double ball bearings and HD oil seal. 48-Tooth spline shaft is made from heat-treated 4100 steel.

- Street Snouts**
- B-5300** Street Snout 3.90" \$ 298
 - B-5310** Street Snout 5.75" \$ 338
 - B-5302** Coupler for above \$ 87
 - B-5317** Street Snout 8.125" \$ 398
 - B-5319** Coupler for above \$ 99
- Race Snouts**
- B-5340** Race Snout 3.90" \$ 289
 - B-5342** Coupler for 3.90" \$ 75
 - B-5350** Race Snout 5.25" \$ 299
 - B-5352** Coupler for 5.25" \$ 79
 - B-5360** Race Snout 6.00" \$ 339
 - B-5362** Coupler for 6.00" \$ 85
 - B-5370** Race Snout 7.00" \$ 359
 - B-5372** Coupler for 7.00" \$ 89

Blower Front Covers

Billet 6061-T6 Aluminum

- B-5220 All Round
 - B-5224 Half-Round Corners
- Fits most brands of blowers*



Satin Finish .. \$ 189
Polished \$ 209

Blower Bearing Plates

Rear plate includes:
Heat-Treated dowels
& Bearing Caps (pr).
POLISHED !



- TBS-1160** Billet \$ 199
- TBS-1169** Cast \$ 179

Quick-Connect Burndown Tubes

Anodized Aluminum
Positive Locking
Heat-Treated Flanges



Also Available
10 Degrees
Left



\$186
Set

Angled Hemi
C-7152

NHRA
IHRA
Approved
Straight
C-7150



Polished Aluminum Upright
Breathers w/ 1.25" Ends

New!

C-7197 \$169 Pair

Flat Breather Hose

Fits 1.25 to 1.50" hose.
Lightweight & Flexible
B-5126 \$3.25/ft



Clear Breather Hose

Works with all fuels.
B-5125 1.250" \$5/ft **B-5127 1.500" \$6/ft**





Belts Guards



800/576-7661

Blower Gaskets

These premium gaskets are race tested and proven in Top Fuel/ Alcohol & Blown Gas.

Blower Base

- G-2022 6.71 \$ 9
- G-2022.3 3-Pack ... \$ 18
- G-2028 8-10.71 ... \$ 9
- G-2028.3 3-Pack \$ 24
- G-2032 14.71 \$ 12
- G-2032.3 3-Pack \$ 32



Blower Inlet

Re-Usable!

- G-2012 Small w/o Screen \$ 7
- G-2012.3 3-Pack Special \$ 15
- G-2014 Small w/ Screen \$ 9
- G-2014.3 3-Pack Special \$ 22
- G-2016 Large w/o Screen \$ 7
- G-2016.3 3-Pack Special \$ 15
- B-5019 Inj Hat Stud Kit \$ 12



Blower Front Cover



- G-2058 Blower Snout \$3
- G-2059 w/ Bolts \$ 5

Blower Bearings ea.

- G-3312 Rear \$ 14
- G-3314 Front \$ 17
- Blower Seals ea.**
- G-3300 Standard \$ 8
- G-3302 Oversize \$ 8
- G-3304 Shaft Saver \$ 5
- Bearing/Seal Kits (4ea)**
- G-3320 Street \$ 89
- G-3322 Race \$ 119

Blower Snouts

- G-2060 Seal 1.125 \$ 8
- G-2062 Seal 1.250 \$ 15
- G-2061 Bearing 1.125 \$ 19
- G-2063 Bearing 1.250 \$ 19



- G-3020 3/32
- G-3022 1/8
- G-3023 1/8 O/S
- G-3024 3/16



BUNA O-Ring Material
Ideal for sealing Manifolds, Heads, etc..
Gas - E85 - Alky - NITRO
.95/ft

Belt Guards & Components

Bolts Right on! No Add't Hardware Required

Billet Aluminum
Stainless Steel Fasteners
Polished **or** Black Finish

Roots & Screws \$139
B-5006 Polished B-5006.B Black

3-Hole SSI & PSI ... \$159
B-5015 Polished B-5015.B Black

Widths In Stock: 6, 7.5, 8.5, 10, 12"

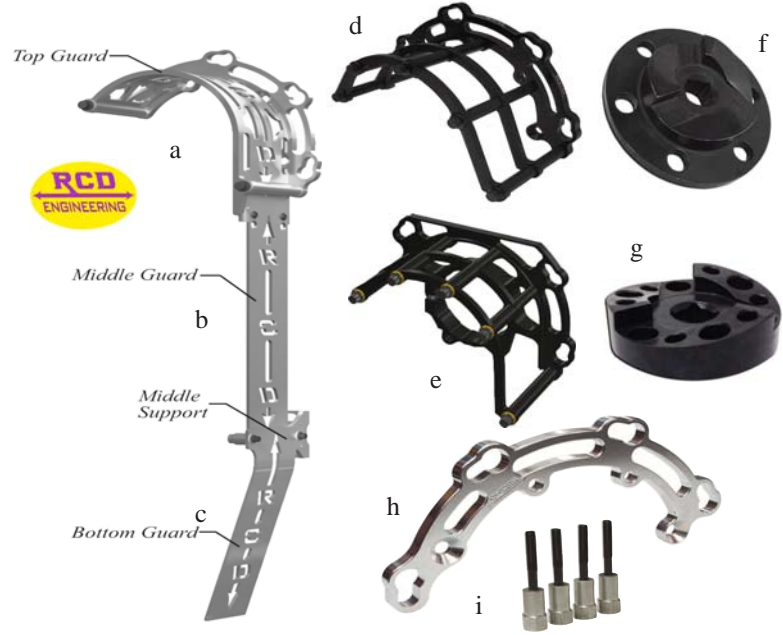

- RCD-103507-0010 Top Belt Guard, SSI 3-Hole \$ 176
 - RCD-103507-0018 Top Belt Guard, Snout Mntd \$ 187
 - RCD-157019-15 Snout Mounted Guard Clamp \$ 151
- (Specify with or w/o Starter Bracket for Belt Guards)

- a. RCD-103507-0004 Top Belt Guard, Roots \$ 178
- b. RCD-103512-10 Middle Belt Guard \$ 50
- c. RCD-103522-0003 Lower Belt Guard \$ 154
- d. RCD-103507-0002 Top Belt Guard, Roots HD .. \$ 216
- e. RCD-103507-0030 Top Belt Guard, Clamp HD .. \$ 439
- f. B-5040 Starter Dog 6-Hole Roots Steel \$ 69
- g. B-5042 Starter Dog PSI Blowers Steel \$ 139
- h. RCD-103507-03 Blower Starter Face Plate \$ 73
- i. **Belt Guard Mounting Kit** For RCD Guards from \$ 55

Mounting Kits: Standoffs Available from 1.75" - 4.00"



FREE Catalog!

800/576-7661

Chromoly Crank Hubs

Hubs are designed to replace your harmonic balancer. Machined from 4100 steel and broached for 2 keyways.

Prices Reduced!



Internal Balance



External Balance



Hub with optional Degree Ring Installed



Int Bearing Support 426 Hemi



429-460 Ford



426 Hemi PSI/RCD Spline



Crank Hub w/ V-Groove

Race Tested & Proven in Top Fuel and Alky!

- B-2040** SBC Int Bal 3/16-1/4 Keys **\$ 109**
- B-2041** SBC Int Bal w/ V-Groove **\$ 158**
- B-2042** SBC Ext Bal 3/16-1/4 Keys **\$ 199**
- B-2053** BBC Int Bal 3/16-1/4 Keys **\$ 109**
- B-2054** BBC Int Bal Dual 1/4 Keys **\$ 109**
- B-2051** BBC Int Bal w/ V-Groove **\$ 158**
- B-2055** BBC Ext Bal 3/16-1/4 Keys **\$ 199**
- B-2056** BBC Ext Bal Dual 1/4 Keys **\$ 199**
- B-2060** Hemi 426 PSI Spline **\$ 169**
- B-2064** Hemi 426 Dual 1/4 Keys **\$ 109**
- B-2066** Hemi 426 Internal Brng Sppt **\$ 269**
- RCD-202803-04** Hemi 354-417..... **\$ 198**
- B-2080** Ford 429-460 Dual 1/4 Keys **\$ 109**

Crank Bolts 7/16 - 1/2 - 3/4"



From.. **\$38**

Chrome-Moly Steel
 Black Oxide Finish
 Gun Drilled
 Heat-Treated

Chevy
 Hemi
 Ford

Minimize Crankshaft Flex & Bearing Damage

Front Bearing Supports



**Bearing Problem?
 Get Support!**

- * Chrome-Moly Crank Hub
- * Billet Aluminum Plate & Standoffs

Bearing Supports

- B-2435** Bearing Support SBC **\$ 484**
 - B-2455** Bearing Support BBC **\$ 484**
 - RCD-202600-0004** Bearing Support 426 HEMI **\$ 741**
 - RCD-202800-0002** Bearing Support 392-417 HEMI **\$ 686**
- (Add \$70 for Anodized Black Supports)

Long Crank Hubs for Bearing Support

- B-2046** Crank Hub SBC 3/16 & 1/4 Keyways **\$ 329**
- B-2057** Crank Hub BBC 3/16 & 1/4 Keyways **\$ 329**
- B-2058** Crank Hub BBC Dual 1/4 Keyways **\$ 329**
- B-2067** Crank Hub 426 HEMI Dual 1/4 Keyways **\$ 329**
- RCD-202803-0020** Crank Hub 392-417 HEMI **\$ 439**

Billet Crank Washers

Chromoly. Perfect Fit
 SB & BB Chevy & Mopar



.500
 .750
\$10 Hole

Billet Crank Hub Degree Rings



Standard



Offset

Billet Aluminum
 6.375 or 7" Diameter
 1 Degree Increment

w/o Magnets

- B-2032** 6.375" **\$ 69**
- B-2034** 7.000" **\$ 69**

with Magnets

- B-2033** 6.375" **\$129**
- B-2037** 7.000" **\$129**
- B-2038** 7.000" Offset **\$179**

Crank Hub & Gear Remover



T-1112 \$157

This tool allows one to safely remove the blower crank hub or harmonic balancer. Unlike some lightweight models, the remover is heat-treated and built tough. It also has a provision for removing the crank gear. Proven many times over by Top Fuel teams.



**Professional
Products
at Sportsman
Prices!**



Crank Hubs

Supercharging ²³

800/576-7661

Crank Triggers

100% coverage foil-shield, twisted pair cable for max noise rejection. Covered with fire-sleeve. The coil is precision wound on a nylon bobbin for long life. Employs a separate 16" ground wire for shielding and max radio frequency and electromagnetic noise rejection. **Can be trimmed to fit** and grounded to the chassis or motor. Highest quality **gold-plated terminals** in the plug ensures that the connection stays corrosion free. Pickup sensors have a smooth diameter and fit perfectly in most 3/8" pickup holders.

Adapter allows one to adapt 3/4"-16 style pickup brackets to the smooth 3/8" pickups (usually used with straight pickups).

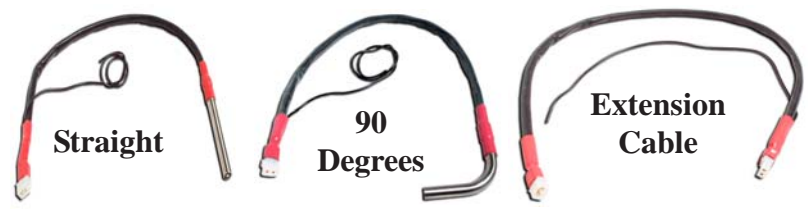

**Online Parts
& Technical**

- I-3118 Pickup Straight 18" \$ 125
- I-3126 Pickup Straight 26" \$ 125
- I-3218 Pickup 90 Deg 18" \$ 125
- I-3226 Pickup 90 Deg 26" \$ 125
- I-3102 Extension Cable 24" \$ 30
- I-3103 Extension Cable 36" \$ 30
- I-3201 Pickup Adap 3/4-16 to 3/8 \$ 41

Trigger Brackets \$69

Crank Trigger Brackets are machined from billet aluminum. Designed to mount to the right side (passenger) or left side (driver). Utilizes the smooth Pickup Holders.



- I-3310 SBC Right
- I-3312 SBC Left
- I-3314 BBC Right
- I-3316 BBC Left
- I-3318 Hemi Right
- I-3320 Hemi Left

**Billet
Alum
Spacers
\$10**

Pickup Holders

Crank Trigger Pickup Holders are machined from billet aluminum and are designed to hold the 3/8 threaded or smooth pick-ups.



Slides into: SBC, BBC, Hemi Trigger Brackets

- I-3300 3/8 Smooth -SBC
- I-3303 3/8 Smooth -Others

Billet Pointers

Pointer Assembly is machined from billet aluminum and is adjustable by 14°. Designed for a 7" degree ring and allows precise reading of the engine timing. NHRA Legal.

Fits HEMIs (TFX, BAE, etc..)



Hemi 7" RCD-202000-0010

\$39

Machined from billet aluminum and is adjustable. Will work on 6 3/8 or 7in degree ring. Allows for precise reading of engine timing. Includes mounting hardware. One of the nicest pointers on the market.



Adjustable!
B-2020 SB Chevy B-2022 BB Chevy

\$59

V-Groove Pulleys

V-Groove Pulleys are machined from billet 6061-T6 alum. Has a 2" register and bolts directly to crank hub with 6 bolts. Can be stacked together for PS, AC, etc...

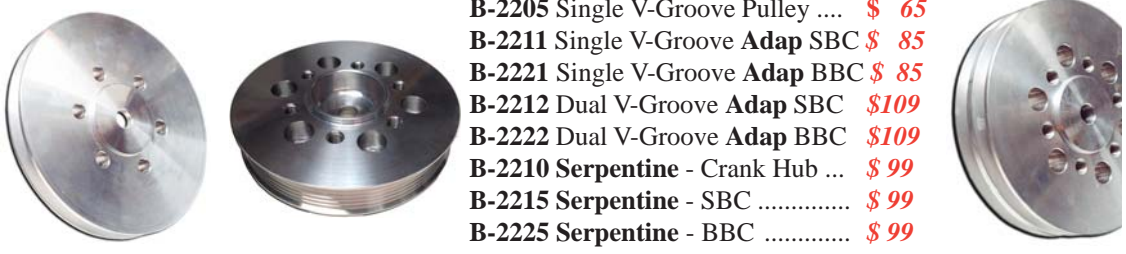

- B-2205 Single V-Groove Pulley \$ 65
- B-2211 Single V-Groove Adap SBC \$ 85
- B-2221 Single V-Groove Adap BBC \$ 85
- B-2212 Dual V-Groove Adap SBC \$109
- B-2222 Dual V-Groove Adap BBC \$109
- B-2210 Serpentine - Crank Hub ... \$ 99
- B-2215 Serpentine - SBC \$ 99
- B-2225 Serpentine - BBC \$ 99

Adapter-style pulleys bolts directly to balancers. Available in Single or Double V-Grooves & 5 and 6.25" diameter.

Blower Pulley Spacers

Allows one to easily align both upper and lower blower pulleys.



2" Center Register
Billet 6061 Alum
6 Hole Pattern
Widths: .300 - 1.40"
from \$ 19.99

Accessory Pulleys



**Billet Aluminum
Uppers are Polished**

- B-2230 Water Pump SBC \$ 40.95
 - B-2233 Water Pump BBC \$ 40.95
 - B-2236 Lower Pulley BBC \$ 30.95
 - B-2240 Alternator SB Chevy \$ 23.95
 - F-312-1000SS SS WP Bolt \$.81
- Fits **Short** Water Pumps

Same Day, Low Cost
 Fast Worldwide Shipping!

800/576-7661

Proudly Made in USA

Billet Idler Pulleys and Brackets

Complete Bracket Listing Online



Billet Idler Pulley



3.25 or 4.5in Diameter

Includes: Idler Pulley, Alum Standoff and Washer.

Machined from 6061-T6 alum. Feature an offset double ball bearing allowing for further spacing from bracket. Crowned center helps keep blower belt centered.



Anodized Black **Add \$10**

- B-6092** 2" wide x 3.25" **\$ 129**
- B-6095** 3" wide x 3.25" **\$ 129**
- B-6096** 3" wide x 4.50" **\$ 159**
- B-6097** 3.3" wide x 3.25" **\$ 139**

Idler Pulley Spacers

Billet Aluminum & Anodized



Spacer Widths
 .400 to 1.400

From \$11

Tee Nut

Offset allows for more adjustment



- B-6090** .75 **\$25**
- B-6091** 1.00

Engine Mounted Kits

Includes: Polished Alum Bracket, Water Standoffs (Drilled & Tapped AN8), Mounting Spacers & Bolts, Idler Bolt & Chromoly T-Nut.

- B-6041** SB Chevy Kit **\$ 199**
- B-6051** BB Chevy Kit
- B-6040** SBC Bracket **\$ 109**
- B-6050** BBC Bracket



Outboard Support Kit BBC & Hemi

Includes: Alum Bracket, Outboard Support, 3.10 or 3.35" Idler Pulley, .750 Bolt, 1.00in T-Nut and Hardware.



Mount for Dunn Offset Mag Drive



- B-6065** Hemi Kit **\$449**
- B-6055** BB Chevy Kit **\$449**
- B-6067** Dunn Mount **\$ 99**

Blower Mounted



Prices Reduced!

Billet L-Shape bracket mounts directly to the front of most roots blowers.

Kit Includes: Bracket, T-Nut, Bolts and Alum Standoffs.

- B-6000** Bracket Only **\$ 65**
- B-6001** Standard Kit **\$ 128**
- B-6002** Long Kit **\$ 138**

Long Kits include .700 spacer & longer bolt.

Bracket Spacers

Billet Aluminum .375 ID

From \$5

Lengths:

.25 .75 1.00 1.50 2.00 2.375

Large Variety of Applications



Swing Arm

Billet Swing Arm Bracket clamps to snouts (with 3.38" OD). Allows one to adjust the idler pulley For and Aft.



- B-6007** Billet Arm **\$ 119**
- Idler Bolt** 5/8-11 x 4" **\$ 7**

Hemi Engine Mounted Bracket



392 Hemi



426 Hemi

Mounts to Engine Block. 3/4" Aluminum Prevents Warpage.

- B-6060** 426 Hemi **\$ 166**
- 156206-09** 392 Hemi **\$ 169**

HEMI Outboard Support Bracket Angled w/ T-Nut & Mounting Hardware.

BAE, KB, TFX

*Idler pulley & Outboard Support not included



B-6062 Hemi **\$215**



Carb Scoops

800/576-7661

Carb Scoops

Fits Blowers & Most Tunnel Rams



Scoops are replicas of the famous Bugcatcher Injector. Designed to fit single or dual carbs. Highly polished with anodized butterflies.

Complete with Mounting Hardware and Filters!

\$249

Dual Carbs:

7.75 - 9.25 c-c

ACC-2522 .. Smooth ACC-2520 .. Ribbed

Hilborn-Style

Hilborn-style scoops are designed for single or dual carbs on **Tunnel Rams & Blowers.**

Polished (or Black) Finned or Smooth top.

Includes: Adjustable mounting hardware, front screen & filter(s).



ACC-2527 Single Carb **\$ 129**

ACC-2525 Dual Carb **\$ 149**

ACC-2523 Shotgun-Style .. **\$ 249**

Blower Only Scoops

Polished aluminum **Dual Carb** scoop for **Standard** four-barrel style carbs **mounted inline** or **side-saddle** on 8 5/8" centers. (Won't fit most Tunnel Rams)

B-9070 Dual Carb Blower Scoop **\$ 261**

B-9072 Above w/ Filters **\$ 324**

B-9072.BLK Black w/ Filters **\$ 391**

B-9074 Filter w/ Top, Stud & Nut **\$ 41**

Carb Adapter Plates

Dual four barrel carb adapter plate for a 6.71 or 8.71 blower. Accepts two **Standard** Holley carbs sidesaddle or Carter carbs inline on an **8-5/8"** center to center. Holley carbs without secondary metering plates may be run inline. **Dominator** carb plate is at **8-3/4"** center to center.

B-9050 Standard B-9053 Dom

Single four barrel carb adapter plate for 6.71 or 8.71 blower. Accepts **Standard** Holley and Carter four barrel carbs or **Dominator.**

B-9052 Standard B-9054 Dom



\$ 139ea

Includes: Billet Plate, Screen Gasket, Carb Base Gaskets, Cadmium Plated Bolts & Washers.

Stainless-Steel Carb Plumbing

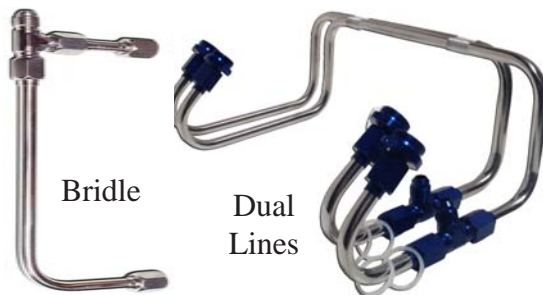

Bridle

Dual Lines

Premium Quality

3/8" seamless **Polished Stainless-Steel** tubing with anodized aluminum fittings (or SS) for two double pump carbs mounted sidesaddle. Includes carb fuel inlet to AN6 fittings and provides a AN6 Tee fuel connection per carb to supply fuel to both carb bowls.

Works on blowers and tunnel rams

4150 Dual Lines	4150/Demon Bridle
B-9201 Blue \$149	B-9221 Blue \$49
B-9202 Black \$149	B-9222 Black \$49
B-9200 SS \$229	B-9220 SS \$79

4500 Dual Lines	4500 Bridle
B-9207 Blue \$149	B-9227 Blue \$49
B-9208 Black \$149	B-9228 Black \$49
B-9206 SS \$249	B-9226 SS \$79

Demon Dual Lines

B-9204 Blue \$149
B-9205 Black \$149
B-9203 SS \$229



More pics & descriptions online.

Billet Alum Fuel Rail

Single Inlet to feed Dual Holleys.
 Single Return Back to Tank

Show
 Polished!



B-9256
\$98.99



FREE Catalog!

Engine Bearings

800/576-7661



Need more bearing info?



KING RACING High Performance Bearings

Proven effective on circle track engines running at 8000rpm, on Top Fuel Blown Engines producing 5500HP as well as on high performance street vehicles. Alecular material offers an extremely high temperature threshold and high load capacity.



Main Bearings

MB-557HP-STD	350 SBC STD 1/2 Groove	65.99
MB-557HP-001	350 SBC .001 1/2 Groove	65.99
MB-557HP-010	350 SBC .010 1/2 Groove	65.99
MB-557HP-011	350 SBC .011 1/2 Groove	65.99
MB-557HP-020	350 SBC .020 1/2 Groove	65.99
MB-557HP-STDX	350 SBC .001 Oversize 1/2 Grve	65.99
MB-509HP-STD	400 SBC STD Half Groove	61.99
MB-509HP-010	400 SBC .010 Half Groove	61.99
MB-509HP-020	400 SBC .020 Half Groove	61.99
MB-509HP-STDX	400 SBC .001 Oversize Half Grve	61.99
MB-5163HP-020	400 SBC .020 Full Groove	56.99
MB-5163HP-030	400 SBC .030 Full Groove	66.99
MB-556HP-STD	BBC STD 1/2 Groove	82.99
MB-556HP-001	BBC .001 1/2 Groove	82.99
MB-556HP-010	BBC .010 1/2 Groove	82.99
MB-556HP-011	BBC .011 1/2 Groove	82.99
MB-556HP-020	BBC .020 1/2 Groove	82.99
MB-556HP-030	BBC .030 1/2 Groove	82.99
MB-556HP-STDX	BBC .001 Oversize 1/2 Groove	82.99
MB-5164HP-STD	BBC STD Full Groove	94.99
MB-5116HP-STD	440/426 Hemi STD 1/2 Groove	78.99
MB-5116HP-010	440/426 Hemi .010 1/2 Groove	78.99
MB-5650HP-STD	BBF STD 1/2 Groove	69.99
MB-5503XP-STD	FORD 351C STD 1/2 Groove	81.99
MB-5503XP-010	FORD 351C .010 1/2 Groove	81.99

Rod Bearings

CR-807HPN-STD	350 SBC STD w/o Dowel	65.99
CR-807HPN-001	350 SBC .001 w/o Dowel	65.99
CR-807HPN-010	350 SBC .010 w/o Dowel	65.99
CR-807HPN-020	350 SBC .020 w/o Dowel	65.99
CR-807HPN-STDX	350 SBC .001 Oversize w/o Dowel	65.99
CR-803HPN-020	327 SBC .020 w/o Dowel	68.99
CR-807HPND-STD	350 SBC STD w/ Dowel	68.99
CR-807HPND-010	350 SBC .010 w/ Dowel	68.99
CR-807HPND-020	350 SBC .020 w/ Dowel	68.99
CR-807HPNDSTDX	350 SBC .001 Oversize w/ Dowel	68.99
CR-807HPND-010X	350 SBC .009 w/ Dowel	68.99
CR-807HPND-020X	350 SBC .019 w/ Dowel	68.99
CR-803HPND-STD	302 SBC STD w/ Dowel	66.99
CR-808HPN-STD	BBC STD w/o Dowel	82.99
CR-808HPN-001	BBC .001 w/o Dowel	82.99
CR-808HPN-010	BBC .010 w/o Dowel	82.99
CR-808HPN-020	BBC .020 w/o Dowel	82.99
CR-808HPN-STDX	BBC .001 Oversize w/o Dowel	82.99
CR-808HPND-STD	BBC STD w/ Dowel	84.99
CR-808HPND-001	BBC .001 w/ Dowel	84.99
CR-808HPND-010	BBC .010 w/ Dowel	84.99
CR-808HPND-011	BBC .011 w/ Dowel	84.99
CR-808HPND-020	BBC .020 w/ Dowel	84.99
CR-808HPND-STDX	BBC .001 Oversize w/ Dowel	84.99
CR-806HPND-STD	440/426 HEMI w/ Dowel	99.99
CR-806HPND-001	440/426 HEMI .001 w/ Dowel	99.99
CR-806HPND-010	440/426 HEMI .010 w/ Dowel	99.99
CR-874HPN-STD	BBF STD w/o Dowel	74.99

Why Use King Bearings?

- * Improved consistency of bearing-to-journal clearance, so you never have to worry about King bearings having the right fit within a set.
- * Superior eccentricity and crush relief values for a better oil "wedge" and less journal wear.
- * Decreased taper across the bearing face, yielding superior wall stability, a more parallel wall and better oil film development.
- * No need to grind cranks "fat" or "thin" to compensate for bearing wall variations.





Total Seal Gapless Piston Rings

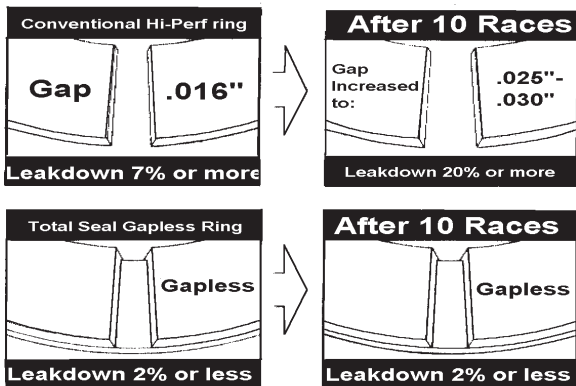

Keeps Leakdown to **2% or Less!**

As a normal ring wears, the gap opens up allowing combustion gasses to escape. The Total Seal Gapless ring has no gap. Instead, its patented design incorporates a 2-part interlocking ring to close the gap and provide a more perfect seal between the piston and cylinder.

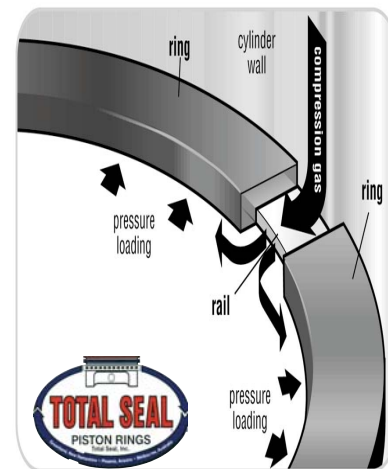

WHY Total Seal Piston Rings?

*Improved Consistency
Cleaner Engine Oil
Better Oil Control
Less Friction
Wilder Torque Curve
More Engine Vacuum
Less Blowby
Longer Engine Life*

*Increased Horsepower and Torque
Lower Engine Oil Temperatures
Saves Money (Fewer Teardowns)*

Not sure if Total Seal gapless rings are right for you? Compare the facts and then decide.



Gapless 2nd RACE Sets 1/16 1/16 3/16

4.035 TS-T3690.35	\$ 239
4.065 TS-T3690.65	\$ 239
4.155 TS-T0690.30	\$ 239
4.255 TS-T9190.05	\$ 244
4.285 TS-T9190.35	\$ 244
4.315 TS-T9190.65	\$ 244
4.355 TS-T6490.35	\$ 244
4.385 TS-T6490.65	\$ 244
4.445 TS-T9190.195	\$ 244
4.505 TS-T9190.255	\$ 244
4.567 TS-T9130.5	\$ 268
4.605 TS-T9150.5	\$ 268



.017 Dykes 1/16 3/16

4.255 TS-T1702 5	\$ 284
4.285 TS-T1702 35	\$ 284
4.315 TS-T1702 65	\$ 284
4.380 TS-T1702 130	\$ 284
4.505 TS-T1702 255	\$ 284

Call for Other Sizes

Leakdown Tester **\$119**
Dual Gauge
w/ 14mm Hose
Professional
Grade
T-2002

**Ring
Compressor**
Heat Treated
Anodized Alum
Fixed \$ 39 Adjustable \$49

**Assembly
Lube** TS-AS
8oz
\$ 18 ea

Quick Seat
TS-QS

Files rings simply, quickly and accurately. A must tool for the serious auto enthusiast.

Electric Ring Filer
\$699

T-2021 .. 110V T-2022 .. 220V

Ring Filer \$104
T-2020
Bench Mounted

I just wanted to thank you for your excellent service. Parts must of been dispatched within minutes of me ordering & arrived safe & sound today. Total time from ordering to delivery was just 3 days, excellent service considering I live in England. Once again, thanks & I look forward to the next time we do business. Cheers, Mark Sheridan, Middlesex, England



More
Online
Testimonials

Same Day, Low Cost
Fast Worldwide Shipping!

www.DragParts.com

Fabricated Valve Covers

Fabricated from 6061 alum and welded with billet rails. Designed for the hot rodder who demands a higher quality valve cover with extra room for valve train.

- ACC-2324 SB Chevy **\$ 139**
- ACC-2335 BB Chevy **\$ 169**
- ACC-2364 SB Ford **\$ 149**
- ACC-2384 BB Ford **\$ 149**
- ACC-2342 SB Mopar **\$ 123**
- ACC-2344 BB Mopar 440 **\$ 148**



SBC

With or
w/o Hole
BBC



**440
Mopar**



SBF



Cast

**POLISHED
ACC-2353 \$749**

**BLACK ANODIZED
ACC-2354 \$575**



Stage V Single-Plug
 High Quality Cast Aluminum
 Relieved for larger retainers
 Fits most *late model* aftermarket heads
 Use stock spark plug tubes
 Very popular with Top Fuel and Alcohol

426 Hemi

- * Polished or Black
- * Cast Aluminum
- * Use Stock Tubes **\$329**
- * Original Design
- * Machined for Breathers



ACC-2351

Fabricated



Fabricated from 6061 Alum
 and Welded with Billet Rails.
ACC-2356 \$ 299

Hemi Dual Plug Alum Block Offs



**ACC-2358
\$129.99**

For those running dual plug
 covers with single mag.
 Set of 8.

Valve Covers

- * Tall for Clearance
- * Quality Alum Casting
- * Show Polished
- * Recessed & Baffled
- * Hole for Breather

- ACC-2320 SB Chevy 283-350 **\$ 79.95**
- ACC-2330 BB Chevy 396-502 **\$ 99.95**
- ACC-2360 289-351W 5.0L Ford ... **\$ 84.95**
- ACC-2300 Wing Nut 1/4 -20 x 4in **\$ 2.50**

Valve Cover Gaskets

- Black rubber with solid steel core.
- G-2320 SBC **\$ 12.95/pr**
 - G-2325 BBC **\$ 14.95**
 - G-2330 SBF **\$ 13.95**
 - G-2335 351C **\$ 14.95**
 - G-2340 428 **\$ 16.95**
 - G-2345 BBF **\$ 16.95**
 - G-2305 Mopar **\$ 15.95**
 - G-2355 Olds **\$ 14.95**
 - G-2350 Pont **\$ 15.95**



SB Ford



SB Chevy



BB Chevy



Good Vibrations is proud to be the Title Sponsor of IHRA's **Top Sportsman** & **Top Dragster**, the Quickest & Fastest Sportsman classes.



Breathers
See Page 20



A Pitmat is an exclusive material that can be used on a variety of surfaces including gravel, dirt, grass, concrete and asphalt. Its primary purpose is to provide a clean, durable and comfortable surface to park and maintain your vehicle while at the track or at the shop, but can be used for many other applications.

- *Resistant to Oils
- *Easy to Clean
- *Grommets
- *Mold Resistant
- *Flame Resistant



All Sizes
in Stock

4 X 6 Mini	13 lbs ...	\$ 21
10 X 10	25 lbs ...	\$119
10 X 20	43 lbs ...	\$239

Most Popular Sizes

10 X 30	71 lbs ...	\$329
12 X 30	85 lbs ...	\$429
15 X 30	97 lbs ...	\$494
12 X 40	102 lbs ...	\$610
15 X 40	127 lbs ...	\$659

*** PreOwned Performance Parts ***

We pay CASH for good, used Race Parts!



Roots Blowers
Pulleys & Belts
Injection Hats
Fuel Pumps



Safety Equipment
Magneto Ignitions
Oil Pumps



Specialty Tools
AN Fittings & Hose
Zoomie Headers



Current Used
Parts Inventory
is Online







FREE Catalog!

www.DragParts.com

Steering Wheels & Boxes

Quality Steering Components for your Funny Car, Altered or Dragster.



\$93    Steering wheels are CNC machined. not stamped, from heat-treated aluminum. **Includes:** Switch tab and ergonomic grips.

- C-7250 B-Fly Steering Wheel w/ Tab \$ 58.99
- C-7250.D Above *pre-drilled* for QR hub \$ 62.99
- C-7255 B-Fly Steering Wheel w/ Tab & Grips \$ 92.99
- C-7255.D Above *pre-drilled* for QR hub \$ 97.99
- C-7261 B-Fly Steering Wheel Grips -Red \$ 58.99
- C-7262 B-Fly Steering Wheel Grips -Blue \$ 58.99

Ideal for Front Engine applications:

Altered, Roadsters and FCs. CNC machined, zero backlash. C-7222



C-7225

CNC machined from alum & hi-strength steel. **Ideal for Dragsters.**

Weights less than 2lbs!
11" eye-to-eye.



\$250

- C-7115 Steering Box Dragster \$ 249.99
- C-7222 Steering Box Funny Car Std \$ 592.99
- C-7225 Pitman Arm \$ 47.99



- C-7292 3 Bolt Q.R Steering Hub 1/4" SFI \$ 74.99
- C-7292 4 Bolt Q.R Steering Hub SFI \$ 74.99
- C-7296 Splined Coupler 5/8-36 \$ 23.99
- W-270-2017 Q.R. Steering Hub 5/8 \$ 25.99
- W-300-2020 Steering hub shaft 5/8 \$ 9.99
- PW-C42-512 Brake Lever 18in w/ Pol Grip \$ 83.99

PS Anglia-Style Spindle Kits

CNC machined and double-lock on steering arm to ensure against movement.

Billet Chromoly Forging 2" King pin bosses

*Dragsters
Altered
Funny Cars*



\$350/ Set

Complete with:

Pins, 2 5" Arms, Alum Caps & ARP Hardware.

- C-7120 Chromoly Spindle Set \$349.99
- C-7105 Steering Arm Billet Steel 5" \$ 28.99
- C-7106 Steering Arm Billet Steel 6" \$ 28.99
- C-7109 Steering Arm Steel 5" \$ 16.75
- C-7122 Tow Caps (pr) \$ 27.99

FC/Altered Front Brake Kits

Includes Mounting Hardware!



Designed for the PS/Anglia style spindle popular on Funny Cars and Altered.

Wilwood Master Cylinders are high pressure die-cast from aerospace quality aluminum & fully machined.



- W-260-4894 Master Cylinder Dual \$ 115.99
- W-260-6764 Master Cylinder 3/4" \$ 54.99
- W-260-6765 Master Cylinder 7/8" \$ 54.99
- W-260-6766 Master Cylinder 1" \$ 54.99
- W-260-1874 Residual Valve 2psi \$ 17.99
- W-120-2498 Front Caliper Dynalite \$ 100.99
- W-120-6818 Rear Caliper Dynalite \$ 121.99
- W-150-1251K Front Pads Round Spot .. \$ 30.99
- W-150-9764K Front Pads Square \$ 38.99
- W-150-8850K Rear Pads \$ 39.99
- W-140-3326 FC/Altered Front Brake Kit \$ 623.99



Tabs & Brackets
QTY Discounts!

800/576-7661

Premium Chassis Tabs



Over 99 %
of all race
parts sold
by Good
Vibrations
Motorsports
are proudly
made in the
USA with
superior
material &
excellent
quality
control.

Carbon Steel 1/8 Thick

- a. C-8152 Double Sided 3/8 hole \$ 4.99
C-8152.5 5 Pack \$21.99
- b. C-8150L Single Sided LH \$ 4.99
C-8150L.5 5 Pack \$21.99
- c. C-8150R Single Sided RH \$ 4.99
C-8150R.5 5 Pack \$21.99
- d. C-8154 Universal 3/8 hole \$ 1.99
C-8154.5 5 Pack \$ 8.99

Chromoly 1/8 Thick

- a. C-8186 Double Sided 3/8 hole \$ 7.99
C-8186.5 5 Pack \$38.99
- e. C-8184 Universal 3/8 hole \$ 6.99
C-8184.5 5 Pack \$33.99
- f. C-8182 Universal 3/8 hole \$ 5.99
C-8182.5 5 Pack \$28.99

Hi-Quality Rod Ends

Male & Female
Left & Right Hand



Female Right Hand

- CREF-3-3 10-32 \$6.99
- CREF-4-4 1/4-28 \$6.99
- CREF-5-5 5/16-24 \$7.99
- CREF-6-6 3/8-24 \$7.99
- CREF-7-7 7/16-20 \$8.99
- CREF-8-8 1/2-20 \$9.99

Male Right Hand

- CREM-3-3 10-32 \$6.99
- CREM-4-4 1/4-28 \$6.99
- CREM-5-5 5/16-24 \$7.99
- CREM-6-6 3/8-24 \$7.99
- CREM-7-7 7/16-20 \$8.99
- CREM-8-8 1/2-20 \$10.99

Female Left Hand

- CREF-3L-3 10-32 \$7.99
- CREF-4L-4 1/4-28 \$6.99
- CREF-5L-5 5/16-24 \$7.99
- CREF-6L-6 3/8-24 \$7.99
- CREF-7L-7 7/16-20 Call
- CREF-8L-8 1/2-20 Call

Male Left Hand

- CREM-3L-3 10-32 \$6.99
- CREM-4L-4 1/4-28 \$6.99
- CREM-5L-5 5/16-24 \$7.99
- CREM-6L-6 3/8-24 \$7.99
- CREM-7L-7 7/16-20 \$9.99
- CREM-8L-8 1/2-20 \$10.99

Don't trust your Race Car to inferior brands

Premium DZUS Fasteners



Installation
Video

- a C-83010 Steel .550 Button \$ 1.55
10 Pack \$14.95
- b C-83013 Steel Backing Plate \$.65
10 Pack \$ 5.95
- c C-83015 Steel Spring \$ 1.19
10 Pack \$10.95
- d C-83017 Doubler Round \$.85
10 Pack \$ 7.95
- e C-83018 Doubler Square \$.85
10 Pack \$ 7.95

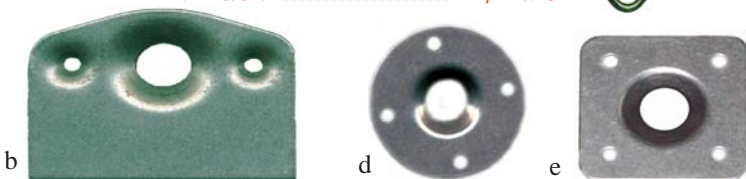

- f C-83020 SE Button Assy \$ 2.95
10 Pack \$28.95
- g C-83023 SE Backing Plate \$.65
10 Pack \$ 5.95
- h C-83025 SE Steel Spring \$ 1.19
10 Pack \$10.95



Self
Ejecting
DZUS
(SE)



Dimpling Tool

Professional way to
dimple your sheet
metal for DZUS.

C-83005 \$27.99



C-83007
DZUS
Wrench

Engine Floating Saddle Mount

- * Tig Welded Chromoly
- * Fits 1-1/2in Tubing

Dragsters, Altered
Funny Cars

- C-8190 Floating Saddle Mount \$ 30.99
- C-8198 SS Band Clamp 1.5 - 1.875 \$ 7.99



Same Day, Low Cost
Fast Worldwide Shipping!

www.DragParts.com

Hi-Torque Starters

Ideal for High Comp and Supercharged Engines



View Complete Selection Online!

4.40 to 1 Gear Reduction
 534 ft./lbs. Torque!
 Lightweight (8.8lbs)
 Compact and Adjustable
 Heat-Resistant Solenoid
(No Hot Start Problems)

US Patented



Chevy



Ford



Pontiac/Olds



Diesel
 12 & 24V



VW Porsche



Mopar

Guaranteed with a Warranty !

Up to 4.5KW!

CHEVY

- IMI-102 Chevy 1.3hp \$ 179
- IMI-102N Chevy 1.9hp \$ 219
- IMI-902 Chevy 2.0kw \$ 298
- IMI-22103 Chevy 2.2kw \$ 449
- IMI-935 Chevy 2.0kw Offset \$ 298
- IMI-301-003 Chevy Marine \$ 219

PONTIAC/ OLDS

- IMI-108 Pont/Olds 1.3hp \$ 189
- IMI-108N Pont/Olds 1.9hp \$ 219
- IMI-908 Pont/KB Olds 2.0kw \$ 349
- IMI-141R KB Olds 1.4kw \$ 229

FORD

- IMI-106 Ford 1.3hp Auto \$ 189
- IMI-107 Ford 1.3hp Manual \$ 179
- IMI-906 Ford 2.0kw Auto \$ 329

MOPAR

- IMI-109 Mopar 1.3hp \$ 189
- IMI-909 Mopar 2.0kw \$ 349

VW/ PORSCHE

- IMI-101 VW-Porsche 1.3hp \$ 199
- IMI-101N VW-Prsche 1.9hp \$ 229
- IMI-104 VW Vanagon 1.9hp \$ 229
- IMI-105 VW 6 Volt Flywheel \$ 198

Diesel

- IMI-25002-002R Farmhall \$ 399

Blower Starter & Parts



Simply the Best !



Lightweight & Removable
 36-48-60 Volts



48 Volts
 Battery Pack
 B-5053



Copper!



- RCD-100500-0011 Blower Starter \$ Call
- B-5053 48 Volts Battery Pack w/ Charger .. \$ 898
- B-5052 Battery Charger for above \$ 149
- B-5060 Premium Copper Battery Cables 15ft \$ 139
- RCD-102505-18 Heavy Duty Relay \$ 118
- B-5046 Anti-Tipover Foot Alum \$ 45
- B-5047 Quick-Disconnect Battery End \$ 19
- PW-C72-029 Pull Handle \$ 14
- B-5048 Premium Momentary Toggle Switch \$ 14
- RCD-101520-17 Starter Brush. New style \$ 8



Professional Products at Sportsman Prices!



Parachutes

Chutes-Fire System

800/576-7661



Too Fast? We Can Stop You! Drag Chutes

- DJ-851252 Super Quad (et, sg, sc, ts, td) .. \$ 291
- DJ-851067 Doorslammers up to 2500# \$ 435
- DJ-851070 Pro Mod & Blown Alcohol \$ 486
- DJ-851070.2 Above with Launcher \$ 809
- DJ-851079 Top Fuel Dragster/ FC \$ 526
- DJ-851424 BOAT: Blown Gas or Alcohol \$ 535
- D-30470 Nylon Pack 7x7 \$ 60
- DJ-852999 Nylon Pack 9x9 \$ 87
- DJ-852996 Silver Pack 9x9 \$ 125
- DJ-852809 Pilot Chute Heavy Duty \$ 87
- DJ-852200 Release Cable with Lever \$ 51
- DJ-911341 "Remove Before Run" Flag \$ 7



Over a Dozen styles to choose from !!

Black * Red * Blue



Chutes Include: Quad Cross-Form Canopy, Pack, Pilot and Bridle Line.

Coldfire 302 Fire Systems

Coldfire302 is a harmless plant & water based fire suppressing agent. Is especially effective in Class B fires (Oil/fuel). Also suitable for wood & paper fires. Coldfire Suppresses quickly, prevents reflash, safe to store and leaves virtually no residue. Biodegradable and environmentally safe.

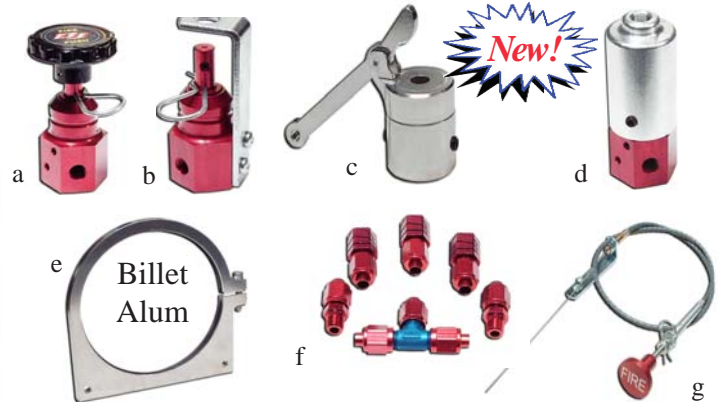

More Cables on Pg 15

- a. DJ-911327 Manual Injector \$ 99
- b. DJ-911328 Mnl Injector & Brckt \$ 107
- c. DJ-911329-2 Pull-Style Adapter \$ 79
- d. DJ-911329 Pneumatic Injector \$ 191
- e. C-8420 Mounting Bracket 5.25 \$ 33
- f. DJ-911311 Nozzle & Fitting Kit \$ 94
- DJ-911101 10lb Bottle Only \$ 374
- DJ-911312 10' Alum Tubing 1/4" \$ 23
- g. CC-86U04 Remote Cable from 3ft \$ 55

We have Complete Systems for Most Classes & Applications.



Systems & Parts Online

On-Board Systems

Accepted by Most Sanctioning Bodies

- DJ-911050 5lb Sys \$ 489
- DJ-911100 10lb Sys \$ 523
- DJ-911100.FC 20lb \$1146

DOT & SFI Approved

Bottles Can be Recertified & Refilled



Photo By: Sheryl Ogonoski



FREE Catalog!

www.DragParts.com

Seat Belts and Harnesses

Seat Belts Out-of-Date?

DJ Safety offers over 100 combinations of 5pt Seat Harnesses.
Options Include: Latch/ Link design or Quick-Release (CamLock)
2" or 3" wide. **3 Styles of Attachment:** Wrap-around, Bolt-in or Snap-in.

5pt Latch/Link style ... most	\$ 108
w/ Fire Protective Covering	\$ 148
5pt Cam Lock style	\$ 195
w/ Fire Protective Covering	\$ 242
Rewebb & Recert most	\$ 85
w/ Fire Protective Covering	\$ 131



Cam
\$195



View Online Selection



Latch
\$108



Cam Lock



Latch/Link

Buckle Styles

SFI 16.1
Fresh Dates!
Also Available
in 6 & 7pt



Colors:
Black
Red
Blue

Belt Mounting Options

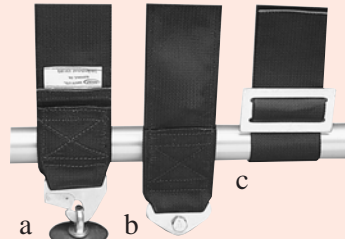

- a. Snap-In
- b. Bolt-In
- c. Wrap-Around

Shoulder Pads

- D-70200 2" Slip-On Pads Nomex .. **\$ 31**
- DJ-603050 3" Fire Retardant Pads **\$ 33**

Sold in Pairs



Shoulder pads are available as Slip-Ons or Sewn-In.
Great Driver Comfort.

Premium Seatbelt Hardware

Hardware is made of high quality steel for that extra measure of safety you are looking for and deserve.

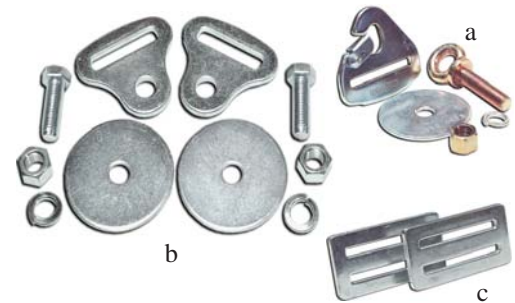

- a. DJ-600105 Snap-In Kit w/ Hardware **\$10**
- b. DJ-600305 Floor Mount Kit w/Hrdwr (pr) **\$ 9**
- c. DJ-600402 3-Bar Adjuster 2" (pr) **\$ 5**
- c. DJ-600403 3-Bar Adjuster 3" (pr) **\$ 8**

Window & Wheelie Bar Nets

- DJ-221721 Angular 17x21 **\$ 57**
- DJ-221824 Square 18x24 **\$ 45**
- JAZ-906-03 Installation Kit **\$ 64**
- DJ-220001 Wheelie Bar **\$ 54**

Dual Wheels or Single Tripod Wheelie Bars

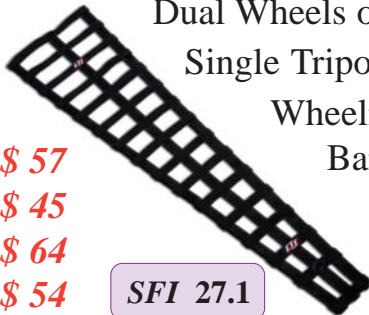

SFI 27.1



Arm Restraints



SFI 3.3

Arm Restraints have a velcro closure and are adjustable in length.

DJ-605009 Arm Restraints **\$ 36/pr**



Professional Products at Sportsman Prices!



Discounted Safety Equipment!

Blow Restraint/ Diaper



800/576-7661

Blower Restraints



Billet 7075-T6 Aluminum
Silver Aluminized Straps
Quick-Disconnect Pins

Re-certifiable

- DJ-141000 Restraint w/ Hardware SFI 14.1 **\$ 399**
- Restraint Only, No Hardware SFI 14.1 **\$ 299**
- DJ-141999 Re-Certification SFI 14.1 **\$ 114**
- DJ-141002 Adjustable Silver Straps (4ea) .. **\$ 127**
- DJ-141900 Mounting Hardware w/ pins **\$ 149**
- DJ-142007 Top Alcohol Restraint with Kevlar Ballistic Bag and Steel Hardware. SFI 14.2 **\$1287**
- DJ-143103 Top Fuel Restraint with Kevlar Ballistic Bag and Steel Hardware. SFI 14.3 **\$1789**

Need Premium Gaskets? See Page 21



Blower Bags

Non-SFI **\$ 299**
SFI 14.2 **\$ 369**

Ideal for those wanting extra protection around the blower.

B-7306 6.71 B-7308 8.71 B-7314 14.71

Trans Blankets

Multiple layers of Ballistic material to capture exploding shrapnel.



Perfect Fit
Water - Oil Resistant
Dozens in Stock
Custom Available
Re-certifiable !

Heavy-Duty Race Car Tiedowns

Webbing is 1.75" wide. Burst Strength: 5,000lbs
Snap-in J-Hook Ends. American Made!

- a. DJ-236201.12 Inline Ratchet Tiedown **\$ 31.99**
- b. DJ-236205.8 w/ Sewn-In Axle Loop **\$ 31.99**
- c. DJ-238044 Flush Mounted D-Ring **\$ 9.99**
- d. DJ-237224 Heavy-Duty Axle Strap 24" **\$ 11.99**
- DJ-241202 Heavy Duty Tow Strap 14' **\$ 31.99**

Sportsman Engine Diapers

SFI 7.2

Snap-in Absorbant Pads.
Q.D. Adjustable Straps.
Tailored Fit. Ballistic Nylon.

- DJ-730281 SB Ford
- DJ-730350 SB Chevy
- DJ-730454 BB Chevy
- DJ-730426 426 Hemi



\$238

Most Other Makes in Stock!

Pro Engine Diapers

Adjustable quick-release buckles attaches to the header flanges.
Reusable Snap-in Absorbant Pads.
Wet & Dry Sump. Can be recertified.



TF/TA
Legal

SFI 7.1

- DJ-711001.bal Soft Ballistic Nylon **\$ 713**
- DJ-711002 Soft Kevlar (shown) ... **\$ 980**
- DJ-710002 Carbon Fiber Bucket ... **\$1073**
- DJ-710401 Replacement Pads (pr) **\$ 77**

Plug Wire Shield

Protect spark plug wires in the event of a burst panel or blower back-fire.



DJ-070200 ... **\$ 24.99**

- DJ-801012 Powerglide **\$ 185**
- DJ-801014 Turbo 350/400 **\$ 229**
- DJ-801126 Lenco Reverser (only) **\$ 137**
- DJ-801124 Lenco 2spd w/Rev **\$ 208**
- DJ-801152 Lenco 3spd w/Rev **\$ 239**
- DJ-801181 B&J 3spd w/Rev **\$ 239**

Most other Makes in STOCK!



Online Tiedowns



Don't trust your race car to inferior brands !

Same Day, Low Cost
 Fast Worldwide Shipping!

www.DragParts.com

Nomex Driving Suits

Suits are manufactured to meet one of the following specs:

SFI 3.2A/1, 5 or 20.

Standard Suits are one solid color with contrasting trim.

Sizes: S-XXL

Colors: Black Red Blue

DJ Safety sfi /20 suits can be recertified every 5 years!

Choose from 1pc or Separate Jacket and Pants



Complete Selection Online

Options:

- Arm Restraints
- Kool Pad Pockets
- Embroidery



SFI 1 Suits (1 Layer)

- DJ-011200 Jacket .. \$ 99
- DJ-011300 Pants \$ 99
- DJ-011100 1pc Suit . \$174

SFI 5 Suits (2 Layer)

- DJ-012200 Jacket ... \$ 228
- DJ-012300 Pants \$ 218
- DJ-012100 1pc Suit \$ 439

SFI 20 Suits (4 Layer)

- DJ-014200 Jacket ... \$ 789
- DJ-014300 Pants \$ 616
- Sewn-in Restraints \$ 69

Driving Boots



DJ styling Driving Shoes feature padded Kevlar lining and velcro closure.



Sizes: 6-13 in Full Sizes **Colors:** Black Red Blue Gray

DJ-050000 sfi 3.3/5 Shoes \$ 98

DJ-051000 Alky/TF sfi 3.3/20 Boots \$ 252

Kool Vest

Keeps driver or crew member comfortable for upwards of an hour. Thin vest easily fits under driver's suit. Has one pad on upper back and one on each kidney.



Sizes: S-XXL

D-03520 ... \$ 75

D-03520-3 Extra/Replacement Kool Pads \$10.99 ea

Driving Gloves

Leather Palm Gloves offer excellent protection while maintaining a high level of comfort.



DJ-022000 Nomex sfi 3.3/5 \$ 57

DJ-024100 Nomex sfi 3.3/20 \$ 175

Colors
 Black
 Red
 Blue



How to Measure Glove Size

Lay hand flat with fingers and thumb together. Measure circumference at widest point.
 9" =Sml, 10" =Med, 11" =Lrg, 12" =XL

Roll Bar Padding

SFI 45.1
 Black Red Blue
\$22.95



3' Length

Rollbar padding is made of high-density foam. Fits 1-1/2" to 1-3/4" diameter tubing. 3/4" thickness.

Helmet Bar Padding (1 - 1.25") \$17.99

Foam Padding

3' Length
 Black
 Silver
 Red
 Orange
 Yellow
 Blue



\$7.99

We stock jr Dragster Equipment !!





View Racing
Helmets Online



800/576-7661

Race Helmets

Helmets are built to meet and exceed **Snell 2015 SA** rating has a fire-resistant liner.



Full Face

Sizes: XS-XXL

SA2015 **\$ 344**



SA2010 Full Face

Helmets \$190 - \$230

Limited Sizes Left



Note: Blown Alcohol & Nitro applications usually requires a Snell "SA" rating.

How to Measure Helmet Size



Video



Hat Size Circumference

XS	6 1/2"	21 5/8"
S	7"	22"
S	7 1/8"	22 3/8"
M	7 1/4"	22 3/4"
M	7 3/8"	23 1/8"
L	7 1/2"	23 1/2"
XL	7 5/8" ...	24"
XXL	8"	25"

To properly determine head circumference, run a soft tape measure around your head (approximately one inch above your eyebrows and just over the ears).

Head & Neck Restraint

NecksGen Head and Neck Restraint System features an innovative tether design that distributes impact loads through 4 different load paths. With an adjustable rear brace designed to fit seat angles from 10-40 degrees.

Adjustment range also allows for a custom fit to the driver. Free floating pads allow for maximum comfort, while the US-made Dupont carbon-composite material offers strength and weight savings.

Equipment Bags



Made from a high quality rip-stop nylon. Internal padding. 3 pockets.



Helmet Bag

DJ-036010 **\$29.99**

Gear Bag

DJ-070410 **\$47.99**

Aircraft Legal Carry On Size !



Helmet Supports

Velcro Closure

SFI Approved **\$ 33.99**

DJ-040009

Tapered For Comfortable Fit



Head Socks/ Underwear

Head Socks are designed to be worn under the helmet. These soft nomex knit hoods provide an extra measure of protection. Nomex underwear are also soft and gives a driver a few extra critical seconds of time.



Black or White

D-03211 1 Layer Sock ... **\$ 45.99**

DJ-062002 2 Layer, *sfi 3.3* **\$ 53.99**

DJ-060000 Top S-XL **\$ 77.99**

DJ-061000 Pants S-XL **\$ 77.99**

DJ-063040 Socks **\$ 25.99**



Nostalgia Mask



Made of Aluminized Silver.
Includes Breathers.

D-83110-SIL Mask non-SFI **\$ 462**



SFI 38.1



DJ-606803 Medium DJ-606807 Large **\$ 588**



FREE Catalog!



You just found those Hard-To-Find Tools !!



\$169

Cam Degree Installation

Makes degreering a cam a lot quicker and easier. This fixture attached to the block over cylinder #1 using two of the block studs (or bolts). An adjustable stop is included for helping determining top-dead center. Simply install a dial indicator into either the intake or exhaust hole of the fixture.

T-1117 HEMI T-1115 SBC
T-1119 392 T-1116 BBC

Valve Lash Adjuster

Quickly and accurately adjust your valves with this custom tool. Machined from stainless-steel for durability with choice of 7/16, 1/2 or 9/16 hex.

Fits SBC, BB, Mopar & Fords.
1/8 7/32 3/16 hardened Tip.



\$59.99

Stainless Steel

T-1125 7/16 Hex. T-1126 1/2 Hex. T-1128 9/16 Hex.

Main Cap Puller

The bottom-end guy sure appreciates this main cap slide puller. The 5/16 heat-treated threads are easily threaded into the main cap using the slip-proof knurled knob. A simple tug of the tool allows the cap & lower bearing to drop safely into your hand. A great asset for between round thrashes. Also great to have one at the shop.



T-1103 2.5 lbs \$68.99

T-1100 4.5 lbs \$99.99

Wrist Pin Checker

A piston pin failure is catastrophic. Period. And checking their roundness was always a challenge. Now there is a cool tool that allows you to check the pin's roundness to less than .001 thousands in less 5 seconds. And that all adds up to NO kaboom.



T-1132 \$136

Push Rod Straightness Checker



\$139.99

Valve train failure is normally catastrophic and a bent push rod can be attributed as a culprit in many instances. A pushrod out-of-round as little as .010 will begin to flex. I'm sure you have seen the wear marks on the sides of your pushrods and wonder how they got there. With the Pushrod Checker, simply insert the pushrod into the spring-loaded end, rotate 360 degrees and quickly check the roundness of a pushrod to less than .001.

T-1120 BBC
T-1121 Fathead
T-1122 Hemi Fuel

Rod Bolt Stretch Checker

One simply inserts the rod bolt into the Bolt Stretch Checker and records the reading on the gauge. Bolts that are stretched more than .007 are usually discarded. A complete set of 16 bolts can be checked in less than 60 seconds. Might just be the best minute you invested in your engine assembly.



.0005 Accuracy!

T-1158 \$89

Rod-Piston Pusher

Here is a tool that allows one to safely and quickly install or remove the rod-piston combo out of the block. The pointed end of The Pusher is simply inserted into one of the two threaded holes in the connecting rod. The bend in the shaft allows easy navigation around the crankshaft journal. The diver with hot oil dripping onto his face will thank you profusely.

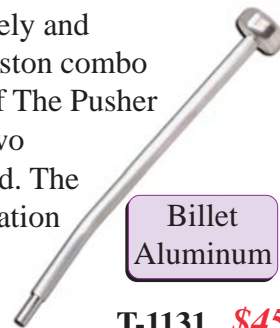

Billet Aluminum

T-1131 \$45

Hemi Top Dead Center Checker

Wanna' check your top dead center like a pro? Then grab one of these. Simply thread the checker into Cylinder #1 of your Hemi and rotate the crank until the dial indicator maxes out. A real time saver when trying to dial in a magneto or camshaft at the track.



T-1134

\$159.99



Billet Primer Bottle Top \$29.99

Machined from BILLET Alum and precisely drilled to allow correct flow of fluid during priming of a blown alcohol or nitro engine. Fits most plastic bottles. A Must Have!



T-1005

Sizes

4.187 - 4.500

\$216.99



New!

Puck Only **\$113**

Sleeve Puller

Sleeve puller is designed to quickly remove steel cylinder sleeves out of the engine block. Large loop handle grip protects one's hand from getting pinched by the slip-proof slide hammer. Puck can be replaced. Very popular with top fuel and alcohol teams.

Sleeve Installer

Sleeve installer is a quick and efficient way to install steel cylinder sleeves into the engine block. One size fits most sleeves. Very durable and rugged. Popular with top fuel and alcohol teams.



T-1098

\$68.99

Chevy Oil Pump Primer



T-2030 **\$20.99**

Engine Oil Pump Primer with sleeve. Inserts into distributor hole to prime the engine with oil prior to initial startup. Fits most V8 GM engines

Valve Spring Compressor

Valve Spring Compressor is one of the strongest on the market and is machined from 6061 BILLET Aluminum. This Spring Tool is designed to handle All-Out Racing Springs with more than 400lbs of seat pressure. This Spring Compressor kit comes with 3 different spring cups that accommodate a range from 1.250in up to 1.675in diameter.



T-1140 **\$294**

Billet Aluminum Wrench Sets



T-1160 Single End AN3-12 ~~\$106~~ **\$ 69.99**

T-1180 Double End AN3-20 ~~\$192~~ **\$119.99**

Need Just One? Single Wrenches Available

Adjustable AN Wrench

Protect the anodize on your AN Hose Ends. Knurl Thumbscrew. Minimizes chance of over-tightening.

Fits AN3-20



T-1150 AN3-8 **\$39**

T-1152 AN3-20 **\$44**

The newest member of the family is the mini. Great to have in your back pocket when you're on the starting line or if you need to get in tight spaces.

T-1154 **\$35**



Fits AN3-8

Valve Spring Pressure Tester

\$289 Allows one to check the valve spring pressure up to 500lbs while installed on the head. machined from BILLET aluminum for strength and anodized for ease of maintenance



T-1170 BAE FAT
T-1172 Miner Bros

Heat Sleeves

Features 100% heat-resistant woven Kevlar fabric, extra long sleeve protects arm above the elbow, oil and fuel resistant, snug fit allows comfortable fit.



MG-05-902 **\$23**

Same Day, Low Cost
Fast Worldwide Shipping!

www.DragParts.com

Spark Plug T-Wrench

\$59



T-1004

Spark plug T-handle wrench is machined from steel for strength and durability. Has a 13/16 socket with an internal rubber boot for holding spark plugs in place during assembly & removal. Very popular among sportsmen teams.

Torque Spark Plug T-Wrench

T-1003

\$149



Save time and head damage. This torque wrench only allows the spark plug to tighten to a pre-determined safe setting. Fits 13/16 plugs. Machined from steel for strength and Powder Coated. Very popular among Top Fuel & Alky.

“The Plug Gapper”

Quickly, precisely and accurately gap spark plugs. Billet Alum.



T-1002 \$59

Spark Plug Storage Rack

Heavy-Duty, yet lightweight rack is designed to store 8 spark plugs safely and in order. Large flat anodized bottom keep the rack upright and easily cleans up. Can be used stand-alone or bolted to a work bench. Those that assemble the engine top end will truly appreciate this rack regardless if they're at the shop or in the pits.



T-1136 Holds 8 \$40

T-1138 Holds 16 \$46

Valve Cover Speed Wrench

New!



T-Handle Valve Cover Speed Wrench is machined from lightweight steel (or polished Stainless-Steel) with a steel 7/16 socket. Conveniently helps to tighten or loosen valve cover nuts. Ideal for the racer looking to save time between rounds.

T-1008 Reg Steel \$49 **T-1006 Pol Stainless Steel \$59**

Lower Crank Gear Installer



T-1113 \$48

This tool allows one to safely install the crank gear onto the crankshaft. Has a knurl grip to prevent slippage and is heat-treated for durability. Will fit BBC, Hemi and other similar cranks.

Dampner Installation Kit



\$69

T-1110

Dampner kit for installation and removal of harmonic balancers and crank hubs. High quality kit fits most domestic applications. Comes complete in a hard shell case.

Crank Hub & Gear Remover



T-1112 \$157

This tool allows one to safely remove the blower crank hub or harmonic balancer. Unlike some lightweight models, the remover is heat-treated and built tough. It also has a provision for removing the crank gear. Proven many times over by Top Fuel teams.

Mag Timing Adjustment Wrench



MSD Magnetos

T-1015 \$155

Owners of MSD magnetos really appreciate this unique tool. The billet aluminum band remains clamped to the mag. The removable handle wrench allows for accurate adjustments of the mag while the engine is running. Very popular with Top Alcohol teams.

Magneto Drive Remover



T-1017 \$24

Designed to very quickly and safely remove the drive from a Mallory or MSD Magneto/ Distributor. It simply slips over and holds the 4-Pin or Hex Cross Drive so that one can remove the inner nut. No need to remove the magneto cap and hold the rotor. Ditto for installing the drive.



Injector Hat Tool Tray

Injector Hat Tool Tray is made from high grade aluminum and black powder coated for an attractive long-lasting finish. The tray has plenty of space for tools & also accommodates 16 spark plugs. Fits on top of Bug, Bird & Buzzard.



T-3020 \$129

Rack 'em Up !

Piston & Rod

Safely hold and protect 8 Pistons & Rods during assembly. A must for the serious racer. **T-3003**



\$157

Head Repair

Here's a great rack to store your Valves, Lash Caps, Shims & Retainers during head repairs. Billet anodized aluminum bottom tray. **T-3009**



\$144

Valve Train Trays

These trays are made of a very light-weight yet rigid plastic material with built-in handles. The valve tray holds valve springs, valve locks, and the largest of valves. The rocker tray holds push rods, lifters, poly locks, spark plugs and rocker arms. Perfect for the home mechanic or pro racer.



JAZ-735-001-06 Valve & Spring
JAZ-735-002-06 Rocker Arm & Lifter

\$34

Lifter/ Push Rod

Just set this tray in your lifter valley and store your pushrods & lifters in order. **T-3013**



\$113

Clutch Loading

Rack is heavyduty yet light-weight. Holds discs and rotors. Designed by a racer for racers.



T-3004 3 Discs ... \$ 99
T-3005 5 Discs ... \$111

Leakdown Tester

Dual Premiums Gauges
Billet Aluminum Housing
Ideal for: **Fuel Injection**
or **Engine Cylinders** **T-2003**



\$119

R U QUICK ENOUGH? Good Vibrations sponsors the Quick Reaction Time bonus for the following Series!

Check out
their Race
Schedules



**Vintage 7.60
Association**



**Nor Cal
Top Comp**



Same Day, Low Cost
 Fast Worldwide Shipping!

www.DragParts.com

Why Use CPE Braided SS Hose ??



Proven & Trusted by Top Teams, Stainless Steel Braid provides Durability and Heat Resistance. Inner liner is composed of Chlorinated Polyethylene (CPE) which provides the great fluid transfer with a temperature range of -40 degrees to +300 degrees F.

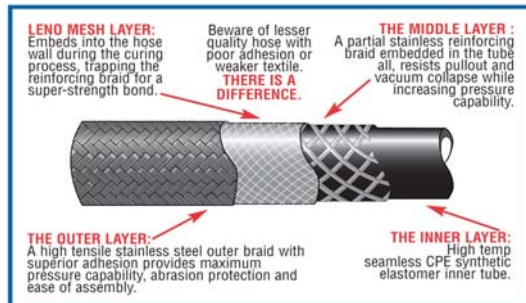

Discount Prices!

- AN-4 \$ 7.18/ft
- AN-6 \$ 6.90
- AN-8 \$ 8.90
- AN-10 \$ 9.90
- AN-12 \$ 10.90
- AN-16 \$ 13.90
- AN-20 \$ 17.90



NHRA/ IHRA Accepted

Want **BLACK** Hose?



Uses the same Hose Ends as the Braided SS Hose

XR-31 for the same price as Braided SS hose!

XR-31 Hose is tough, yet lightweight, durable, abrasion-resistant and economical. 3-Ply construction. High tube strength allows a tight bend radius capable for tight engine compartments.

Purosil Hose

Purosil Preformed Hose is very popular on Top Alcohol Fuel Systems.



90 Deg Bend (Fuel, etc..)

- X-390125 1.25 ID \$ 49.40
- X-390150 1.50 ID \$ 52.57
- X-390175 1.75 ID \$ 55.79

3ft Straight (Coolant)

- X-370125 1.25 ID \$ 61.20
- X-370175 1.75 ID \$ 76.02

Fyre Jacket



Silver Silicone-Coated Glass can withstand temps up to 500 deg F. Easy Installation.

AN4 - AN12 from.. \$ 5.81/ft

Braided Stainless Steel TEFLON Hose



Braided Stainless Steel TEFLON Hose and Reusable Hose Ends are used in Brake, Clutch, Instruments and other applications where max high pressure protection is a must.

- AN-3 X-610003... \$ 3.62/ft
- AN-4 X-610004... \$ 4.34/ft

TEFLON Hose Ends



- | | | | |
|------------|------|-------------|----------|
| <i>Str</i> | AN-3 | X-600003 .. | \$ 7.05 |
| | AN-4 | X-600004 .. | \$ 6.62 |
| <i>45</i> | AN-3 | X-604503 .. | \$ 10.95 |
| | AN-4 | X-604504 .. | \$ 10.95 |
| <i>90</i> | AN-3 | X-609003 .. | \$ 10.95 |
| | AN-4 | X-609004 .. | \$ 10.95 |

TEFLON Hose Assembly



We stock Pre-Assembled AN3 & AN4 Braided SS Teflon Hose Assemblies. Straights or 90 Deg Ends.

Lengths: 9" - 50" from.. \$9.77



Extensive Online
Fitting Selection



800/576-7661

Stainless-Steel Tubing

Great for plumbing your
Brake, Fuel or Fire System.

- E-ST18 3/16 \$6/ft
- E-ST25 1/4 \$7/ft
- E-ST37 3/8 \$7/ft
- E-ST50 1/2 \$8/ft



Seamless!!



BLACK or BLUE

Works on Steel or Alum Hard Line.

AN-3	X-981803....	\$ 1.05	X-981903....	\$ 1.05
AN-4	X-981804....	\$ 1.05	X-981904....	\$ 1.05
AN-6	X-981806....	\$ 1.35	X-981906....	\$ 1.37
AN-8	X-981808....	\$ 1.96	X-981908....	\$ 1.52
AN-10	X-981810....	\$ 2.77	X-981910....	\$ 2.31
AN-12	X-981812....	\$ 3.71	X-981912....	\$ 3.76
AN-16	X-981816....	\$ 5.33	X-981916....	\$ 3.81

Flaring Tool

Also
Deburs!

Roll-Flair flaring tool is
designed specifically for
hard-line tubing. Flares
37 degrees (true AN).
Fits 1/8 to 3/4"



\$113

X-821050



Surseat Line Lapper

Removes irregularities
37 & 45 Degrees

\$147 KT-P51



Surseat Mini Lapper

Gets into Tight Spaces
37 & 45 Degrees

KT-P37 KT-P45 \$59ea.

Most Hose
Ends also
Available in:
**Black &
Super Nickel**



Hose Ends

AN-4	100004	\$ 8.10
AN-6	100006	\$ 8.63
AN-8	100008	\$ 10.89
AN-10	100010	\$ 14.21
AN-12	100012	\$ 19.44
AN-16	100016	\$ 26.69
AN-20	100020	\$ 42.11



Swivel Ends allow one to position hose end after it
has been installed on hose.

45 Degree



Fixed Swivel

AN-4	104504 ...	\$ 18.99	204506 ...	\$ 23.22
AN-6	104506 ...	\$ 20.88	204508 ...	\$ 27.23
AN-8	104508 ...	\$ 24.62	204510 ...	\$ 31.69
AN-10	104510 ...	\$ 29.16	204512 ...	\$ 37.98
AN-12	104512 ...	\$ 35.19	204516 ...	\$ 42.56
AN-16	104516 ...	\$ 39.29	204520 ...	\$ n/a

90 Degree



Fixed Swivel

AN-4	109004 ...	\$ 19.34	209006 ...	\$ 22.77
AN-6	109006 ...	\$ 20.88	209008 ...	\$ 28.00
AN-8	109008 ...	\$ 24.62	209010 ...	\$ 31.69
AN-10	109010 ...	\$ 29.16	209012 ...	\$ 38.03
AN-12	109012 ...	\$ 35.19	209016 ...	\$ 42.56
AN-16	109016 ...	\$ 40.04	209020 ...	\$ n/a

180 Degree



Fixed Swivel

AN-4	118004 ...	\$ 24.22	218006 ...	\$ 25.62
AN-6	118006 ...	\$ 25.92	218008 ...	\$ 30.29
AN-8	118008 ...	\$ 29.82	218010 ...	\$ 34.06
AN-10	118010 ...	\$ 33.01	218012 ...	\$ 42.25
AN-12	118012 ...	\$ 37.42	218016 ...	\$ 55.41

Hose Ends also Available in: 30, 60, 120 & 150 Degree



Push-On Hose

CPE elastomer tube, textile braid reinforced with CPE elastomer cover.
Max operating temperature of 250°. *Ideal for:* Fuel, Air & Water.

Hose From..
\$4.10/ft



Hose &
Fittings
Blue or
Black



90

Push-On Hose Clamp Hand Tool

XRP Push-on hose clamp pliers. Specially
designed for XRP hose clamps for ease of
installation and removal. Manufactured from
steel with rubberized grips.

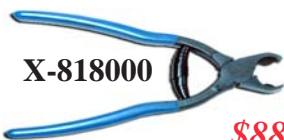

X-818000

\$88.22

AN4	X-230004	\$ 5.16	X-239004	\$ 17.19
AN6	X-230006	\$ 5.16	X-239006	\$ 18.41
AN8	X-230008	\$ 6.14	X-239008	\$ 22.12
AN10	X-230010	\$ 8.30	X-239010	\$ 25.34
AN12	X-230012	\$ 13.27	X-239012	\$ 30.12

Also in Stock: 30 45 60 120 150 180 Deg!

Same Day, Low Cost
Fast Worldwide Shipping!

www.DragParts.com



Hose Fitting Assembly

Online Assembly



1. Wrap hose tightly with tape at cutting point. Using a fine tooth hacksaw, cable cutters or radiac wheel, cut the hose in the middle of the tape. Remove tape after cutting being careful not to fray the braid.

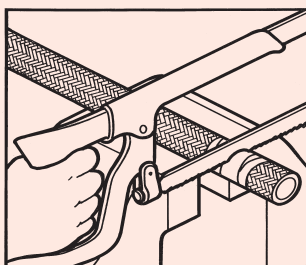

2. Slip hose into socket to the depth indicated by the hose insertion mark on the outside of the socket. This should be just short of the back of the threads. **VERY IMPORTANT** - Mark hose with tape or suitable marking device at rear of socket. This mark will later indicate to you if the hose has pushed out of the socket during assembly.

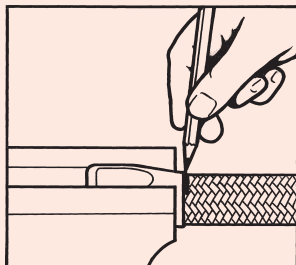

3. Using an anti-seize lubricant, liberally lubricate inside of hose and threads on the nipple. Holding nipple horizontally in a vise equipped with soft aluminum jaws, push socket end carefully with hose nipple with a turning motion and engage nipple threads into those of the socket. Continue tightening by hand as far as possible to make sure that the threads are properly mated and no cross threading has occurred.

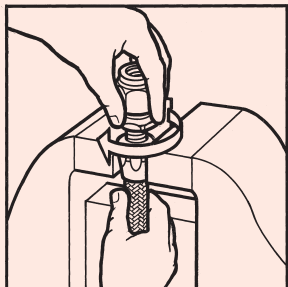

4. Using an aluminum fitting wrench, finish tightening assembly. When properly assembled a small gap of .030" or less should exist between the socket and shoulder of nipple. **NOTE:** Check marks on hose in step 2 for any evidence of push out. Hose assembly must be cleaned and tested to twice the operating pressure.

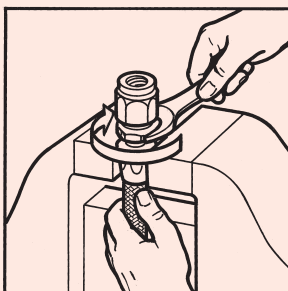

No more Bloody Fingers!

Assemble Braided Stainless Steel hose without poking your fingers. Ideal for racers and performance enthusiasts who have experienced the painful challenge of installing the AN socket.



How-To Demo

- KT-468 3pc Kit AN4-6-8 \$ 75
- KT-681 3pc Kit AN6-8-10 ... \$ 79
- KT-1016 3pc Kit AN10-12-16 \$ 89
- KT-416 6pc Kit AN4-16 \$149
- KT-409 Push-on Assy Press \$249

Teflon Hose Separating Tool

Easiest way to assemble braided stainless steel AN3 & AN4 Teflon Hose.



\$41

X-821060



AN3-20



Professional Aluminum Wrenches

Precisely sized for a perfect fit on AN fittings. Anodized in colors, XRP wrenches are fully radiused to fit your hand. Machined from heat treated 2024 aluminum alloy.

X-750000 \$89

Aluminum Vice Jaws

Vice Jaw inserts protect your hose ends during assembly. Each jaw has a magnetic backing to prevent them from falling out of the vice when opened.



X-821010 \$19



Robert Mills



**Professional
Products
at Sportsman
Prices!**



Extensive Online
Fitting Selection

AN Fittings



800/576-7661

Hex Pipe Plug

Internal hex for smooth finish and easy installation.



1/8	X-993202 (pr)	\$ 2.75
1/4	X-993203 (pr)	\$ 2.75
3/8	X-993204 (pr)	\$ 3.48
1/2	X-993205	\$ 3.68
3/4	X-993206	\$ 4.66

EPR O-Rings

Long Lasting - Won't Shrink

AN3	X-803003	\$ 4.06
AN4	X-803004	\$ 4.64
AN6	X-803006	\$ 5.55
AN8	X-803008	\$ 5.55
AN10	X-803010	\$ 8.75
AN12	X-803012	\$ 8.75
AN16	X-803016	\$ 5.00*
AN20	X-803020	\$ 6.89*



10
Pack
Gas
E85
Alcohol
& Nitro

* packs of five

AN Flare Reducers



Female to Male

AN6-4	X-995006	\$ 7.54
AN8-6	X-995008	\$ 8.77
AN10-6	X-995010	\$ 9.64
AN10-8	X-995011	\$ 9.64
AN12-8	X-995012	\$ 11.45
AN12-10	X-995013	\$ 11.45
AN16-12	X-995017	\$ 27.48

Most Fittings are available in: Red/ Blue, Black and Super Nickel



Flare Plug



Port Plug



Flare Cap



Hex Nut

AN-3	X-980603	\$ 1.59	X-981403	\$ 1.93	X-992903	\$ 2.08	X-992403	\$ 1.05
AN-4	X-980604	\$ 1.59	X-981404	\$ 2.29	X-992904	\$ 2.42	X-992404	\$ 1.02
AN-6	X-980606	\$ 1.59	X-981406	\$ 2.36	X-992906	\$ 3.94	X-992406	\$ 1.17
AN-8	X-980608	\$ 2.96	X-981408	\$ 3.71	X-992908	\$ 4.66	X-992408	\$ 2.26
AN-10	X-980610	\$ 3.80	X-981410	\$ 5.58	X-992910	\$ 5.71	X-992410	\$ 2.29
AN-12	X-980612	\$ 5.55	X-981412	\$ 8.26	X-992912	\$ 7.54	X-992412	\$ 2.61
AN-16	X-980616	\$ 6.38	X-981416	\$ 9.41	X-992916	\$ 8.67	X-992416	\$ 4.64

Flare to Pipe Adapters



Straight



45 Degree



90 Degree

Flare - Pipe

AN-3.....1/8	981603	\$ 2.57	982303	\$ 8.07	982203	\$ 8.23
AN-4.....1/8	981604	\$ 2.57	982304	\$ 8.21	982204	\$ 8.35
AN-6.....1/4	981606	\$ 2.77	982306	\$ 8.44	982206	\$ 8.59
AN-6.....3/8	981666	\$ 3.59	982366	\$ 11.32	982266	\$ 11.55
AN-8.....1/4	981607	\$ 3.71	982307	\$ 14.46	982207	\$ 14.46
AN-8.....3/8	981608	\$ 3.71	982308	\$ 10.24	982208	\$ 10.45
AN-8.....1/2	981688	\$ 5.44	982388	\$ 16.28	982288	\$ 16.59
AN-10....1/2	981610	\$ 5.53	982310	\$ 16.14	982210	\$ 16.45
AN-10....3/4	981613	\$ 10.12	982313	\$ 24.10	982213	\$ 24.10
AN-12....3/4	981612	\$ 10.12	982312	\$ 24.10	982212	\$ 24.10

Flare Adapters

AN-3	981503	\$ 3.06	AN Flare
AN-4	981504	\$ 3.06	Coupler
AN-6	981506	\$ 3.06	
AN-8	981508	\$ 5.44	
AN-10	981510	\$ 6.21	
AN-12	981512	\$ 12.06	
AN-16	981516	\$ 17.36	



4-3	991902	\$ 4.59	AN Flare
6-4	991906	\$ 4.69	Reducer
8-6	991912	\$ 6.70	
10-6	991914	\$ 8.27	
10-8	991915	\$ 8.01	
12-8	991919	\$ 12.39	
12-10	991920	\$ 12.39	
16-10	991922	\$ 16.91	
16-12	991923	\$ 16.91	
20-12	991925	\$ 23.45	
20-16	991926	\$ 27.77	



Black
or Blue



AN Thread Sizes

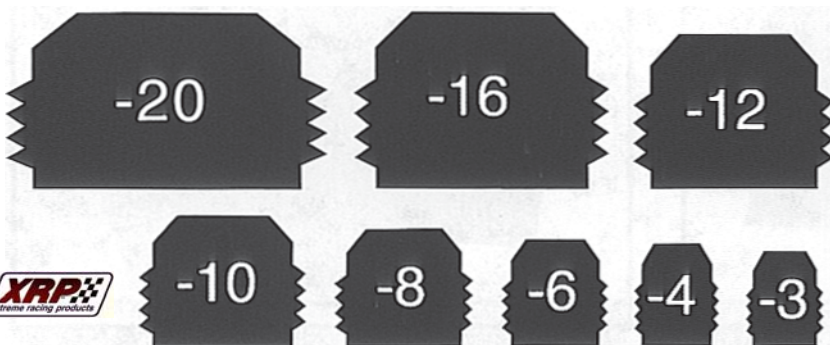

AN Size	Metal Tube O.D.	Thread Size
4	1/4"	7/16-20 UNJ
6	3/8"	9/16-18 UNJ
8	1/2"	3/4-16 UNJ
10	5/8"	7/8-14 UNJ
12	3/4"	1-1/16-12 UNJ
16	1"	1-5/16-12 UNJ
20	1-1/4"	1-5/8-12 UNJ



FREE Catalog!

800/576-7661



Male Flare to Female Swivel Tee



AN4	X-900304....	\$ 15.17
AN6	X-900306....	\$ 18.78
AN8	X-900308....	\$ 27.44
AN10	X-900310....	\$ 33.23
On Run AN12	X-900312....	\$ 34.67
AN16	X-900316....	\$ 83.36



On Side

Fuel Pressure Take Off Adapters



Tapped
1/8 Pipe
on the
Hex



X-700192	-6 Male to -6 Male	\$ 9.24
X-700194	-6 Male to 3/8" Male NPT	\$ 9.24
X-700195	-6 Male to -6 Female Swivel	\$ 11.04
X-700196	-8 Male to -8 Male	\$ 10.80
X-700198	-8 Male to 3/8" Male NPT	\$ 10.80
X-700199	-8 Male to -8 Female Swivel	\$ 12.83
X-700202	-10 Male to -10 Female Swivel	\$ 16.52



Hose Finishers

Anodized Aluminum
Stainless-Steel
Worm Clamp

AN4	X-550104	\$ 4.81
AN6	X-550106	\$ 4.92
AN8	X-550108	\$ 5.13
AN10	X-550110	\$ 6.14
AN12	X-550112	\$ 7.21

Aluminum Fill Caps



Steel & Alum
Weld Bungs



JAZ Caps



From \$30

O-Ring

Bung Size: 1.625 & 2.00"
Threads: 1.25 & 1.50"

Female Swivel Coupler



AN6	X-900104	\$ 7.32
AN6	X-900106	\$ 7.49
AN8	X-900108	\$ 9.03
AN10	X-900110	\$ 10.97
AN12	X-900112	\$ 15.38
AN16	X-900116	\$ 21.40



Female Swivel Coupler - 90 Deg

AN4	X-929004 ...	\$ 14.75
AN6	X-929006 ...	\$ 14.75
AN8	X-929008 ...	\$ 16.64
AN10	X-929010 ...	\$ 21.05
AN12	X-929012 ...	\$ 22.73
AN16	X-929016 ...	\$ 46.83



Tube

AN6	X-929106 ...	\$ 15.84
AN8	X-929108 ...	\$ 16.75
AN10	X-929110 ...	\$ 21.40
AN12	X-929112 ...	\$ 27.67
AN16	X-929116 ...	\$ 41.84



Forged

Female to Male Swivel Adapters

Tube

45 & 90 Degrees

Forged

Sizes: AN4 -16

Great for Tight Spaces

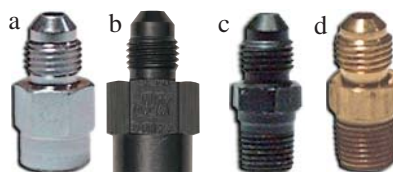

Gauge Fittings

Connect your
Gauges to
AN Hoses



a.	X-705003	AN3 Male Str to 1/8 Fem NPT	\$ 5.85
a.	X-705004	AN4 Male Str to 1/8 Fem NPT	\$ 2.26
b.	X-795003	AN3 Male Str to 1/8 Fem NPT	\$ 7.26
b.	X-795004	AN4 Male Str to 1/8 Fem NPT	\$ 7.26
c.	E-248-3A	AN3 Male Str to 1/8 Male NPT	\$ 1.99
d.	E-248-3	AN3 Male Str to 1/8 Male NPT	\$ 1.99
e.	X-705093	AN3 90 Deg to 1/8 Fem NPT	\$ 5.74
e.	X-705090	AN4 90 Deg to 1/8 Fem NPT	\$ 4.06

Also 1/4 NPT in Stock. Save \$50 - Code CAT50

Swivel Pipe Adap

AN to Male Pipe

Straight or 90 Degrees



AN3 - AN12

1/8 to 3/4 NPT





Extensive Online
Fitting Selection

800/576-7661

BILLET Aluminum Weld Bungs ... Ideal for Fuel & Oil Systems



AN Thread

Female

Male



AN6	X-987106	\$ 10.62	X-997106	\$ 4.25
AN8	X-987108	\$ 11.27	X-997108	\$ 5.64
AN10	X-987110	\$ 13.30	X-997110	\$ 6.63
AN12	X-987112	\$ 13.74	X-997112	\$ 11.25
AN16	X-987116	\$ 19.82	X-997116	\$ 13.02
AN20	X-987120	\$ 27.44	X-997120	\$ 17.54



Pipe Thread

Hex

Round



1/8	X-996701	\$ 3.97	X-996801	\$ 3.41
1/4	X-996702	\$ 4.43	X-996802	\$ 3.50
3/8	X-996703	\$ 5.53	X-996803	\$ 3.94
1/2	X-996704	\$ 6.51	X-996804	\$ 4.31
3/4	X-996706	\$ 9.31	X-996806	\$ 4.50
1"	X-996708	\$11.04	X-996808	\$ 5.16

What are AN ORB Adapters?

Male AN Flare to Inverse Male AN with an O-Ring.

High
Contour
Flow!



Anodized
Black



Straight

45 Degree

90 Degree

AN3	X-980003	\$ 6.02	X-984503	n/a	X-989003	\$15.12
AN4	X-980004	\$ 6.34	X-984504	\$11.34	X-989004	\$11.28
AN6	E-815-6	\$ 5.26	X-984506	\$14.81	X-989006	\$13.52
AN8	E-815-8	\$ 6.86	X-984508	\$16.98	X-989008	\$15.52
AN10	E-815-10	\$ 9.18	X-984510	\$25.64	X-989010	\$23.75
AN12	E-815-12	\$ 11.63	X-984512	\$38.64	X-989012	\$36.51
AN16	E-815-16	\$ 17.74	X-984516	\$44.25	X-989016	\$44.25
AN20	E-815-20	\$ 21.76	X-984520	\$58.49	X-989020	\$58.49

ORB Reducer



E-919-6-8	\$ 8.99
E-919-6-10	\$ 11.99
E-919-8-10	\$ 11.99
E-919-8-12	\$ 13.99
E-919-10-12	\$ 13.99
E-919-12-16	\$ 21.99
E-919-16-20	\$ 26.99

Reducers are designed to reduce the inverse flare ORB side to a smaller male AN size. O-ring will be on the larger AN side.

ORB Expander



E-919-8-6	\$ 8.99
E-919-10-8	\$ 8.99
E-919-12-8	\$ 8.99
E-919-12-10	\$ 13.99
E-919-16-8	\$ 21.99
E-919-16-12	\$ 21.99
E-919-20-16	\$ 26.99

ORB Expanders are designed to expand the inverse flare ORB side to a larger male AN size. O-ring will be on the smaller AN side.

High Quality Fasteners in Stock



- * Blower Pulley Bolts
 - * Crank Hub Bolts
 - * Valve Cover Studs
 - * Oil Pan Studs
 - * Allen Socket Head
 - * 12pt Nuts & Bolts
 - * Flex Plate Bolts
 - * Flywheel Bolts
 - * Header Studs
- 1000's IN STOCK!**



Sizes in Stock: 10-32 1/4 5/16 3/8 7/16 1/2 5/8 3/4

Liquid Filled Pressure Gauge

Great for *Oil* or *Fuel Pressure*, or *Blower Boost*. Liquid filled for stability and longevity.



Shock Resistance !

X-710000	0-15psi
X-710030	0-30psi
X-710060	0-60psi
X-710100	0-100psi

1.50in
Diameter

\$39.99



Same Day, Low Cost
Fast Worldwide Shipping!

www.DragParts.com

Intake Gaskets

Accu-Seal is the first choice of engine builders and race teams. Delivers precision fit, durability and economy all in one. **Pro** utilizes state-of-the-art materials such as *proprietary steel core laminate with teflon coating, viton oil seals, and molded rubber* for selected Oil Pan and Valve Cover applications.

- SCE-11101 SBC 1.20 x 2.00 Port \$ 14.99/pr
- SCE-11102 SBC 1.25 x 2.275 Port \$ 14.99/pr
- SCE-11103 SBC 1.25 x 2.275 (1266) Thick \$ 23.99/pr
- SCE-113102 BBC 1.8 x 2.5 \$ 15.99/pr
- SCE-113115 BBC 1.8 x 2.5 No Top bolt \$ 15.99/pr
- SCE-113116 BBC 1.8 x 2.5 No Top bolt. Thick \$ 26.99/pr
- G-2210 426 Hemi Stock Port 2.375 \$ 17.99/pr
- G-2212 426 Hemi Medium Port 2.750 \$ 17.99/pr
- G-2215 426 Hemi KB ALPE 10 Bolt \$ 19.99/pr
- SCE-167101 392 Hemi Stock Port \$ 15.99/pr
- SCE-167103 392 Lrg Stock ALPE 417 Don \$ 14.99/pr
- G-2218.10 Hemi/BAE/TFX End Rail \$ 9.99/10 pk



SCE-113102

SCE-11101

Sold in Pairs!

SCE-11102



SCE-113115 SCE-113116

SCE-11103

G-2210
G-2212

Silicone Ports

- SCE-211101 SBC 1.20 x 2.00 Port (1256) .. \$ 19.99/pr
- SCE-211102 SBC 1.25 x 2.20 Port (1205) .. \$ 21.99/pr
- SCE-211128 SBC 1.30 x 2.24 Port (1206) .. \$ 22.99/pr
- SCE-213102 BBC 1.80 x 2.50 Port (1211) .. \$ 25.99/pr
- G-2247 BB Chevy 1.80 x 2.50 Port (1275) .. \$ 15.99/pr
- SCE-213115 BBC 1.80 x 2.50 Port (1275) .. \$ 19.99/pr
- SCE-218101 Big Chief/ Big Duke (1298) ... \$ 26.99/pr
- SCE-267101 354-392 Hemi Fuel/ Alky \$ 18.99/pr



SCE-211128

SCE-213102



SCE-218101

G-2247

Oil Pan Gaskets

Superb Quality - Reusable
Gas - E85 - Alcohol - Nitro

PREMIUM - Street/ Strip

- SCE-111091 SBC Pre 1974 Thin Front Seal \$ 13.99
- SCE-113090 BBC .090 Thick \$ 13.99
- SCE-113091 KB Olds .090 Thick \$ 19.99
- SCE-113092 Merlin Block, Large Stroke \$ 14.99
- SCE-167091 417 Hemi \$ 18.99
- G-2110 426 Hemi, KB, BAE \$ 11.95
- G-2114 TFX-92 \$ 12.95
- G-2118 TFX-96 \$ 12.95



PROFESSIONAL Oil Pan Gaskets

- * Steel-Core
- * Teflon Coated
- * Reusable



All Fuels Including Nitro

- SCE-211090 SB Chevy 1pc Molded Pre 1986 \$ 28.99
- SCE-211092 SB Chevy 1pc Molded Post 1986..... \$ 28.99
- SCE-213090 BB Chevy 1pc Molded Gen 4 \$ 35.99
- SCE-213091 BB Chevy 1pc Molded Gen 5-6 \$ 28.99
- SCE-235091 BB Ford 1pc Molded \$ 30.99
- SCE-274090 481X Rodeck \$ 37.99
- SCE-266091 KB BAE Hemi \$ 37.99
- SCE-261091 TFX 92 Hemi \$ 46.99
- SCE-261092 TFX 96 Hemi \$ 37.99

Simply
the Best.

Engine

Seals



Front



Rear Viton

- | | | | | |
|----------|-----------|---------|-----------|---------|
| SB Chevy | SCE-11102 | \$ 4.99 | SCE-21105 | \$28.99 |
| BB Chevy | SCE-11302 | \$ 8.99 | SCE-21305 | \$21.99 |
| 351W | SCE-13602 | \$ 5.99 | SCE-23605 | \$20.99 |
| BB Ford | SCE-13502 | \$ 5.99 | SCE-23505 | \$30.99 |
| SB Mopar | SCE-16902 | \$ 8.99 | SCE-16904 | \$17.99 |
| BB Mopar | SCE-16402 | \$ 8.99 | SCE-26405 | \$30.99 |
| 417 Hemi | SCE-16702 | \$ 8.99 | SCE-16705 | \$21.99 |
| 426 Hemi | SCE-16602 | \$ 8.99 | SCE-26605 | \$30.99 |



Valve Cover Gaskets

PREMIUM Rubber with Steel Core

- G-2320 SB Chevy \$ 12.95
- G-2325 BB Chevy \$ 14.95
- G-2330 SB Ford \$ 13.95
- G-2335 351C Ford .. \$ 14.95
- G-2340 428 Ford \$ 16.95
- G-2345 429-460Ford \$ 16.95
- G-2305 SB Mopar \$ 15.95
- G-2355 330-455 Olds \$ 14.95
- G-2350 Pontiac \$ 15.95



Re-Usable! **Sold in Pairs!**

STREET/ STRIP Laminated Cork/ Silicone

- SCE-211075 SB Chevy \$ 27.99/pr
- SCE-213075 BB Chevy .125 \$ 32.99/pr
- SCE-213076 BB Chevy .250 \$ 37.99/pr
- G-2310 426 Hemi \$ 24.99/pr

Seals where others won't

PROFESSIONAL Steel-Core & Teflon Coated

- SCE-213078 BB Chevy
- SCE-218078 Big Chief
- SCE-218078 KB Olds
- SCE-266075 KB BAE 1/4 holes
- SCE-261075 KB BAE 5/16 holes
- SCE-267077 Hemi Early



**Superb Quality - Reusable
Gas - E85 - Alcohol - Nitro**

Front Cover



Includes: Timing Cover, Water Pump & Fuel Pump Gaskets

- SCE-11100 SB Chevy
 - SCE-11300 BB Chevy
 - SCE-13600 SB Ford
 - SCE-13500 BB Ford
 - SCE-15200 351C Ford
 - SCE-16900 SB Mopar
 - SCE-16400 BB Mopar
 - SCE-16600 426 Hemi
- \$7.99ea**

Premium Blower Gaskets

These premium gaskets are race tested and proven in Top Fuel/ Alcohol & Blown Gas.

Blower Base

- G-2022 6.71 \$ 9
- G-2022.3 3-Pack ... \$ 18
- G-2028 8-10.71 ... \$ 9
- G-2028.3 3-Pack \$ 24
- G-2032 14.71 \$ 12
- G-2032.3 3-Pack \$ 32



Blower Inlet

- G-2012 Small w/o Screen \$ 7
- G-2012.3 3-Pack Special \$ 15
- G-2014 Small w/ Screen \$ 9
- G-2014.3 3-Pack Special \$ 22
- G-2016 Large w/o Screen \$ 7
- G-2016.3 3-Pack Special \$ 15



Re-Usable!

- B-5019 Inj Hat Stud Kit \$ 12



Bearing & other blower gaskets See Page 21

Carb Base Gaskets

Holley Carb gaskets are heat resistant and standard thickness. Will handle the rigors of **supercharged** engines.



- G-2070 Carb Gasket \$ 3.25
- G-2072 Dom Gasket \$ 3.25
- SCE-355 4 Port Gasket \$ 2.99



Enter our \$100 Drawing !



License Plate Frames



Send us a pic of your ride with our frame and you'll be entered in the \$100 drawing !



FREE Catalog!

Benefits of Using Copper

Conductivity. Copper is the standard by which all other conductors are measured, therefore a copper gasket provides superior thermal conductivity, acting to stabilize head and block temperatures which makes tuning easier.

25% Coefficient of Elasticity. One of the properties of copper is that it stretches before a catastrophic failure, providing an extra measure of safety in case of severe detonation.

Strength. Copper (in the form SCE uses) has a tensile strength of approximately 32,000 psi, compare this to the 1200 to 1800 psi tensile of most facing materials used on conventional performance head gaskets.

Copper Head Gaskets

**Premium Quality * Properly Annealed
Perfect Fit * Dead Soft Copper**

**Track Tested & Proven by Top Fuel
& Alcohol Racers**

SCE-31541 304 Stainless Steel O-Ring Wire 15ft \$12.99



Original (Good)



.032 \$ 121/pr
.043 \$ 121
.050 \$ 136
.062 \$ 151
.070 \$ 181
Sold in Pairs .080 \$ 181

The World's First Self-Sealing

SCE's **TITAN series** gaskets provide unbeatable strength and user friendly installation. This patented headgasket gives you the best of both worlds.

The combustion sealing strength of a SCE copper headgasket and the confidence of **built-in coolant and oil passages!** The perfect racing and performance Copper Headgasket!

Self-Sealing (Great)



.032 \$159
.043 \$159
.050 \$177
.062 \$185
.070 \$207
Sold in Pairs .080 \$207

Self-Sealing & Integrated O-ring

Same as above but with a **Integrated Steel O-Ring** means there is no need to machine your Block or Heads!

Embedded silicone to seal oil and water passages. Soft copper is ready to use.

Self Sealing with O-Ring (The Best!)

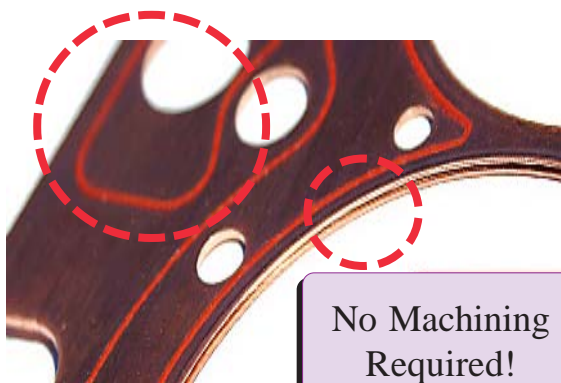

.043 \$217
.050 \$235
.062 \$260
.070 \$302
.080 \$302

No Machining
Required!

Sold in Pairs

**How to Install
Copper Gaskets**





Professional
Products
at Sportsman
Prices!



Large Selection
Gaskets Online

Copper Gaskets⁵¹

800/576-7661

Pro-Copper Exhaust Gaskets



SCE Copper Exhaust Gaskets will permanently seal a warped or uneven flange.

Reusable!

Raised Embossed from **\$34/pr**

Non-Embossed from **\$66/pr**

In Stock: Chevy, Mopar, Ford, More...

Collector Gaskets

Use SCE copper collector gaskets for maintenance free operation.



Sizes: 2.5, 3, 3.5in **\$14.99/pr**

SCE's Graph-Form Exhaust Gaskets

Offer easy-to-fit positive sealing in any severe duty exhaust systems from racing & performance to mild street applications. Will seal on warped, pitted or uneven surfaces up to 1/16".
Outperforms all competing brands!



Exclusive high-density 1/8" thick carbon-graphite material outperforms all competing brands in sustained high temperature operation.



Scan for sizes, part numbers, benefits & discounted prices



In Stock:

SB Chevy
BB Chevy
Late Hemi
Early Hemi
Donovan
SB Mopar
BB Mopar
Ford 429
Arias

Most **\$28/ pr**

Premium Zoomie Header Kits

FC/ Altered

(Double Wall)

2.25 or 2.50" Diameter

Weld-Up

Kits

Dragster

(Single Wall)

2.25 or 2.50" Diameter

**Header Kits
IN STOCK:**

SB Chevy
BB Chevy
392 Hemi
426 Hemi
440 Mopar
BAE, TFX,
KB, Veney

USA Quality

These are superior to your plain old muffler shop steel!

Single Wall ... **\$395**

Double Wall ... **\$495**

Includes: Straps/ Flanges



**3/8" Thick Flanges
.065 Wall Thickness**

Zoomie Covers

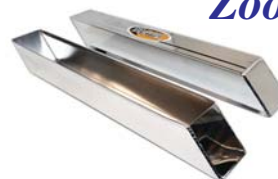

Fits 2.25 & 2.50"

Sheet Metal Aluminum
Keeps Cold Air off Valves
Won't Rust

C-8140 **\$98**

Tested and Proven for over 40 years by top teams like:

John Force, Frank Manzo, Jim Dunn, Jay Payne, etc..

Billet Gear Drives

*Proven by Top Fuel &
Alcohol Teams*

- Billet Alum Cover
- Chromoly Gears
- Fixed Idler
- Premium Fasteners



One of the strongest on the market !

RCD-251000-0003 SBC	\$1053
RCD-251000-0006 SBC w/ BBC ...	\$1053
RCD-251000-0009 SBC Tall.....	\$1147
RCD-251000-0012 SBC Tall w/ BBC	\$1147
RCD-251500-0002 BBC	\$1076
RCD-253500-0004 TFX	\$1257
RCD-253500-0042 KB, BAE Tall ..	\$1244
RCD-254000-0040 417 Donovan	\$1147

Casale Cast Gear Drive

Fits 440/ 426 Mopar, HEMI Tall Cam
(KB, BAE, AA500)

ACC-2745 **\$749**



Great Features!

- 3/8 Cam Hex
- Heat-Treated Steel Gears
- Fixed Idler Gear
- 3pc Cam Torrington

Fowler Billet Gear Drive

KB-Olds and Arias Century

ACC-2740 ... **\$1095**



Gear Drive Components

BILLET !!

- RCD-300205-0028 Cam Cover (RCD SBC) **\$ 143**
- RCD-300205-0032 Cam Cover All Others **\$ 169**
- RCD-300707-0002 Fuel Pump Alum Clamp **\$ 153**
- B-2121 Cam Cover (KB-BAE-TFX, etc..) **\$ 89**
- RCD-300209-03 5/8-3/8 Steel Hex Adap ... **\$ 43**
- B-2113 3/8 Premium Steel Shaft 3" **\$ 69**
- B-2115 3/8 Premium Steel Shaft 5" **\$ 69**
- RCD-300201-0032 QR RCD Ext 3 or 5" ... **\$ 494**
- B-2123 QR Pump Ext Smooth 3" .. Fits RCD **\$ 189**
- B-2125 QR Pump Ext Smooth 5" .. Fits RCD **\$ 189**
- B-2126 QR Pump Ext 5" Fits Non-RCD **\$ 189**
- B-2128 QR Pump Ext 6" Fits Non-RCD **\$ 189**



Gear Drive
Assemblies &
Parts Online

Heat Treated 4340 Crank Gears



Std, .010 .020
from **\$119**



Choice of:
Double Keyway or,
Splined: RCD or PSI





Cast Gear Drives

*Will handle the rigors
of blown and nitrous
engines!*

Cast Alum Cover
Chromoly Gears
Fixed Idler
Quality Fasteners
3 PC Torington



Milodon
INC.



Your Best Value!

Removable Cam Cover
Adjustable Bolt Pattern on Cam Gear
3pc Bearing to Control Cam Movement

MIL-12000 SB CHEVY	\$ 598
MIL-12250 SB CHEVY Injected ...	\$ 664
MIL-12600 BB CHEVY	\$ 688
MIL-12700 BB CHEVY Injected ..	\$ 764
MIL-12608 BB CHVY Mk VI	\$ 750
MIL-12706 BB CHVY Mk VI Inject	\$ 841
MIL-13000 BB MPR/ Hemi	\$ 697
MIL-13250 BB MPR/ Hemi Injected	\$ 721
MIL-14900 DVD: How to Degree a Cam	\$ 33

Quality Belt Drives



*Cam timing adjustment is made externally providing the easiest and most accurate tuning available.

*Billet aluminum Spider is made from 2024-T6 and is available as a available to run distributor drives, fuel pumps or oil pumps off front of cam.

*Hard-coated Billet Alum 7075 Upper Pulley features patented High Torq Drive™ tooth configuration.

*Teflon® coated high vacuum cam and crank seals.

*Patented High Torq Drive™ reinforced belt operates dry and spins with less friction than timing chains or gear drives and also absorbs harmonics.

*Crank Pulley is heat-treated steel and incorporates a High Torq Drive™ tooth configuration.



*Hardware is all Grade 8 Allen or Torx™ head design.

Complete Drives

JES-KBD-31000 SB Chevy Standard	\$ 979
JES-KBD-31200 SB Chevy w/ BB Snout ..	\$1049
JES-KBD-32000 BB Chevy Standard	\$1075
JES-KBD-35000 426 Hemi & 440 Mopar	\$1299



Replacement Parts

JES-BEL-30990 SB Chevy Belt	\$ 110	
JES-BEL-31010 BB Chevy Belt	\$ 115	
JES-SEL-37200 SB Chevy Seal	\$ 24	
JES-SEL-37300 BB Chevy Seal	\$ 24	
JES-SEL-38000 SB/BB Cam Seal	\$ 24	



Aluminum Timing Cover

Polished Aluminum Cover,
Gasket, Seal & Chrome Bolts!

ACC-2622 SB Chevy	\$ 29.99
ACC-2632 BB Chevy	\$ 39.99
ACC-2635 BBC Gen 5	\$ 39.99*
ACC-2636 BBC Gen 6	\$ 39.99*

* Cover Only

Drive your Mechanical Fuel Pump off a Jesell Belt Drive



SB & BB Chevy

Billet Bracket w/ Mntng Hardware \$199
3/8 or 1/2 Left Hand Hex Drive \$ 37

BUY * SELL * TRADE



FREE Catalog!

www.DragParts.com



Motor oils, transmission fluids and gear oils are flowing lubricants that provide a film barrier between metal surfaces pressing or rubbing together. The greater the film strength, the better the oil. However, in extreme pressure metal-to-metal areas, the film strength of oil is seriously thinned and is often completely squeezed out. On the other hand, **Prolong** is a bonding lubricant. **Prolong AFMT™** interacts with metal surfaces in a molecular and chemical process to create a protective buffer on the surface of the metal. This is not a film or coating over the metal. Molecules in the AFMT™ formula are polarized and actually bond with the metal surface. The layer of AFMT™ molecules is activated by extreme pressure and heat, meaning that **Prolong** lubrication performs best right where it is needed most! The result, AFMT™ significantly reduces harmful friction and heat.

Fortified with Prolong's advanced technology, nothing works better than Prolong Oil Stabilizer to help **solve lubrication-related** problems. Other oil stabilizers on the market do not include the necessary additives provided by today's motor oils, such as antioxidants. The formulation of Prolong Oil Stabilizer includes: Prolong's AFMT™ (Anti-Friction Metal Treatment) advanced technology as well as vital additives to provide a completely formulated oil stabilizer product, which sets this product apart from the other competitors. (32oz)

Works great in high horsepower, drag racing engines especially those injected or blown.

Fuel: Gas, methanol, diesel or nitro fuels.

Oil Stabilizer



PSL13032.. **\$9.99**

Prolong Waterless Wash & Shine is a revolutionary new method of washing and shining your car in less than 15 minutes without water. No buckets, no hoses, no rinsing and drying! Simply spray on the surface and wipe dry. With Waterless Wash & Shine you can conveniently and quickly wash your race or show car anywhere, anytime. Leaves a protective film that provides gloss, color and smoothness that conventional car washes fail to deliver. (17oz)

Wash & Shine



Safe & effective on race and show cars. PSL64017.. **\$6.99**



50W Oil for Alky & Nitro

Nitro 50W Racing Oil, Specifically developed for racing engines fueled by Alcohol and Nitromethane. Exceeds the demands of high displacement, high RPM racing engines. (1 Gallon)

PSL14501.. **\$32.90**

Super Penetrating Lubricant Spray is formulated with AFMT™ (Anti-Friction Metal Treatment) advanced technology to **lubricate, penetrate, and prevent** corrosion, free sticky mechanisms, **displace** moisture, stop squeaks, and reduce friction and wear on all metal surfaces. **Easy-to-apply** protection and lubrication for hundreds of performance & recreational uses as well as industrial applications such as light duty machining, tapping and drilling fluid. (16oz)

Lubricant



Ideal for:

Enderle & Hilborn fuel pumps, barrel valves & shutoffs.

4 oz PSL40004 **\$4.99** 16 oz PSL40016 **\$9.99**

We also Stock Pro-One Products



**Oil Stabilizer
 Penetrating Oil
 Greases
 Engine Treatment**





Professional
Products
at Sportsman
Prices!



Complete Lubes
& Oils Online

Lucas Products ⁵⁵



800/576-7661

Racing Oil Key Benefits:

- High Zinc Fortified
- Perfect oil for high RPM engines
- Extra Protection
- Lower Oil Temperature
- Compatible With Methanol Or Racing Gas
- Less Drag For More Horsepower!



Break-in Engine Oil

- LOP-10635 20W-50 Oil 1 Qt \$ 7.99
- LOP-10636 20W-50 Oil 5 Qt \$ 29.99

Racing Engine Oil

- LOP-10620 20W-50 Oil 1 Qt \$ 8.99
- LOP-10621 20W-50 Oil 5 Qt \$ 35.99
- LOP-10044 50W Oil 1 Qt \$ 8.99
- LOP-10095 50W Oil 5 Gal \$ 112.99



Synthetic Engine Oil

- LOP-10615 20W-50 Oil 1 Qt \$ 13.99
- LOP-10616 20W-50 Oil 5 Qt \$ 56.99

Hot Rod & Classic Engine Oil

- LOP-10683 10W-40 Oil 5Qt \$ 35.99



Because many of these very special machines often spend long periods off the roads, special additives are formulated into the oil. Similar to Lucas' Marine oils that provide rust and corrosion protection

Lower cylinder head temps. **Super Coolant**
Allow advanced timing and more horsepower.
Reduce operating temperatures by up to 20°.
Prevents corrosion and deposits that cause leaks, overheating, and cooling system failures.

- LOP-10640 Super Coolant 16oz .. \$ 12.99



Transmission Sure Shift

*Smooth, precise shifting * Extraordinary protection*

This is no normal ATF formulation. It has been developed to give the smooth, precise shifts needed by racers and yet extends a degree of protection not found in any other ATF. This product will stop wear and tear like nothing you've ever tried. **LOP-10052 Sure Shift 1 Qt... \$ 7.99**



SAFEGUARD™ ETHANOL Fuel Conditioner With Stabilizers

Lucas Safeguard™ was developed to specifically address issues associated with using ethanol based fuels. This applies to E-10, E-15, E-85, pure ethanol and any mixtures in between including gasoline. Safeguard™ is completely soluble in all ethanol fuels and will not harm filters. Contains effective additives to prevent rust and corrosion associated with the use of ethanol fuels.



Treats 80 Gallons

- LOP-10670 Ethanol/ Alky Conditioner 5.2oz \$ 6.99

Synthetic Gear Oil

SAE 75W-90 Synthetic Gear Oil is a non-foaming, super slick, long lasting lubricant designed especially for high performance applications where other gear lubricants just aren't good enough. Contains a special additive that cushions gears and resists "squeezing out" under extreme pressure situation. Specially designed to stand up to high temperatures without losing its lubricity.



- LOP-10043 80W-90 1 Qt Non-Syn \$ 8.99

- LOP-10047 75W-90 1 Qt Synthetic \$ 14.99

Extreme Pressure Valve Train Synthetic Grease

Greatly reduces friction on moving parts to prevent galling. Excellent adhesion quality. Excellent on all surfaces requiring an extreme pressure lubricant. Perfect for assembly lube on rod bolts. Protects pushrod ends on initial start up. Essential for roller lifters, rockers, pushrods and camshafts.



- LOP-10563 1 oz Tube \$ 9.99

Semi-Synthetic Assembly Lube

Lucas High Performance Assembly Lube is designed for mechanics and technicians to pre lube bearings, cams, lifters and valve train. The Semi-Synthetic formula that contains ZINC, MOLY and other high pressure additives which offer maximum protection during engine break-in. Super slick and easy to use, Lucas High Performance Assembly Lube will eliminate dry starts and prevent seizing galling and scuffing.



- LOP-10153 Assembly Lube 8oz \$ 7.99

Same Day, Low Cost
 Fast Worldwide Shipping!

www.DragParts.com

Front Offset Drive

Aluminum drive allows one to drive the fuel pump and magneto off the gear drive. Clamps to your fuel pump extension. Gear driven - no belt to replace!



E-4116.M

\$ 637



New

Billet Offset Drives

Accepts Mallory or MSD Mags.
 Belt Driven. Includes Bronze Gear.



Front Pump/
 Magneto Drive
 (Sitko)

Fixed Flange or Adjustable
 Clamp Styles.

Ideal if rear blower clearance is a problem.
 Minimizes the effects of cam flex on timing.

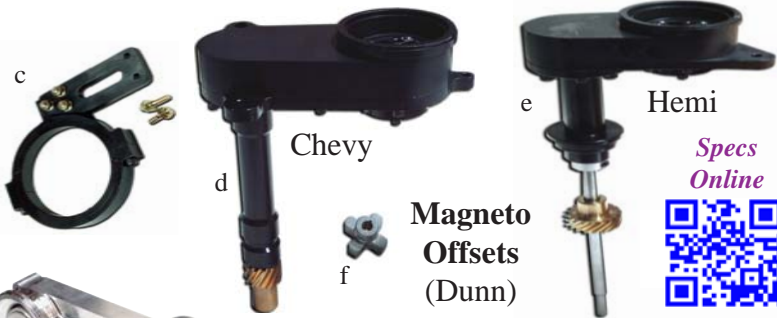

Magneto
 Offsets
 (Dunn)

Specs
 Online



Front Pump/
 Magneto Drive

- a. RCD-302000-0005 Front **\$1049**
- b. I-2062 Front Drive **\$1089**
- c. T-1016 MSD Support **\$ 169**
- d. I-2030 Chevy Offset **\$ 791**
- e. I-2040 KB, TFX, BAE **\$ 893**
- f. I-2037 Cross Coupler **\$ 39**

Front Drive

Move your Distributor or Mag to the front.

Clamps to Pump Extension.
 Uses Std height BBC Base.
 Positions magneto behind
 blower belt.
 Includes Support Bracket.

RCD-302507-0010



\$ 932

Same as unit to the left
 though it does **NOT** require a
 magneto base. Works with
 Mallory or MSD magnetos.

- RCD-302507-0001 CW
- RCD-302507-0002 CCW

Need
 Spark?

Magneto Assembly



Super Mag III
 3.8 amps

Great for supercharged alcohol engines!

Includes: Generator Assembly, Billet Alum Base,
 Pro Coil, QD Wiring, Instructions and Case.

- M-37-36544 LH Hemi Pro Cap
- M-37-33744 RH 392 Hemi Pro Cap
- M-37-59544 RH Chevy Pro Cap
- M-37-59514 RH Chevy Stack Cap

from **\$ 1329**
 Includes padded
 shipping case!

Also Available for Fords & Mopar

Billet Magneto Bases



- a. M-37590 Chevy Base w/ Bronze Gear **\$ 328**
- M-37365 Hemi Straight Base **\$ 299**
- b. RCD-303000-0015 Hemi Angled Base **\$1096**
- c. I-2042 Hemi Hold-Down Clamp **\$ 67**
- d. M-45520 Alum Slip Collar Clamp Hemi **\$ 29**
- e. I-2038 Magneto Clamp Billet Alum **\$ 99**
- f. M-26041A SS Steel Magneto Clamp **\$ 49**
- g. I-2070 Chevy .491 I-2073 .500 Bronze Gear **\$ 49**
- h. E-7025 Hemi Straight Base w/ oil shaft ... **\$ 389**

\$932



New!





Order Magneto
Parts Online



800/576-7661

Magneto Components

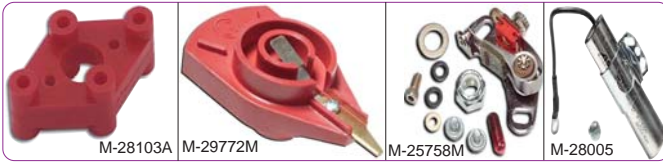

- M-28103A Advance Lock Out **\$34.99**
- M-28995 Rotor (RH) Stack Cap **\$40.99**
- M-28995A Rotor (LH) Stack Cap **\$40.99**
- M-29038 Rotor Adapter **\$10.99**
- M-29772M Rotor (RH) Pro Cap **\$30.99**
- M-29773M Rotor (LH) Pro Cap **\$35.99**
- M-29772C Rotor/Adapter w/ nylon screws **\$61.99**
- M-25758M Premium Contact Points **\$24.99**
- M-28005 .56mf (Large) Condenser **\$38.99**



- M-205XB HEI Stack Cap **\$ 48.99**
- M-29745B HEI Pro Cap **\$ 32.99**
- M-29744B Wire Retainer **\$ 24.99**
- M-26007B 4 Pin Drive Flange **\$ 37.99**
- M-26030 Woodruff Key **\$ 1.95**
- M-28974 Timing Indicator **\$ 5.99**
- M-28862 Wiring Harness **\$ 13.99**

Convert Mallory 4-Pin to X-Driver

Much stronger than the Mallory 4 pins



- I-2016 Adapter Only **\$ 40**
- I-2017 Assembly **\$ 79**
- I-2037 X-Driver **\$ 39**

Magneto Timing Mechanism



Advance & Retard
Magneto Timing
*Operates on
12V or CO2*

IHRA, NHRA, NTPA legal I-2010 12V, I-2012 CO2 .. \$ 709



Need more info
or instructions?

Spark Plug Wire



8mm Plug Wires are designed to withstand temperatures over 500 degrees. Tinned Copper solid core are for points magneto equipped engines.



- I-2222 Most w/ 90 Deg Ends .. **\$ 66**
- I-2212 Hemi w/ Straight Ends **\$ 169**
- I-2231 Bulk Wire red (foot) **\$1.87**

Suppression wire. Add \$10/ set

SUPER-MAG Transformer

COIL is externally mounted making for a more efficient and powerful magneto. HEI style contact terminals resulting in a more positive wire retention.

- M-28900A SMIII Blown Gas/ Alky **\$ 249**
- M-28990 SMV Blown Nitro **\$ 295**
- M-28901 SMV Blown 5-10amp **\$ 439**
- M-28920 SMV+ Injected Nitro **\$ 465**



Oil
Filled

Magneto Timing Buzzer



Lights &
Buzes

*Necessary To
Set Magneto
Timing*



Online
Instructions

I-2098 ... \$ 81.99

Kill Switches



\$ 103



*Premium
Super Mag
Kill Switch*
M-26074 **\$29**

Designed specifically for Mallory & MSD magnetos. Positive push-off. Internally sealed to prevent corrosion. Single or dual mags.

I-2096 Mallory I-2097 MSD 44 (I-2099 Change Over \$89)

FACTORY AUTHORIZED DEALER



Pro Mags 12, 20 & 44
Now in Stock!

Scan for
Pricing &
Details



Same Day, Low Cost
Fast Worldwide Shipping!

www.DragParts.com

Sealed Battery Box

Fits Standard Group 24 battery. NHRA & IHRA Approved. Measures 10.5 x 13 x 9.5" tall. Completely sealed lid. Vent tube to carry battery gases outside of vehicle. Rotational molded plastic case is resistant to battery acid.



JAZ-700-500-01 \$ 87



Mounting brackets and all hardware included!

Stainless-Steel Battery Mount

NHRA & IHRA Legal



Lightweight
Polished SS

ACC-3100 Universal Mount **\$ 32**
ACC-3103 Optima Yellow Top **\$ 55**
ACC-3104 Optima Blue Top **\$ 59**
ACC-3105 Optima Red Top **\$ 58**

Mounting Hardware Included!

Funnels & Filters



JAZ funnels feature anti-splash lips. Can be cut to desired length & flow rate. 11 & 14" accepts 60 Micron Stainless Steel Filter.

8" Round **\$ 16.99**
11" Round **\$ 24.99**
14" Triangular **\$ 16.99**
Filter 60 Micron **\$ 22.99**

Krank Kase

Prevents journal damage. Great for transporting/storing those expensive crankshafts. Strong enough for shipping.



JAZ-700-300-07 SBC
JAZ-700-301-11 BBC

\$ 69



Aluminum Fuel Cells **NEW!**



JAZ's Alum Drag Race cells are made up of 5051 aluminum and Tig welded. Has two anodized AN8 fast-flow outlet fittings in the sump, one AN8 return fitting with Anti-Aeration tube and one AN8 tip-over valve vent fitting. Features an aircraft style, flush mount cap assembly and aviation safety foam.

Optional Cap



JAZ-210-503-03 3Gal \$ 194 **JAZ-210-504-03 4Gal \$ 205**

Head Kase



JAZ storage cases are designed to house a complete cylinder head with studs and springs in a clean and safe environment. Great for shipping.

JAZ-700-200-07 SBC \$ 77.99 ea
JAZ-700-201-11 BBC \$ 84.99 ea

Third Member Storage Case



Keeps third member free of dirt. Fits all Ford 9" and are stackable. Built-in handles makes for easy handling. Great for shipping and storage.

JAZ-700-009-01 Horizontal \$ 54.99
JAZ-700-010-01 Vertical \$ 58.99

Torque-Totes



Torque-Totes are designed to house an 8 to 11" torque converter in a dry and clean environment. Torque-Totes can also be used as shipping containers.

JAZ-700-100-07 \$ 58



Breather Tanks



This remote 1qt breather/ oil separator easily mounts to a rollbar or firewall. Comes standard with molded-in inserts and a swivel petcock for easy draining.



- JAZ-605-025 AN6 **\$ 48.99**
- JAZ-605-825 AN8 **\$ 49.99**
- JAZ-605-125 AN10 **\$ 54.99**
- JAZ-605-225 AN12 **\$ 64.99**
- JAZ-605-001 Blank **\$ 33.99**

Mini Breathers **\$ 65**

Jr Dragsters, Go Carts & Small CID Engines

Similar to above breathers but is 1 pint and has two 3/8 or 1/4 hose barbs.

JAZ-605-375



Radiator Overflow Catch-Cans

One-piece molded construction with swivel elbow input. Lever petcock for easy draining. Meets NHRA rules for 1qt. capacity. Easy mounting with threaded inserts.

JAZ-600-025

\$ 22



Stainless-Steel Overflow

High Luster SS w/ Mounting Bracket

2pt Capacity

- ACC-3120 2 x 19" **\$ 39**
- ACC-3122 3 x 10"

Fuel Cell Tip-Over Valve **\$25**

Fuel cell vent prevents fuel spill if tipped upside-down.

- JAZ-834-006 AN6
- JAZ-834-008 AN8



Pro Mod Fuel Cell

This new **8 gallon** Pro Mod Fuel Cell measures 14"x17" and is 10-1/4" tall at the rear. Its unique shape is well suited to front mount applications. It also features an aircraft style cap assembly and is **certified**.



SFI 28.1

This fuel cell comes standard with:
 -Two AN-12 Fast Flow outlet Fittings
 -One AN-8 Tip-Over Valve Vent
 -Two AN-8 Return lines with an anti-aeration tube attached.

- W/ Cap & Fittings **\$398**
- W/ Cap Only (non-sfi) ... **\$199**

Funny Car/ Altered Cell

Optional Cap

Specially designed with one AN12 pickup (optional AN16). Has one AN6 on top for venting. Multiple fuel injection lines can be easily installed near the top of this cell.



JAZ-290-112-01 12 Gal **\$196**

Small Fuel Cells



Cells are designed for applications utilizing gas & alcohol fuel. The 1 gallon features an aircraft style cap, 1/4" petcock fitting for fuel pickup and vent.



- JAZ-230-025-01 1 Quart **\$ 48.99**
- JAZ-230-051-01 2 Quart **\$ 63.99**
- JAZ-230-001-01 1 Gallon **\$ 126.99**

Poly Fuel Cells



In Stock: 1- 32 Gallons

**Same Day, Low Cost
Fast Worldwide Shipping!**

www.DragParts.com

Milodon is a name you can trust your oil needs to. Their quality products have been keeping race cars lubed for decades. A great value in Oil Systems.

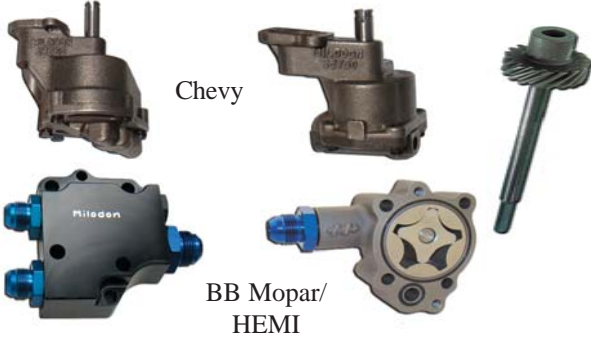

Oil Pumps

MIL-18750 SBC Cast Alum w/ 5/8" Pickup Hole	\$ 56
MIL-18760 BBC Cast Alum w/ 3/4" Pickup Hole	\$ 69
MIL-21815 BB Mopar/Hemi Wet Sump 19gpm AN12	\$ 211
MIL-21225 BB Mopar/Hemi Oil Pump Cover Remote mount	\$ 214
MIL-21503 BB Mopar/Hemi Oil Pump Drive w/ Steel Gear	\$ 123
MIL-21523 BB Mopar /Hemi Oil Pump Drive w/ Bronze Gear	\$ 133



Oil Pans

*Lightweight Steel, Semi-Circular Windage Tray,
Trap Doors, Fits Large Stroke Engines*

MIL-31170 SBC 79 and Earlier Race 7qt Plus Filter	\$ 487
MIL-31176 BBC Mark IV Race Full Kick Out 8qt Plus Filter	\$ 489
MIL-31151 Chrysler BB/Hemi Race 7qt Plus Filter	\$ 415
MIL-31482 Ford 351C Race 8qt Plus Filter	\$ 473
MIL-31488 Ford 429-460 Race 9qt Plus Filter	\$ 547



Pick Ups

MIL-18315 SBC 5/8 Pickup for 31170 Oil Pan	\$ 46
MIL-18202 BBC 3/4 Pickup for 31176 Oil Pan	\$ 59
MIL-21330 Chrys BB/Hemi Pickup AN12 for 31151 Oil Pan	\$ 129
MIL-18570 Ford 351C Pickup for 31482 Oil Pan	\$ 83
MIL-18577 Ford 429-460 Pickup for 31488 Oil Pan	\$ 83



Dan Olson = For Those That Demand and Require High Quality, Aluminum Oil Pans.



O-1240 **BBC** Aluminum Tapered w/ Pickup ... \$ 782



3/8" Billet Rail w/ O-ring, Baffled Windage Tray, Front & Rear Skid Plates.

O-1210 Wet Sump **TFX** w/ Pickup \$ 719

O-1212 Wet Sump **BAE & KB** w/ Pickup \$ 719

HEMI Single AN16 Pickup (AN20 Fitting Available)



Oil Pumps and Filters for Severe Race Applications, especially Blown Alcohol & Top Fuel



Chevy Oil Pumps

Cast Housing
Adjustable Pressure 75-125psi
Bypass Oil Anti-aeration
Use Stock Chevy Pickup
Finest Cast Pump on the Market

SYS-234-900775-2 SB Chevy **\$198**
SYS-234-900773-2 BB Chevy



HEMI Oil Pumps

Billet 7075-T6 Alum Construction
Low Weight & High Strength
Adjustable Oil Pressure 80-250psi
Bypass Oil Anti-Aeration
1.8 Gear 30 GPM!

SYS-235-900780-2 Wet Sump HEMI **\$ 946**
SYS-235-900778-2 Dry Sump w/ Scavenge **\$1849**

Used by 8 out of 10 Professionals!



Spin On



Professional Oil Filters

Spin-On aluminum filter features a re-usable Stainless Steel element. Very easy to inspect oil.

- a. **SYS-209-312361** Oil Filter 4.25" **\$ 156**
- a. **SYS-211-510571** Oil Filter 6.37" **\$ 189**
- b. Replacement SS Element 6.375" **\$ 64**
- c. **SYS-201-203700** Inline Oil Filter **\$ 125**
- d. **SYS-221-90004** Remote Mount **\$ 154**
- e. **SYS-220-90006** Remote 1.50" **\$ 179**
- f. **SYS-222-90007** Side Remote **\$ 163**
- g. **SYS-228-90556** Block Adapter **\$ 179**
- h. **SYS-804-75** Diesel Oil Filter **\$ 499**
- i. **SYS-219-0950** Strap Wrench **\$ 25**
- j. O-Rings Regular **\$ 12** Viton **\$16**

**Remote
Mounts**



Machined from Billet Aluminum and Anodized. **Sizes: AN10 or AN12.**

Block Adapter



Diesel



Over 90% of Nostalgia Funny Cars & Dragsters run System 1 Filters.

Same Day, Low Cost
 Fast Worldwide Shipping!

www.DragParts.com

Check Your Filter Without Opening it!

Simply look through the glass window for any foreign debris. No need to open filter. **HUGE Time Saver!**



a.

Clearview Oil Filters

- * 6061-T6 Billet Aluminum
- * Clear Anodized for Durability
- * Heat Resistant Sight Window
- * Stainless-Steel Cleanable Filter
- * Patented. * 4 or 6" Diameter



b.

- a. **O-3060** 6in Hi-Flow. AN12 Fem Ports up to 70wt Oil **\$ 483**
 b. **O-3062** 6in Screw-On. AN12 Fem Ports up to 70wt Oil. Accepts 1 1/2 - 12 thread **\$ 483**
 b. **O-3042** 4in Screw-On. AN12 Fem Ports up to 50 wt Oil. Accepts GM thread **\$ 386**

See How It Works!

Components & Mounting Brackets



Stainless-Steel Filters

- O-3014-60** Micron 4" **\$ 33**
O-3014-115 Micron 4" **\$ 33**
O-3016-60 Micron 6" **\$ 37**
O-3016-115 Micron 6" **\$ 37**



Viton O-Rings

- O-3004** 4" Viton
O-3006 6" Viton
\$ 10



- Sight Glass**
 4" **\$19**
 6" **\$24**



BILLET Bracket Assemblies Include Mounting Hardware!

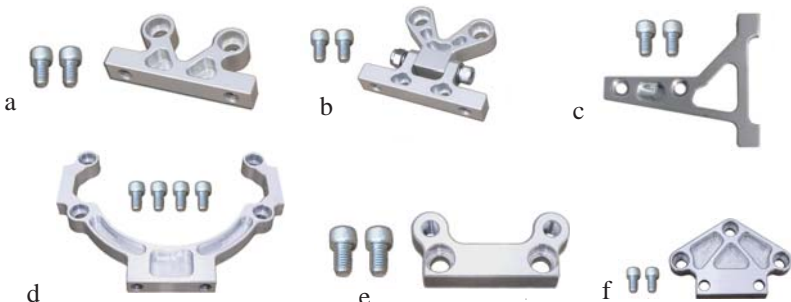

- a **O-3020** 4" Mounting Bracket - Flat Surface **\$ 13**
 b **O-3022** 4" Mounting Bracket - Angle Surface **\$ 19**
 c **O-3024** 4" Bellhousing Mounting - Chevy **\$ 24**
 d **O-3030** 6" Mounting Bracket 2" C-C **\$ 24**
The following mounts to O-3030 Bracket...
 e **O-3032** 6" Oberg Pattern Bracket. 2.375 C-C **\$ 10**
 e **O-3034** 6" CEBE Bracket. 2.600 C-C **\$ 10**
 f **O-3031** 6" Petterson Pattern Bracket. 3-Bolt. **\$ 17**

BILLET Block Adapters

Block Adapters are machined from 6061-T6 billet aluminum and will adapt where the stock disposable filters normally mount. Designed for high-flow without restrictions and are threaded for female AN12 O-ring



- O-3070** Chevy
O-3072 Ford & Dodge
O-3074 Pontiac & Olds
\$ 121.99



Pete Mauriello - Whittier Calif.



Next Event
Mar 2-5, 2017

The *Good Vibrations Motorsports March Meet* is a historic race held annually at the famous Auto Club Famoso Raceway in Bakersfield, California. It draws racers and fans from around the world especially Australia, United Kingdom, Europe and Canada.

A Bucket-List event!



\$15

Here's an Exclusive!

Good Vibrations Motorsports
MARCH MEET Shirt

Silkscreened 11 Colors!

100% Pre-shrunk USA Cotton
Sizes: *Small-3XL*

Check out Race
Results, Pictures
and Videos &
More Online!



Limited Edition Tee Shirts !!



Good Vibrations (Rear)
Enderle (Front)



Silkscreened 6 Colors
100% Pre-shrunk
USA Cotton
Small-3XL

\$12



Hats w/ Class

Go out in style
with a Good
Vibrations
Silkscreened
Trucker or
High Quality
Embroidered
Flatbill.



Silkscreened
*Trucker
Style*
GV-P1004
\$11.99

Embroidered
Flat-Bill
GV-P1007 s-m
GV-P1008 1-xl
\$19.99

**Heavy Duty
Shop Aprons**

2 Large Pockets
Embroidered
Loop Neck
Tie Back

\$19



Our Mission:

At Dragparts.com, we strive to provide high quality performance products at discount prices without sacrificing customer service.

Good Vibrations

8858 Painter Ave, Suite E
Whittier, CA 90602

New Racing Products Free Technical Advice
Used Racing Products Online How-To-Videos

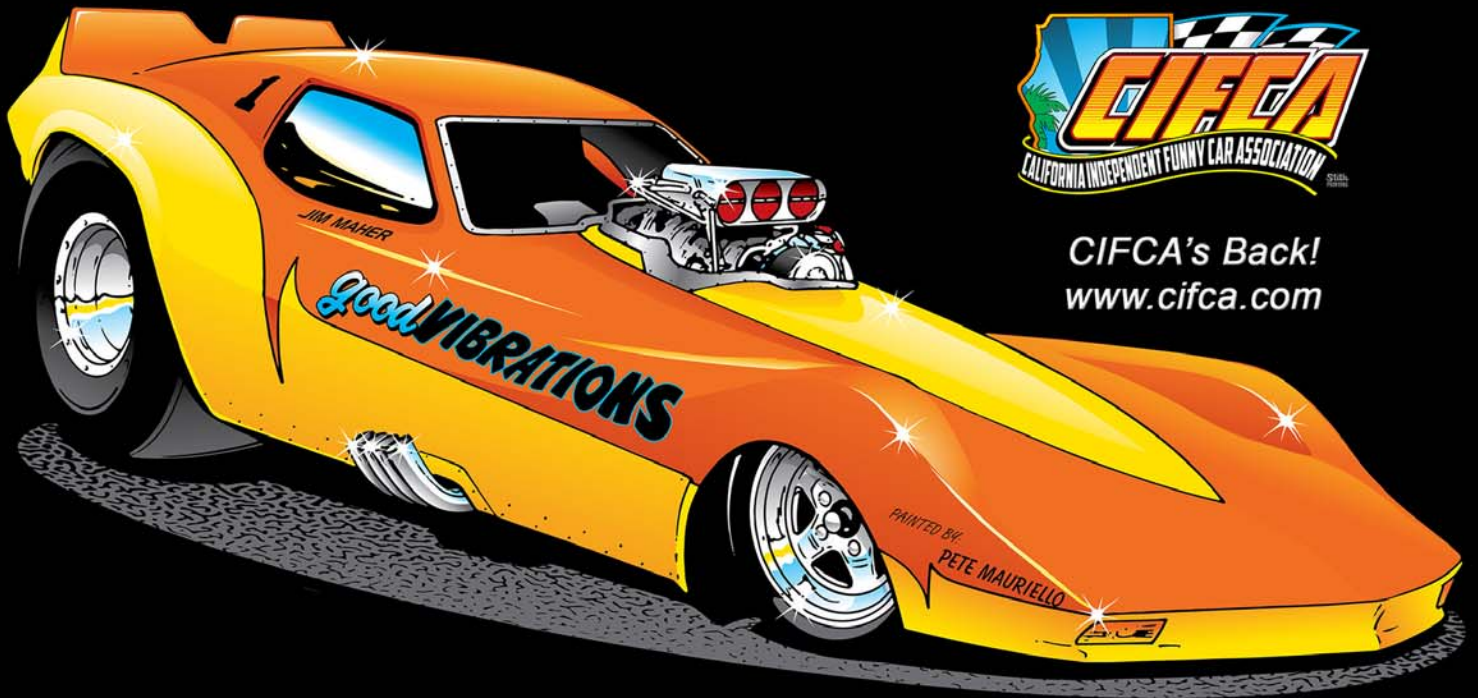

CIFCA's Back!
www.cifca.com

From mild street rods to blown alky racing, we speak your language!



GoodVibrationsRacing.com

New & Preowned Performance Products

Toll Free (800) 576-7661

Online 24/7