

2012-2013

DragParts.com



Good
VIBRATIONS
MOTORSPORTS



Specializing in
Blown Applications



Toll Free 800.576.7661



Mission Statement

Equipping Racers Since Since 1985

At Good Vibrations Motorsports we strive to provide high quality performance products at discount prices without sacrificing customer service.

<p>Fuel Injection</p>  <p>Pages 3-9</p>	<p>Injection Components</p>  <p>Pages 6-7</p>	<p>Linkage Kits</p>  <p>Page 10</p>
<p>Cables/ Brackets</p>  <p>Page 11</p>	<p>Blowers</p>  <p>Page 12</p>	<p>Pulleys & Belts</p>  <p>Page 14</p>
<p>Blower Parts</p>  <p>Pages 15-21</p>	<p>Starters</p>  <p>Page 22</p>	<p>Valve Covers</p>  <p>Page 23</p>
<p>Rings & Bearings</p>  <p>Page 26</p>	<p>Parachutes</p>  <p>Page 29</p>	<p>Driver Safety</p>  <p>Pages 30-31</p>
<p>Specialty Tools</p>  <p>Pages 32-33</p>	<p>Tabs & Brackets</p>  <p>Page 35</p>	<p>AN Hose & Fittings</p>  <p>Pages 36-41</p>
<p>Copper Gaskets</p>  <p>Page 44</p>	<p>Gear Drives</p>  <p>Page 45</p>	<p>Racing Oil & Lubricants</p>  <p>Pages 46-47</p>
<p>Instant \$10 off First Web Order! Coupon Code: 8999</p>	<p>Magneto & Pump Front Drives</p>  <p>Page 48-49</p>	<p>Cool Stuff</p>  <p>Page 50</p>

Blower Injectors



All blower injectors are complete with: Barrel Valve, Fuel Lines, Nozzles & Bodies, Check Valve, Distribution Block & Bypass Pills.

All Injector Assemblies are set up FREE per customer application !

Blown	E-1002 Bugcatcher	\$ 1098
Alky	E-1004 Birdcatcher	\$ 1279

Blown	E-1001 Bugcatcher	\$ 1199
Gas	E-1003 Birdcatcher	\$ 1349

Injector Hat - Partial

Includes:

Polished Hat, Shaft, Stops, Double Arms and Butterflies.



E-4005 Bug **\$ 529** E-4006 Bird **\$ 689**

3-Rib Nostalgia Bugcatcher



It's Back! This injector is nearly identical to the original Bugcatcher of days gone by. Has the three ribs on the top rear. Ideal for that nostalgia look.



E-4005F Finned Bugcatcher **\$ 579**

Big & Ugly Injector

4 Butterfly Sizes: 3 9/16, 4 3/8, 5 & 5 9/16"

This tall aluminum injector hat is Enderle's replica of the carbon fiber hats. It has a highly luster polished finish and billet front.

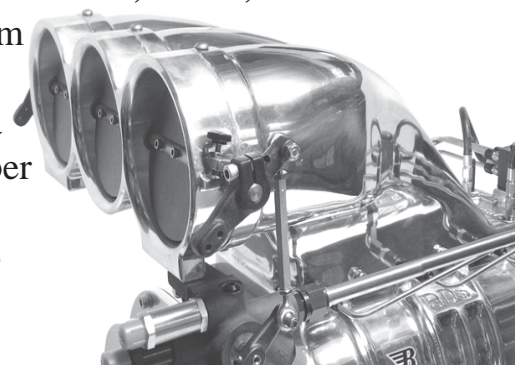

Complete Assembly

E-BAU-3-36 3 9/16 Flies **\$ 1799**

E-BAU-3 4 3/8 B-Flies

E-BAU-1-5 5 B-Flies **\$ 1999**

E-BAU-1 5 9/16 B-Flies

Specs

Weight ... 16lbs

Tall ... 10.5"

Optional

Short ... 8.3"



Partial Hats

E-BAU-3-SB-36 3 9/16" **\$ 1099**

E-BAU-3-SB 4 3/8" **\$ 1099**

E-BAU-1-SB-5 5" **\$ 1399**

E-BAU-1-SB 5 9/16" **\$ 1339**

Includes:

Polished Hat,
Shaft,
Butterflies,
Stops & Arms.

Progressive Linkages

Allows better partial throttle by opening just one butterfly first; The other butterflies are then opened progressively.

E-BAUPLA Installed on new hat **\$ 215**

E-BAUPL1 Retrofit existing hat **\$ 319**

3-Hole Upright Injectors

Ideal for:

Tractor Pullers
Mud Buggers



E-1013A with Filters **\$1449**

E-1014A w/o Filters **\$1249**



Fuel Injection⁴

Same Day Shipping!

800/576-7661

Why Enderle Mechanical Fuel Injection ???

- * *Consistent & Responsive*
- * *Dependable & Affordable*
- * *FREE Tech Support*
- * *Look Cool!*

- E-2100A Bugcatcher \$ 1199
- E-2101A Birdcatcher \$ 1379
- E-7070 Edelbrock SBC TR Base ... \$ 379
- E-7075 Edelbrock BBC TR Base ... \$ 437
- E-6209 Dart BBC Tall Deck w/ Adap \$ 829
- E-460BT Blue Thunder BBF Base .. \$ 629
- E-TRA7075 BBC Top Adap Plate .. \$ 148
- E-SBTRA SBC Top Adap Plate \$ 148

*Injectors are set up per customer application
FREE at NO additional charge.*

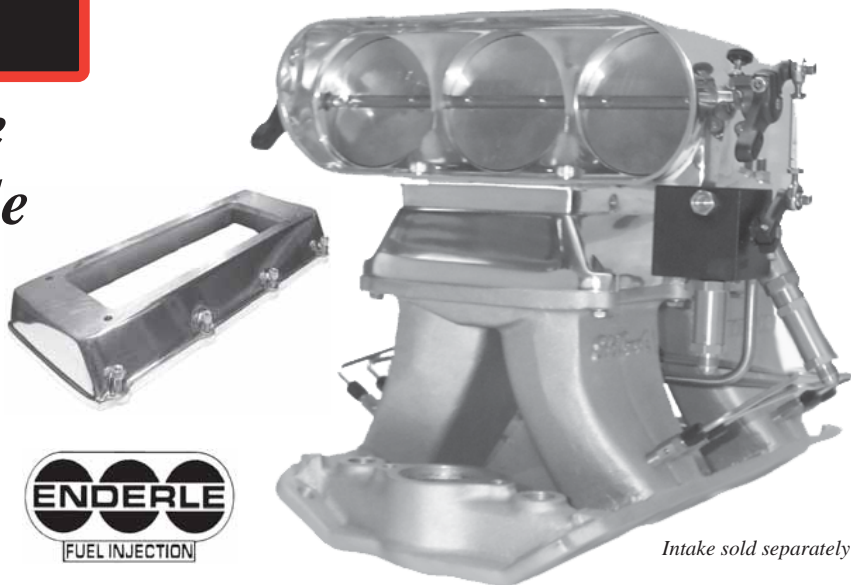

Intake sold separately



All Tunnel Ram Injectors are complete with:

Barrel Valve, Fuel Lines, Nozzles & Bodies, Main and Secondary Check Valves, Dist Block & Bypass Pills.

Convert Your 4 Barrel Manifold into Fuel Injection!

Very Consistent & Responsive

Injectors complete with: Barrel Valve, Lines, Nozzles, Pills and Air Filter Bracket. Has standard Holley four barrel bolt pattern. **Gas or Alky.**

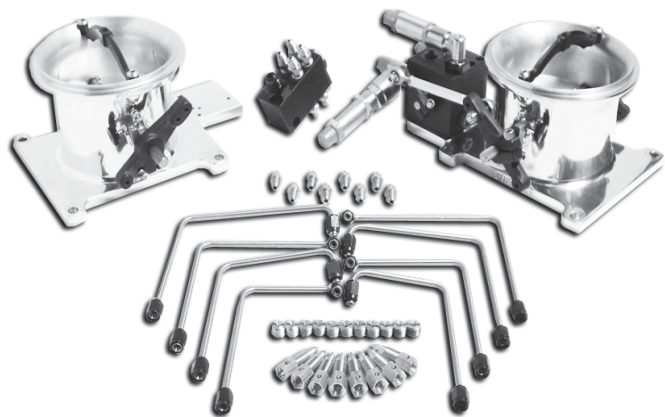

Single/Dual Butterfly Injector

FREE Setup and Calibration per your Application!

Single Body - Assy

E-2020.39 4" \$ 989

E-2020.50 5" \$ 999

Dual Body - Assy

E-2030.39 4" \$1249

E-2030.50 5" \$1349

Single Body - Partial

E-4080.39 4" \$ 349

E-4080.50 5" \$ 389

Air Filter Assembly

E-2020.39F 4" \$ 189

E-2020.50F 5" \$ 207

Progressive Linkage

E-67260SB \$ 55

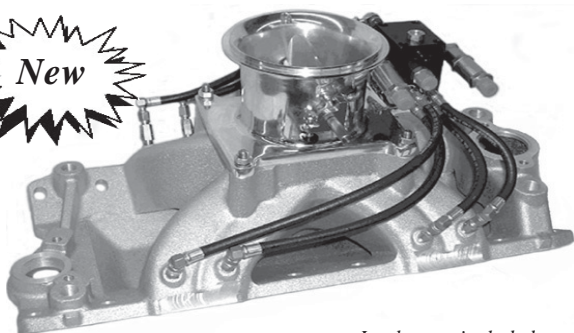

Intake not included

K&N Filter





Stainless Steel Pump Loop Lines

Pre-bent stainless steel loop lines are designed to return fuel to inlet of pump.

- E-110HS6 110 High Speed
- E-110SO6 110 Shutoff
- E-110SOT6 110 Shutoff using a tee (shown)
- E-80AHS6 80A High Speed
- E-80ASO6 80A Shutoff
- E-80ASOT6 80A Shutoff using a tee
- E-LOOP-AN6 AN6 K-style B/V (shown)

Most \$23
Line Only



Complete Loop Kits: \$69 to \$79

Pump Inlet Fitting with Returns

Return fuel lines to the inlet of pump. Available for most fuel pumps. \$39



Routes three AN6 returns into one outlet. Mounts to the side of Shutoff Valve. Accepts "Screw-In" style bypass pills.

Fuel Log

FI-2100 \$99



Pump Belt Drive

Belt drive kits allow one to drive the fuel pump off the crankshaft. Required if your water pump blocks access to the cam.



- E-5011 SBC
- E-5010 BBC
- E-5012 SBF
- E-5014 BB Mopar
- E-5014A Blown
- E-5015 BBF

from \$259

Flowed Fuel Pumps

Pumps are Coated Inside Cam or Belt Driven



- E-3002 80A-0 (4.5 gpm) \$ 479
- E-3003 80A-1 (7.1 gpm) \$ 479
- E-3003.DSR 80A-1 (7.5) \$ 539
- E-3004A 600 (9.2 gpm) \$ 529
- E-3004 110 (13.4 gpm) \$ 529
- E-3005 990 (15.7 gpm) \$ 629
- E-3006 1100 (17.2 gpm) \$ 649
- E-3008 1270 (20.2 gpm) \$ 719

- E-2000C 3-Hole Collar \$ 39
- E-3000C 4-Hole Collar \$ 54
- E-88011 11mm Bearing \$ 13
- E-6002.ZZ 15mm Brng \$ 13
- E-114HC-11 .433 Seal \$ 23
- E-114HC-15 .590 Seal \$ 23

Fuel Pump Exts



- * 3pc Billet Aluminum
- * 360 Degrees Adjustable
- * Internal Shaft & Bearing

Lengths: 2 - 6 inches (1/2" inc.)

Standard Ext From \$ 120

Quick Release From \$ 148

QR SS Clamp \$ 45

3-Way Fuel Shutoff Valve

Adjustable 360 Degrees
Includes Arm & Fittings

Mandatory on Enderle pumps

Shutoff Valve

E-85110 AN6 \$ 84

E-85210 AN8 \$ 109

E-85310.12 AN12 ... \$ 154

O-Ring/ Seal Kit

E-85103 AN6 \$13

E-85203 AN8 \$13

S/O Bracket Kit

E-80ABR 80A Pumps \$33

E-110BR 110 Series \$33

Over-Center Spring Bracket Assy

This bracket setup will hold the Enderle shutoff valve positively in the ON position until it is turned off manually.

Includes: Billet Alum Bracket, SS Spring, Bolt & Nut.

FI-5140 AN6 S/O

FI-5142 AN8 S/O



New

\$39

Same Day Shipping!

800/576-7661

Injector Hat Spacer



Billet Adapter

Allows one to bolt a smaller hat (13.25" bolt pattern) to a large blower (15.25" bolt pattern).

- E-BS2 2in Injector Spacer **\$ 89**
- E-BS3 3in Injector Spacer **\$ 94**
- B-9055 Billet Hat Adapter **\$169**



Polished Spacers

Height: 2 or 3"
C-C: 13.25"
Includes Hardware

Hi-Flow Adapter



Machined from billet aluminum & o-ringed. Accepts Enderle or Hilborn hats & carb adapter plates. 2" high & 3" forward offset for improved airflow.

- B-9058 Polished **\$ 398**
- B-9059 Anodized Black

Injector Hat Filter Assy

Keeps rocks and debris out of your engine & blower.

Sand Drags * Mud Bogs Tractor Pullers

Kit includes:

- Outerware
- Billet Aluminum Housing
- SS Quick Disconnect Pins
- Mounting Hardware
- Reusable Filter element



Bugcatcher	\$ 375
Birdcatcher	\$ 375
Filter Only	\$ 89
SS QR Pin	\$ 25
Big & Ugly	\$ 395
Filter Only	\$ 99

Outerware: (Red, Orange, Blue, Black, Purple) **\$26**

Bypass Pills, Nozzle Jets, Holders

Enderle **Bypass Pills** are the Screw-In style and are designed to divert fuel away from the engine. The larger the pill, the leaner the mixture.



Install pills without damaging. Stores 8 pills.

E-7009.SD Driver **\$35.99**



Sizes:

.020 to .209

E-7009 Bypass Pill **\$3.19**



Hi-Speed kit .050-.095 **\$31.99**



Alum storage holder is a convenient place to store up to 40 bypass pills.

E-7010 Pill Holder **\$19.99**

Enderle **Nozzle Jets** are the "Screw-In" style



Anodized aluminum storage holder is a convenient and safe place to store up to 60 jets.



Sizes: .016 to .110

- a. E-7007 Brass Nozzle Jet **\$ 4.75**
- a. E-7007A Flowed Nozzle Jet **\$ 6.99**
- b. E-7121A Port Nozzle Body **\$ 9.99**
- b. E-7130A Ball Check Port Body **\$ 16.99**
- c. E-7110A Top Nozzle Body **\$ 9.99**
- d. E-7011 Jet Storage Holder **\$ 21.99**

On-Board Primer System

Special 4psi check valve controls fuel. **Choice:** Stainless-Steel or 1qt Poly tank. Prime mechanical fuel injection from inside the driver's cockpit.

Kit Includes
SS Fuel Cell 1/2 qt
Primer Check Valve
5' Braided SS Hose
Hose Fittings



\$99

* Electric Pump Required

Quality Fuel Injection Components



- | | |
|---|-------|
| E-4013 Bugcatcher Butterfly | \$ 12 |
| E-4014 Birdcatcher Butterfly | \$ 18 |
| E-4103 Buzzard Butterfly | \$ 21 |
| E-4103CF Big/ Ugly Butterfly | \$ 23 |
| E-4011 Small serrated arm | \$ 8 |
| E-4011A-5/16 Double serrated arm Bug | \$ 16 |
| E-4011A Double serrated arm Bird/Buzz/ BAU | \$ 16 |
| E-4011B Long double serrated arm Bird/Buzz | \$ 17 |
| E-4012-5/16 Throttle stop Bug | \$ 10 |
| E-4012 Throttle stop Bird/Buzz/ BAU | \$ 10 |
| E-4012TS Throttle stop thumb screw | \$ 2 |
| E-4026 Barrel Valve Linkage Turnbuckle Assy | \$ 17 |

Butterfly Colors
Black, Red, Blue,
Purple, Plain



- | | |
|--|--------|
| E-5001 SB Chevy Alum Front Cover | \$ 107 |
| E-5002 SB Chevy Front Cover Seal | \$ 14 |
| E-5003 SB Ford Alum Front Cover | \$ 107 |
| E-5004 BB Chevy Alum Front Cover | \$ 107 |
| E-5008 Chevy Hex Drive Assembly | \$ 46 |
| E-4009 Bugcatcher Shaft | \$ 79 |
| E-4010 Birdcatcher Shaft | \$ 99 |
| E-4102 Buzzardcatcher Shaft | \$ 112 |
| E-4102CF Big & Ugly Shaft | \$ 118 |
| B-5019 Hat Injector Stud & Nut Kit (4pc) | \$ 11 |

Distribution Blocks

Distribution Blocks feature a black billet alum housing and includes fittings. Machined for use with a primer check valve.

- | | |
|---|-------|
| E-4027 Hat Dist Block w/ 8 fittings | \$ 65 |
| E-4027A Hat Dist Block w/ 12 fittings | \$ 77 |
| E-4027VW Port Dist Block w/ 4 fittings | \$ 34 |
| E-4028 Port Dist Block w/ 8 fittings | \$ 58 |



Injector Hat & Ports Line Sets



Assembled Line Sets (Set of 8)

- | | |
|--|--------|
| E-4031 Hat SS | \$ 110 |
| E-4034 Hat Rubber | \$ 110 |
| E-4036 Port SS | \$ 191 |
| Rubber or Stainless Steel E-4035 Port Rubber | \$ 114 |

Port Line Kit

\$ 369



Complete with:

Nozzle Jets and Bodies, SS Lines (or hoses), Dist Block & AN8 Check Valve.



Available with Rubber Hoses .. \$ 339

Need a Tune up? Call or email us - No Charge!

Billet Y-Blocks



Gas,
Alky
Nitro

Billet Aluminum
Black Anodized
Single Inlet
Dual Outlets
Fuel or Oil

\$55

FI-2110 AN8-6 FI-2112 AN10-8 FI-2116 AN12-10

Check Valves



Brass check valves feature a one-way, spring-loaded poppet design. PSI is varied by springs and shims.

- | | |
|------------------------|-------|
| AN6 Check Valves | \$ 38 |
| AN8 Check Valves | \$ 55 |
| Primer Check Valve AN4 | \$ 21 |
| AN6 Spring & Shim Kit | \$ 19 |

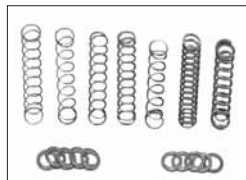

Barrel Valves

Enderle Barrel Valves can be used on Gas, Alky or Nitro.
Available for Blowers & Tunnel Rams.



- E-MVORM O-Ring Kit (Specify Style) \$ 10
- E-4018 Gas Metering Piston \$ 69
- E-4018-32 Tunnel Ram Metering Piston ... \$ 69
- E-4019 Alcohol Metering Piston \$ 69
- E-4020 Nitro Metering Piston K-Style \$ 83
- E-4020A Alky Metering Piston K-Style \$ 83
- E-4023 Barrel Valve Assy Square-Style Alky \$ 269
- E-4024A Barrel Valve Assy K-Style Alky \$ 289

Barrel Valve Leakdown

- * Block off all injector lines & returns except for hat nozzles
- * Connect dual gauge tester to outlet of compressor
- * Set air compressor to read 100psi on 1st gauge
- * Connect tester to inlet of barrel valve
- * Read % on 2nd gauge
- * Adjust linkage turnbuckle for desired %
(Lengthen to Richen, Shorten to Lean)



How to Video

Leakdown Tester

Professional Grade

Dual Gauge w/ 14mm
Cylinder Hose

\$ 109
T-2002



Injector Hose \$19

T-2006 AN6 T-2008 AN8

12V Electronic Fuel Lean-outs



- * More Top End MPH
- * Accepts Enderle Pills
- * Converter Helper
- * Low Draw



FI-5100 Leanout FI-5102 Enrichment **\$199**



As a high-speed lean out, this valve can be activated with an RPM activated switch, timer or momentary switch. Fuel will be taken away at the top end for best horsepower. What's a "Converter helper"? When a fuel injected motor is on a rev limiter, the motor cools down severely since a large quantity of fuel is not being burned. This valve can be wired to the transbrake circuit so that when the transbrake is set, the valve opens and keeps the motor hot, lean and mean while on the rev limiter.

Toll-Free Tech Advice &
Online "How-To-Videos"

800/576-7661

DragParts.com



Hi-Speed Assembly

- Bleeds off fuel at higher rpm.
- Frees up top-end horsepower.
- Install anywhere between pump and distribution block.
- Variety of Pressures Available.
- Accepts Enderle Bypass Pill.



\$69

E-7019 Unblown AN6 T E-7018 Blown AN8 T



Premium Fuel Filters

System One filters are made from billet alum and feature a reusable 30 micron SS filter. Handles high pressure without volume loss.

- | | | |
|--|---------------------------------|--------------------------------------|
| Race - Long 2 x 9" \$144 | Race 2 x 6" \$119 | Pro-Street 2 x 4" \$94 |
| AN6 SYS-202-202406 | SYS-201-203406 | SYS-200-201406 |
| AN8 SYS-202-202408 | SYS-201-203408 | SYS-200-201408 |
| AN10 SYS-202-202410 | SYS-201-203410 | SYS-200-201410 |
| AN12 SYS-202-202412 | SYS-201-203412 | <i>Gas, Alky & Nitro</i> |



JAZ inline billet aluminum *filters* are 5in long and feature a 35 micron element.

Gas Only \$39

- JAZ-836-006-11 AN6
- JAZ-836-008-11 AN8
- JAZ-836-010-11 AN10
- JAZ-836-001-11 3/8" Barb



Fuel Filters

Designed to mount before the pump. AN12 female ports and a reusable #40 stainless steel screen. Foot pad is tapped with 1/4 -20 threads for easy mounting.



E-4056 .. \$62

Filter-Shutoff



Same as E-4056 but with a built-in 2 way shutoff valve for easy maintenance of fuel system.

E-4057 .. \$89



Gas, Alky & Nitro

AN12 Mounts Inline

Gas or Alky



X-980012FS \$28



Equipping Racers Since 1985 !!

Hydrometers



Kits complete with: Hydrometers, Glass Beaker, Thermometer, Padded Case and Instructions. **Also checks:** Gas, Methanol & Ethanol.

Hydrometer Kits

- T-1203** 0-30 Nitro. 2 Hydrometers **\$ 209**
- T-1204** 0-60 Nitro. 3 Hydrometers **\$ 229**
- T-1205** 0-100 Nitro. 4 Hydrometers .. **\$ 249**

Hydrometer Only

- T-1210** Hydrometer Gas-Methanol **\$ 26**
- T-1213** Hydrometer 5-30% Nitro **\$ 26**
- T-1215** Hydrometer 30-60% Nitro **\$ 26**
- T-1217** Hydrometer 60-100% Nitro **\$ 26**

Components

- T-1220** Padded Case **\$ 89**
- T-1222** Glass Beaker **\$ 39**
- T-1224** Thermometer **\$ 42**

Used by Pros & Sportsmen

Pressure Gauge

Liquid Filled
Boost, Oil, Fuel



1.50" Diameter

Gauge Only \$39

- X-710000** 0-15psi
- X-710030** 0-30psi
- X-710060** 0-60psi
- X-710100** 0-100psi

Blower Boost Memory Kit .. \$ 45
Records Highest Reading
(Gauge not included in kit)

Injector De-Icer

Spray directly onto Injector Butterflies to prevent sticking & freezing.

1lb Aeorsol

FI-7150 .. \$ 7



Testimonial

Hi Kasey,
I purchased a big & ugly set up off you guys in Sept last year. You guys got it right straight away, excellent work & I want to say thanks alot.
Matthew Power -Lightning Ridge, Australia



Injected? Get Connected!



Throttle Cable Bracket

6061 Billet Aluminum
Swingover hookclamp.
Provision for Springs.
Fits most Blower &
Tunnel Ram Injectors.
TF/TA Approved.

\$ 98

FI-5113 Most Hats FI-5114 PSI Hat

Throttle Stop

Quick Release in < 1 Second
Billet Aluminum w/ SS Pin
Top Fuel & Alcohol Legal

FI-5120 **\$ 59**

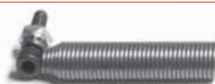
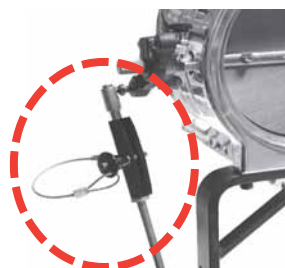

Return Springs

Special bend prevents spring from detaching from
Injector. Includes Grade 8 10-24 bolt & locking nut.

FI-5115 Primary (Strong)
FI-5116 Secondary (Medium)

\$6.99

Injector Hat Linkage Kit

\$ 89



Designed to work with mechanical fuel injection
(Bug or Birdcatcher) on blown applications only.
Adjustable heim end design and needle bearings
for smooth throttle operation. E-76-GVIHL

Blower Mounted Throttle Cable Bracket

Works with Bug or Bird.
Anodized Aluminum.
Mounts to front of Blower.
Swingover Hook clamp.
Provision for Springs. FI-5110

\$ 35



Tunnel Ram Linkage Kits

Everything needed
for mounting **Dual Carbs** on a Tunnel
Ram *Side-Saddle*

\$ 119

- E-72-2000 SBC
- E-71-1000 BBC
- E-75-107 Ford 351C
- E-75-220 Ford 460

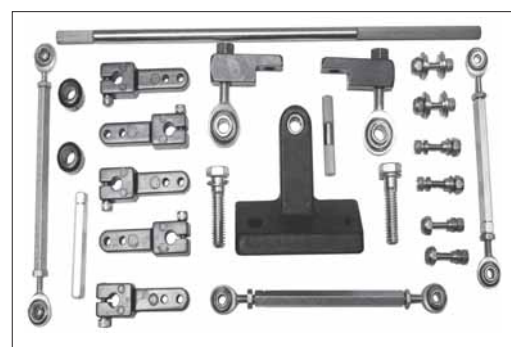

Progressive .. \$ 58

Dual Carbs Inline on a TR

- E-67-260FSB **SB Chevy**
- E-67-260FBB **BB Chevy**

Carb Linkage Kits

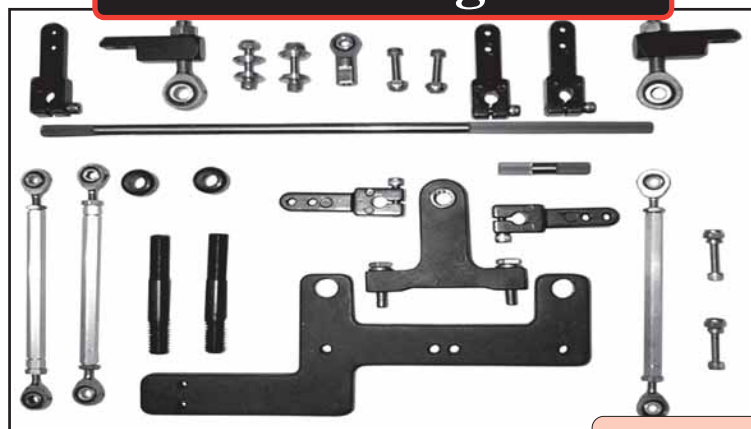

Blower Linkage Kits

\$ 119

For dual Holley double-pumpers, Dominators, Predators & Carters mounted **Side-Saddle**. Includes adjustable heim-end design and needle bearings for smooth throttle operation. E-76-107

For dual Holley vacuum secondary, Dominators, Predators & Carters mounted **Inline** on a 8 9/16 center-to-center distance. Includes adjustable heim-end design and needle bearings for smooth throttle operation. E-55-501



Determine Correct Cable

1. Select The Housing Style
2. Measure the Length (Tip to Tip)

Bulkhead (Threaded)



Groove



Custom Length Cables?
No Problem!

24" Throttle Cable



CC-UV-100-24 Nylon Housing **\$29**

CC-UV-200-24 Stainless Steel **\$39**

* Cables can be shortened *



18'
Chute
Cable

Stainless Steel **CC-PCTG-216 .. \$31**
Center Wire **With Lever .. \$40**

Cable Brackets

Billet Aluminum & Lightweight

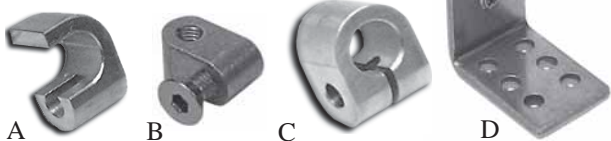

- A. CC-161-011-V Billet Half Clamp **\$7**
- A. CC-161-011-P Billet Chute Clamp **\$7**
- B. CC-091-SP3-A Chute Pivot
- C. CC-161-011-VF Billet Full Clamp **\$9**
- D. CC-161-011-M Swing Hook Clip **\$9**

The Choice of the Pros in Top Fuel & Alcohol

- * Threaded Male 10-32 Both Ends
- * Grooved or Bulkhead Housing
- * Stainless Steel Inner
- * Heavy Duty Quality



Micro-adjust



Call for sizes or check online.

Micro-adjust cables are perfect for any application where a locking cable must be used, such as marine or where high vibration conditions are experienced. Allows the cable to be locked at partial travel and incorporates a push-release button for easy adjustment.

Grooved *Grooved* Housing on Both Ends.
* Throttle

Bulkhead Double-Nut *Bulkhead Housing* on One or Both Ends.
* Shifter

T-Handle *Grooved* Housing on One End. *T-Handle* with Double-Nut *Bulkhead* on Driver's End.
* Fire System, Fuel Shutoff

Length	Groove	Bulkhead	T-Handle
2 Foot (24")	\$ 39.99	\$ 50.99	\$ 62.99
3 Foot (36")	\$ 39.99	\$ 52.99	\$ 61.99
4 Foot (48")	\$ 42.99	\$ 52.99	\$ 65.99
5 Foot (60")	\$ 44.99	\$ 55.99	\$ 67.99
6 Foot (72")	\$ 47.99	\$ 57.99	\$ 69.99
7 Foot (84")	\$ 49.99	\$ 59.99	\$ 72.99
8 Foot (96")	\$ 51.99	\$ 62.99	\$ 74.99
9 Foot (108")	\$ 54.99	\$ 64.99	\$ 77.99
10 Foot (120")	\$ 56.99	\$ 67.99	\$ 79.99
11 Foot (132")	\$ 59.99	\$ 69.99	\$ 81.99
12 Foot (144")	\$ 61.99	\$ 72.99	\$ 84.99
13 Foot (156")	\$ 63.99	\$ 74.99	\$ 86.99
14 Foot (168")	\$ 66.99	\$ 77.99	\$ 89.99

Cable Ends

\$8ea

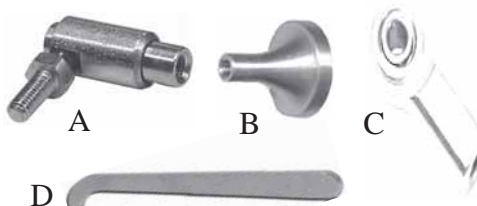

- A. CC-175-403-0030 Q.D. Ball Joint
- B. CC-165-172-307A Round Knob
- C. CC-CREF-3-3 Female Heim
- D. CC-PCH-100 Alum Lever .. \$9

800.576.7661

We pay CASH for your used Fuel Injection Hats and Blowers Parts!

sales@dragparts.com

Billet Case Blowers!



The Blower Shop superchargers are some of the finest on the market. Their BILLET case is superior to cast casings and has a show polished finish.

Proven successful in professional motorsports including: Drags, Marine and Tractor Pulling.

HA = Anodized Rotors/ Case
Race = HA & 18 strips of teflon and case drilled for rear nozzles..

Billet Case/ Cast Rotors

6.71 HA	\$ 2795
6.71 Race	\$ 2995
8.71 HA	\$ 2795
8.71 Race	\$ 2995

Billet Case/ Billet Rotors

6.71 Race	\$ 3895
8.71 Race	\$ 3995
10.71 Race	\$ 3995
14.71 Race	\$ 4195
14.71 Race Hi-Helix	\$ 5495

Show Quality 6.71 to 16.71 Blowers



BDS blowers are hand assembled with competition components.

Special features include: Double lipped teflon seals, heavy-duty bearings, double pinned rotors, sight gauge and Billet bearing plates.
Options: Hard anodizing, teflon strips and front discharge cases.

Many blower companies use reconditioned GM diesel rotors in their blowers. **Air-Loc** are BDS brand NEW cast rotors. Makes more boost at cooler temperature. **Bottom line:** More Horsepower.

BDS **Pro-Loc** are **Billet** rotors; available in standard or hi-helix.

Air-Loc Cast Rotors

6.71 Street-GM	\$ 1595
6.71 Street	\$ 2595
6.71 Race	\$ 3395
8.71 Street	\$ 2595
8.71 Race	\$ 3395

Pro-Loc Billet Rotors

8.71 Pro-Loc	\$ 4345
14.71 Pro-Loc	\$ 4479
14.71 Hi-Helix	\$ 4950

Race style has 18 strips of teflon. Rotors and inside of case are hard anodized.

BDS Blower Kits are some of the finest on the market. Show-Quality & Precision Machined.

Kits Include: Air-Loc Blower, 1 Vee Drive Kit, Dual Carb Adap, Bolts, Gaskets & Warranty!

Kits are Custom Assembled per your Application

SB Chevy 6.71 Kit	\$ 2990
BB Chevy 8.71 Kit	\$ 3690
426 Hemi 8.71 Kit	\$ 3990
460 Ford 8.71 Kit	\$ 4190

Call for Others

Popular Kit Options:

Polish Blower	\$205	Upgrade to 8mm	\$65
Polish Manifold	\$110	Upgrade Stage II Blower	\$239

Street/Strip Blower Kits

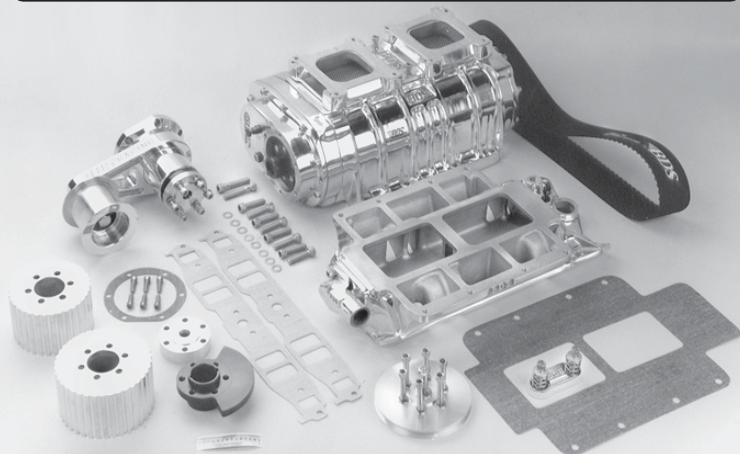



8mm



TOP PULLEY

	43	44	45	46	47	48	49	50	51	52	53	54	55	56
47	9.3	6.8	4.4	2.2	1.0	-2.1	-4.1	-6.0	-7.2	-9.6	-11.3	-13.0	-14.5	-16.1
48	11.6	9.1	6.7	4.3	2.1	1.0	2.0	-4.0	-5.9	-7.7	-9.4	-11.1	-12.7	-14.3
49	14.0	11.4	8.9	6.5	4.3	2.1	1.0	-2.0	-3.9	-5.8	-7.5	-9.3	-10.9	-12.5
50	16.3	13.6	11.1	8.7	6.4	4.2	2.0	1.0	-2.0	-3.8	-5.7	-7.4	-9.4	-10.7
51	18.6	15.9	13.3	10.9	8.5	6.3	4.1	2.0	1.0	-1.9	-3.8	-5.6	-7.3	-8.9
52	20.9	18.2	15.6	13.0	10.6	8.3	6.1	4.0	2.0	1.0	-1.9	-3.7	-5.5	-7.1
53	23.2	20.5	17.8	15.2	12.8	10.4	8.2	6.0	3.9	1.9	1.0	-1.9	-3.6	-5.4
54	25.5	22.7	20.0	17.4	14.9	12.5	10.2	8.0	5.9	3.8	1.9	1.0	-1.8	-3.6
55	27.9	25.0	22.2	19.6	17.0	14.6	12.2	10.0	7.8	5.8	3.8	1.9	1.0	-1.8
56	30.2	27.3	24.4	21.7	19.1	16.7	14.3	12.0	9.8	7.7	5.7	3.7	1.8	1.0
57	32.5	29.5	26.7	23.9	21.3	18.8	16.3	14.0	11.8	9.6	7.5	5.6	3.6	1.8
58	34.8	31.9	28.9	26.1	23.4	20.8	18.4	16.0	13.7	11.5	9.4	7.4	5.5	3.6
59	37.2	34.1	31.3	28.3	25.5	22.9	20.4	18.0	15.7	13.5	11.3	9.3	7.3	5.4
60	39.5	36.4	33.3	30.4	27.7	25.0	22.4	20.0	17.6	15.4	13.2	11.1	9.1	7.1
61	41.8	38.6	35.6	32.6	29.8	27.1	24.5	22.0	19.6	17.3	15.1	13.0	10.9	8.9
62	44.2	40.9	37.8	34.8	31.9	29.2	26.5	24.0	21.6	19.2	17.0	14.8	12.7	10.7
63	46.5	43.2	40.0	37.0	34.0	31.1	28.6	26.0	23.5	21.2	18.9	16.7	14.5	12.5
64	48.8	45.5	42.2	39.1	36.2	33.3	30.6	28.0	25.5	23.1	20.8	18.5	16.4	14.3
65	51.2	47.7	44.4	41.3	38.3	35.4	32.7	30.0	27.5	25.0	22.6	20.4	18.2	16.1
66	53.5	50.0	46.7	43.5	40.4	37.5	34.7	32.0	29.4	26.9	24.5	22.2	20.0	17.9
67	55.8	52.3	48.9	45.6	42.6	39.6	36.7	34.0	31.4	28.8	26.4	24.1	21.8	19.6
68	58.1	54.5	51.1	47.8	44.7	41.7	38.8	36.0	33.3	30.8	28.3	25.9	23.6	21.4
69	60.5	56.8	53.3	50.0	46.8	43.8	40.8	38.0	35.3	32.7	30.2	27.8	25.5	23.2
70	62.8	59.1	55.6	52.2	48.9	45.8	42.9	40.0	37.3	34.6	32.1	29.6	27.3	25.0

BOTTOM PULLEY

Drive Ratio Chart

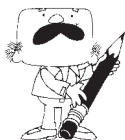

13.9mm/14mm 1/2" Pitch 30-41T



TOP PULLEY

	25	26	27	28	29	30	31	32	33	34	35	36	37
25	1.0	-3.8	-7.4	-10.7	-13.8	-16.7	-19.4	-21.9	-24.2	-26.5	-28.6	-30.6	-32.4
26	4.0	1.0	-3.7	-7.1	-10.3	-13.3	-16.1	-18.7	-21.2	-23.5	-25.7	-27.8	-29.7
27	8.0	3.8	1.0	-3.6	-6.9	-10.0	-12.9	-15.6	-18.2	-20.6	-22.9	-25.0	-27.0
28	12.0	7.7	3.7	1.0	-3.4	-6.7	-9.7	-12.5	-15.2	-17.6	-20.0	-22.2	-24.3
29	16.0	11.5	7.4	3.6	1.0	-3.3	-6.5	-9.4	-12.1	-14.7	-17.1	-19.4	-21.6
30	20.0	15.4	11.1	7.1	3.4	1.0	-3.2	-6.2	-9.1	-11.8	-14.3	-16.7	-18.9
31	24.0	19.2	14.8	10.7	6.9	3.3	1.0	-3.1	-6.1	-8.8	-11.4	-13.9	-16.2
32	28.0	23.1	18.5	14.3	10.3	6.7	3.2	1.0	-3.0	-5.9	-8.6	-11.1	-13.5
33	32.0	26.9	22.2	17.9	13.8	10.0	6.5	3.1	1.0	-2.9	-5.7	-8.3	-10.8
34	36.0	30.8	25.9	21.4	17.2	13.3	9.7	6.3	3.0	1.0	-2.9	-5.6	-8.1
35	40.0	34.6	29.6	25.0	20.7	16.7	12.9	9.4	6.7	2.9	1.0	-2.8	-5.4
36	44.0	38.5	33.3	28.6	24.1	20.0	16.1	12.5	9.1	5.9	2.9	1.0	-2.7
37	48.0	42.3	37.0	32.1	27.6	23.3	19.4	15.6	12.1	8.8	5.7	2.8	1.0
38	52.0	46.2	40.7	35.7	31.0	26.7	22.6	18.8	15.2	11.8	8.6	5.6	2.7
39	56.0	50.0	44.4	39.3	34.5	30.0	25.8	21.9	18.2	14.7	11.4	8.3	5.4
40	60.0	53.8	48.1	42.9	37.9	33.3	29.0	25.0	21.2	17.6	14.3	11.1	8.1
41	64.0	57.7	51.9	46.4	41.4	36.7	32.3	28.1	24.2	20.6	17.1	13.9	10.8
42	68.0	61.5	55.6	50.0	44.8	40.0	35.5	31.3	27.3	23.5	20.0	16.7	13.5
43	72.0	65.4	59.3	53.6	48.3	43.3	38.7	34.4	30.3	26.5	22.9	19.4	16.2
44	76.0	69.2	63.0	57.1	51.7	46.7	41.9	37.5	33.3	29.4	25.7	22.2	18.9
45	80.0	73.1	66.7	60.7	55.2	50.0	45.2	40.6	36.4	32.4	28.6	25.0	21.6

BOTTOM PULLEY

How to select
your Belt &
Pulleys Sizes



Blower Belts



Street/ Race < 35% OD

8mm, 1/2" Pitch

Race > 35% OD

8mmGT, 13.9 & 14mm

Available in
Rubber or
PolyChain/
Carbon (GT)

Belts listed are 3" Wide.

1/2 Pitch



510H300	\$ 69
540H300	\$ 69
550H300	\$ 69
560H300	\$ 69
570H300	\$ 69
585H300	\$ 79
600H300	\$ 79
630H300	\$ 89
660H300	\$ 89
700H300	\$ 89

8mm



1280M75	\$ 109
1360M75	\$ 109
1440M75	\$ 109
1440M75GTC	\$ 169
1512M75GTC	\$ 139
1520M75	\$ 129
1600M75	\$ 129
1696M75	\$ 129
1600M75GTC	\$ 189
1792M75GTCPS	\$ 239

13.9 & 14mm



13.9mm

1543M65	\$ 159
1543M75	\$ 189

14mm

1400M75.....	\$ 299
1568M75GTC	\$ 289
1610M75	\$ 299
1610M75GTC	\$ 289
1694M75	\$ 325
1750M75GTC	\$ 329

Good Vibrations offers one of the largest selection of blower pulleys.

Billet Alum Blower Pulleys

3.5" Wide
2.0" Register



1/2 Pitch

Ratios < 15%
Sizes: 30-41
From \$ 79



8mm

Ratios < 35%
Sizes: 43-70
From \$ 83



8mmGT

Ratios > 35%
Sizes: 43-75
From \$ 96



13.9mm

Ratios > 35%
Sizes: 25-45
From \$ 89



14mm & GT

Ratios > 35%
Sizes: 25-46
From \$ 89

Pulleys are 3.5" wide with a 2" register.

Machined from Billet 6061 aluminum and T-6 heat treated.

Hard anodizing is standard on: 8mmGT, 13.9 and 14mm/ GT pulleys.

V-Groove Pulleys

V-Groove Pulleys are machined from billet 6061-T6 alum. Has a 2" register and bolt directly to crank hub with 6 bolts. Can be stacked together for PS, AC, etc...

Adapter-style pulleys bolt directly to harmonic balancers and are available in single or double V-Grooves. Billet aluminum spacers allow one to easily align both top and lower blower pulleys.



B-2205 Single V-Groove Pulley	\$ 65
B-2211 Single V-Groove Adap SBC	\$ 85
B-2212 Dual V-Groove Adap SBC	\$ 109
B-2221 Single V-Groove Adap BBC	\$ 85
B-2222 Dual V-Groove Adap BBC	\$ 109

Pulley Spacers



.300 - 1.40" widths
from \$ 19

Accessory Pulleys



Billet Aluminum
Uppers are Polished

Fits Short Water Pumps

B-2230 Water Pump SBC	\$ 39.95
B-2233 Water Pump BBC	\$ 39.95
B-2236 Lower Pulley BBC	\$ 29.95
B-2240 Alternator SB Chevy	\$ 29.95
F-312-1000SS SS WP Bolt	\$.75

Blower Manifolds

Standard Features Include:

Raised tented floor for improved airflow.
Solid sides for added strength and rigidity.
Competition models have port nozzle provisions.
Most will accept 6.71 through 14.71 blowers.
Street includes thermo housing and backfire valve.



Chevy Race



426 Hemi



Chevy Street



392 Hemi



440 Mopar

SBC Race

New



* Drilled for Port Nozzles
* Machined for Burst Panel

Ford 429-460



Most Manifolds are in Stock!



BDS-8006-1206 SB Chevy Street ...	\$ 498
B-7100 SB Chevy Race Mooneyham	\$ 448
TBS-2533 SB Chevy Street LG port	\$ 549
TBS-2536 SB Chevy Race LG port	\$ 779
BDS-8026S BB Chevy Street Std	\$ 548
BDS-8026T BB Chevy Street Tall ...	\$ 578
BDS-8027S BB Chevy Race Std	\$ 448
BDS-8027T BB Chevy Race Tall	\$ 498
BDS-8607 Pontiac 326-455	\$ 548
BDS-8386-H Mopar 392 Hemi	\$ 478
BDS-8376 Mopar 426 Hemi	\$ 528
BDS-8366 Mopar 440	\$ 448
BDS-8406 Ford 289-302	\$ 998
BDS-8456 Ford 429-460	\$ 698
BDS-8456BT 429-460 Blue Thunder	\$ 949
Show Polishing (most \$110)	



Manifold Components

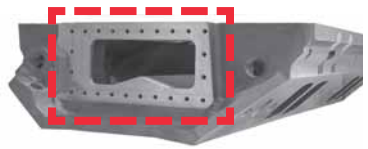

BDS-1401 Thermostat Housing Kit.....	\$ 49
B-7200 Swivel Thermostat Housing	\$ 29
BDS-1400-2 Billet Remote Housing	\$ 75
BDS-8366AK Large Backfire Valve Kit ..	\$ 49
B-5025.K Alum Blower Stud Kit 2.5"	\$ 35
B-5101 Machine for Burst Panel	\$175

Need Quality Gaskets? See Pages 17 & 42

Burst Panels

B-5100 Burst Panel, SFI Approved	\$ 25
B-5100-3 Burst Panel, <i>3 pack special!</i>	\$ 65
B-5102 2pc Alum Frame Kit w/ 24 bolts	\$ 65
B-5109 Burst Panel Alum Adapter	\$ 75
B-5110 Burst Panel Alum Adapter Weld-On	\$ 75



Panels are **SFI** Approved.
Very popular on Top Fuel
& Alcohol Engines.

Burst Panel Adapter

No welding or machining on older intakes.



PSI Blower Tandem Kit

2pc Alum Frame Kit. Has side brass fitting for quick check of inner panel. Also includes 24 Stainless-Steel bolts and 2 sfi burst panels.

B-5106 ... \$195



Blower Components

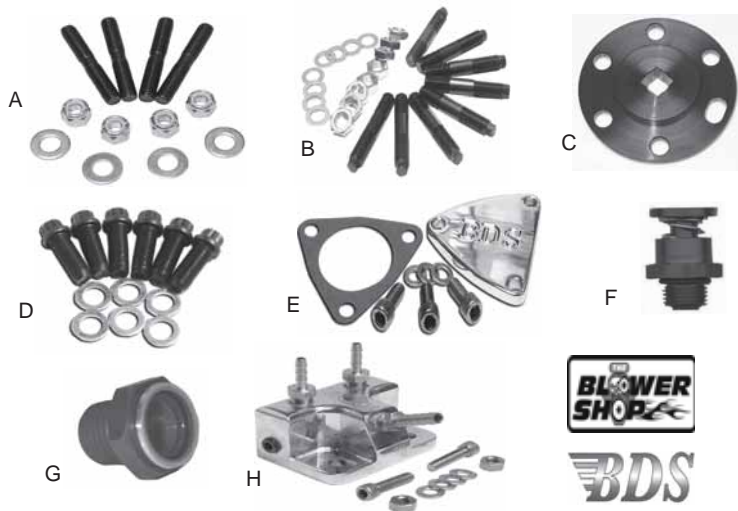

- A **B-5019** Injector Hat Stud Kit (4) \$ 11
- B **B-5025.K** Blower Stud Kit Alum 2.5" (8) \$ 35
Longer Blower Studs 3.00" & 3.50" (each) \$ 5
- C **B-5038** Alum Blower Turning Plate \$ 35
- D **F-375-13-100-6** 12pt Blower Pulley Bolts (6) \$ 12
- E **BDS-333K** Billet Tri-Plate Kit \$ 19
- F **B-5135** Pressure Relief Valve 1/8 Stainless Steel \$ 16
- F **B-5136** Pressure Relief Valve 7/16 Alum Black \$ 17
- G **B-5138** Oil Level Sight Gauge Lexan 1/4 NPT \$ 18
- G **BDS-556** Oil Level Sight Gauge Lexan 1/2-20 \$ 18
- H **BDS-1150** Trans Pressure Diversion Valve \$ 69

Street Snouts are Polished !

Blower Snouts

Drive Snouts are machined from billet aluminum. Has double ball bearings and HD oil seal. 48-Tooth spline shaft is made from heat-treated 4100 steel.



Shaft Size

Street 1.125
Race 1.250

Includes Grade 8 Bolts & Washers



- B-5300** Street Snout 3.90" \$ 298
- B-5310** Street Snout 5.75" \$ 338
- B-5302** Coupler for above \$ 86
- B-5340** Race Snout 3.90" \$ 289
- B-5342** Coupler for 3.90" \$ 74
- B-5350** Race Snout 5.25" \$ 299
- B-5352** Coupler for 5.25" \$ 79
- B-5360** Race Snout 6.00" \$ 339
- B-5362** Coupler for 6.00" \$ 84
- B-5370** Race Snout 7.00" \$ 359
- B-5372** Coupler for 7.00" \$ 89

Blower Front Covers



Complete Kit includes: Cover, Pressure Relief Valve, Sight Gauge, Gaskets, Bolts & Washers.

- BDS-671-1C** Cover Only -Satin \$ 115
- BDS-671-1CP** Cover Only -Polished \$ 139
- B-5220** Cover Only -BILLET ! \$ 189
- BDS-671-1CK** Cover Kit -Satin \$ 149
- BDS-671-1CKP** Cover Kit -Polished \$ 169

Specify: Half or Full Round

Bearing Plates and Covers are available in Polished or Satin Finish.

Works on most brands of blowers.

Blower Bearing Plates

Front Plates includes:

Heat-Treated dowels & Bearing Retainers (pr).

FRONT



Specify: All Square (Detroit style), Half Round or All Round

Rear Plates includes:

Heat-Treated dowels & Bearing Caps (pr).

Cast REAR Billet

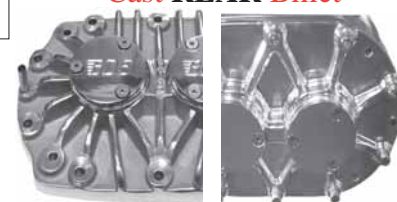

- BDS-671-2C** Front Plate *Satin* \$ 109
- BDS-671-2CP** Front Plate *Polished* \$ 119
- BDS-671-4** Rear Plate *Satin* \$ 129
- BDS-671-4P** Rear Plate -*Polished* \$ 154
- TBS-1100** Rear Plate Billet *Polished* \$ 179
- BDS-671-5** Rear Bearings Caps Pr. \$ 25
- BDS-671-22** Bearing Retainer Pr. \$ 29
- G-3320** Bearing/Seal Kit Street (4) \$ 89
- G-3322** Bearing/Seal Kit Comp (4) \$ 119

Bearings & Seals also Sold Separate

Belt Guards & Components

Bolts Right on! No Add't Hardware Required

Billet Aluminum
Stainless Steel Fasteners
Polished or Black Finish

Lengths available: **6, 7.5, 8.5, 10, 12"**

Roots & Screws

B-5006 Polished \$139
B-5006.B Black \$139

3-Hole SSI & PSI

B-5015 Polished \$159
B-5015.B Black \$159

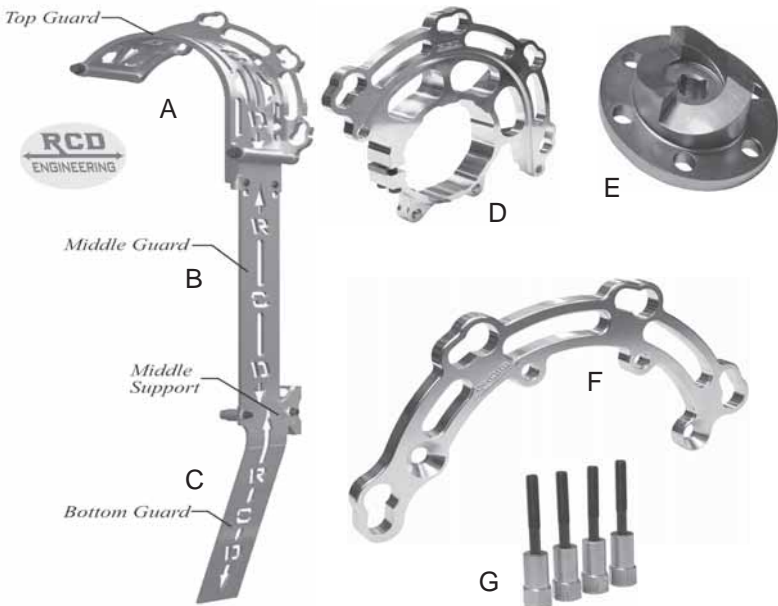

- RCD-103507-0010** Top Belt Guard, SSI 3-Hole **\$ 159**
- RCD-103507-0018** Top Belt Guard, Snout Mntd **\$ 165**
- RCD-157019-15** Snout Mounted Guard Clamp **\$ 139**
(Specify with or w/o Starter Bracket for Belt Guards)
- A. RCD-103507-0004** Top Belt Guard, Roots **\$ 159**
- B. RCD-103512-10** Middle Belt Guard **\$ 49**
- C. RCD-103522-0003** Lower Belt Guard **\$ 134**
- D. RCD-103507-51** Starter Face Plate & Clamp ... **\$ 253**
- E. B-5040** Steel 6 Hole Starter Dog **\$ 66**
- F. RCD-103507-03** Blower Starter Face Plate **\$ 68**
- G. Belt Guard Mounting Kit** For RCD Guards **\$ 59**

Mounting Kits Available from 1.75" - 3.00" standoffs

Blower Gaskets

These premium gaskets are race tested and proven in Top Fuel/ Alcohol & Blown Gas.
Re-usable!

Blower Base

G-2022 6.71 **\$ 9**
G-2022.3 3-Pack ... **\$ 24**
G-2028 8-10.71 ... **\$ 9**
G-2028.3 3-Pack **\$ 24**
G-2032 14.71 **\$ 12**
G-2032.3 3-Pack **\$ 32**



Blower Inlet

G-2012 Small w/o Screen **\$ 7**
G-2012.3 3-Pack Special **\$ 15**
G-2014 Small w/ Screen **\$ 9**
G-2014.3 3-Pack Special **\$ 22**
G-2016 Large w/o Screen **\$ 7**
G-2016.3 3-Pack Special **\$ 15**



Blower Front Cover \$5ea



G-2058 Blower Snout **\$3** **G-2059** w/ Bolts **\$5**

Bearings & Seals

Blower seals are heavy duty, double-lipped teflon and designed for extreme temperature and pressure. Bearings are long-lasting, premium quality.

Blower Bearings ea.

G-3312 Rear **\$ 14**
G-3314 Front **\$ 17**
Blower Seals ea.
G-3300 Std **\$ 8**
G-3302 O/S **\$ 8**
G-3304 Shaft Saver **\$ 5**
Bearing/Seal Kits (4)
G-3320 Street **\$ 89**
G-3322 Race **\$ 119**



Blower Snouts

G-2060 Seal 1.125 **\$ 8**
G-2062 Seal 1.250 **\$ 15**
G-2061 Bearing 1.125 **\$ 19**
G-2063 Bearing 1.250 **\$ 19**

BUNA O-Ring Material

G-3020 3/32 Manifolds,
G-3022 1/8 Heads, etc..
G-3024 3/16 **\$.95 ft**

Same Day Shipping!

800/576-7661

Chromoly Crank Hubs

Hubs are designed to replace your harmonic balancer. Machined from 4100 steel and broached for 2 keyways.



Internal Balance



External Balance



Hub with optional Degree Ring Installed



Internal Bearing Support
426 Hemi



354-417 Hemi



426 Hemi PSI Spline

Race Tested & Proven in Top Fuel and Alky!

12pt Blower Pulley Bolts

Aerospace Quality 3/8-24 x 1.00"
Includes Washers

F-375-13-100-6 .. \$11.95 (6 Pack)



Billet Crank Hub Degree Rings

Billet Aluminum
6.375 or 7" Diameter
1 Degree Increment

w/o Magnets

B-2032 6.375" \$ 69

B-2034 7.000" \$ 69

with Magnets

B-2033 6.375" \$119

B-2037 7.000" \$119

B-2038 7.000" Offset \$179



Standard



Offset

Dampner/ Crank Hub Installation Kit

Premium Quality
Remove & Install
Heavy Duty Case
T-1110 \$99



B-2040 SBC Int Bal 3/16-1/4 Keys	\$ 125
B-2042 SBC Ext Bal 3/16-1/4 Keys	\$ 199
B-2053 BBC Int Bal 3/16-1/4 Keys	\$ 125
B-2054 BBC Int Bal Dual 1/4 Keys	\$ 125
B-2055 BBC Ext Bal 3/16-1/4 Keys	\$ 229
B-2056 BBC Ext Bal Dual 1/4 Keys	\$ 229
B-2060 Hemi 426 PSI Spline	\$ 169
B-2064 Hemi 426 Dual 1/4 Keys	\$ 139
B-2066 Hemi 426 Internal Brng Sppt	\$ 269
RCD-202803-04 Hemi 354-417.....	\$ 184
BDS-139 Hemi 354-417 3/16-1/4 Keys	\$ 139
BDS-120C Ford 302-351W-351C	\$ 219
BDS-125 Ford 390-460	\$ 129

Crank Bolts 7/16 - 1/2 - 3/4"



From.. \$39

Chrome-Moly Steel
Black Oxide Finish
Gun Drilled
Heat-Treated

Chevy
Hemi
Ford

Front Bearing Supports



Chrome-moly crank hub
Billet aluminum plate & standoffs
Minimize crank flex & bearing damage



Bearing Supports

RCD-202200-0002 Bearing Support SBC	\$ 486
RCD-202400-0002 Bearing Support BBC	\$ 499
RCD-202600-0004 Bearing Support HEMI	\$ 692

Long Crank Hubs for Bearing Support

B-2046 Crank Hub SBC 3/16 & 1/4 Keyways	\$ 329
B-2057 Crank Hub BBC 3/16 & 1/4 Keyways	\$ 329
B-2058 Crank Hub BBC Dual 1/4 Keyways	\$ 329
RCD-202603-0020 Crank Hub HEMI	\$ 384
B-2066 Hemi Dual 1/4 Key (Rear Support)	\$ 269



Crank Triggers

The pick-ups use a 100% coverage foil shield, twisted pair cable for maximum noise rejection and covered with fire-sleeve. The coil is precision wound on a nylon bobbin for long life. Pickups employ a separate 16" ground wire for shielding and maximum radio frequency and electromagnetic noise rejection. This can be trimmed to fit and grounded to the chassis or motor. The highest quality gold plated terminals in the plug make sure that the connection stays corrosion free. These pickup sensors are a smooth 3/8" diameter and fit perfectly in most 3/8" size pickup holders.

This easy to use adapter allows you to adapt 3/4"-16 style pickup brackets to use the smooth 3/8" pickups (usually used with straight pickups).

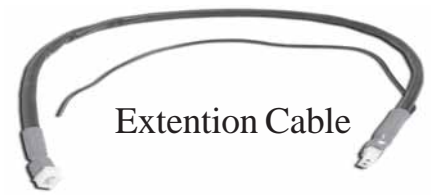
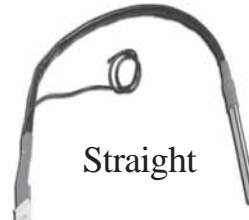

- I-3118 Pickup Straight 18" **\$ 119**
- I-3126 Pickup Straight 26" **\$ 119**
- I-3218 Pickup 90 Deg 18" **\$ 119**
- I-3226 Pickup 90 Deg 26" **\$ 119**

- I-3102 Extention Cable 24" **\$ 30**
- I-3103 Extention Cable 36" **\$ 30**

- I-3201 Pickup Adap 3/4-16 to 3/8 **\$ 39**

Trigger Brackets



Crank Trigger Brackets are machined from billet aluminum. Designed to mount to the right side (passenger) or left side (driver). Utilizes the Pickup Holders shown to the right.

- I-3310 SBC Right
- I-3312 SBC Left

\$69

- I-3314 BBC Right
- I-3316 BBC Left
- I-3318 Hemi Right
- I-3320 Hemi Left

\$79

Pickup Holders

Crank Trigger Pickup Holders are machined from billet aluminum and are designed to hold the 3/8 threaded or smooth pick-ups.



\$49

Slides into:
SBC, BBC, Hemi Trigger Brackets

- I-3303 3/8 Smooth
- I-3305 3/8 Threaded

Billet Pointers

Crank Trigger Pointer Assembly is machined from billet aluminum and is adjustable by 14°. Designed for a 7" degree ring and allows precise reading of the engine timing. NHRA Legal. Fits HEMIs including TFX, BAE, etc..

Hemi 7"



\$ 35

RCD-202000-0010

ADJUSTABLE



\$59

- B-2020 SB Chevy
- B-2022 BB Chevy

Works with 6 3/8 or 7in degree ring.

Pointer Assembly is machined from billet aluminum and is adjustable. Will work on 6 3/8 or 7in degree ring. Allows for precise reading of engine timing. Includes mounting hardware. One of the nicest pointers on the market. *Chevy only.*

Need some **FREE** Tuning Advice?

Call upon the Good Vibrations team. They have won an unprecedented 5 CIFCA Championships. And they are eager to share their knowledge and experience with you.

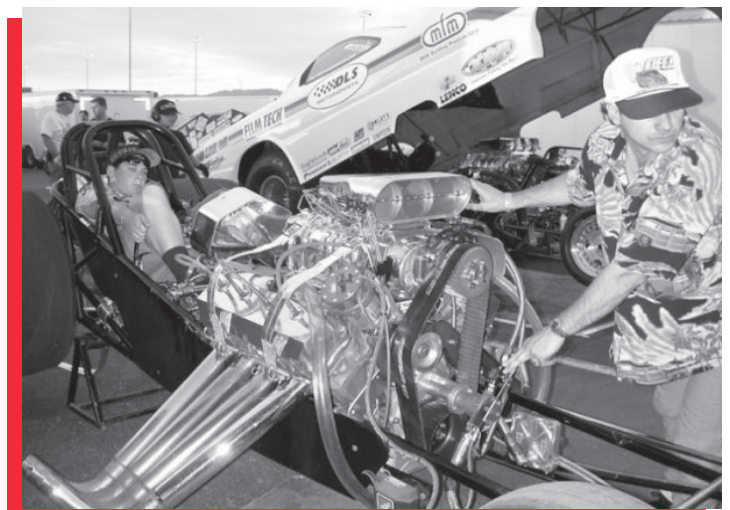

Our Ultimate Goal is Your Success.



Billet Idler Pulleys and Brackets

Machined from Billet 6061-T6 and Show Polished



Billet Idler Pulley

Idler Pulleys are machined from 6061-T6 aluminum. Feature an offset double ball bearing. Crowned center helps keep blower belt centered.

3.25 or 4.5in Diameter.

Includes: Idler Pulley, Alum Standoff and Washer.



B-6092 2" wide x 3.25" **\$ 139**

B-6095 3" wide x 3.25" **\$ 139**

B-6096 3" wide x 4.50" **\$ 159**

B-6090 Steel T-Nut **\$ 25**



Aluminum Idler Pulley Spacers

Spacer Widths .400 to 1.400 **From \$10**



Blower Mounted

Billet L-Shape bracket mounts directly to the front of most roots blowers.

Kit Includes: Bracket, T-Nut, Bolts and Alum Standoffs.

B-6000 Bracket Only **\$ 67**

B-6001 Standard Kit **\$ 145**

B-6002 Long Kit **\$ 149**

Long Kits include .700 spacer & longer bolt.



Swing Arm

Billet Swing Arm Bracket clamps to snouts (with 3.38" OD). Allows one to adjust the idler pulley For and Aft.

B-6007 Billet Arm **\$ 139**

Idler Bolt 5/8-11 x 4" **\$ 5**

Engine Mounted Kits

Includes: Polished Alum Bracket, Water Standoffs (Drilled & Tapped AN8), Mounting Spacers & Bolts, Idler Bolt & Chromoly T-Nut.



B-6041 SB Chevy Kit **\$ 199**
B-6051 BB Chevy Kit

Engine Mounted Brackets



SBC



BBC



392 Hemi



426 Hemi

B-6040 SB Chevy **\$ 109**

B-6050 BB Chevy **\$ 109**

B-6060 426 Hemi **\$ 165**

156206-09 392 Hemi **\$ 159**

Mounts to Engine Block. 3/4" Aluminum Prevents Warpage.

Outboard Support HEMI Kit

Includes: Alum Bracket, Outboard Support, 3.10" Idler Pulley, Bolt, T-Nut and Hardware. Fits BAE, KB, TFX.

Mount for Dunn Offset Mag Drive



B-6065 Hemi Kit **\$449**

B-6067 Magneto Mount **\$ 98**

HEMI Outboard Support Bracket Angled w/ T-Nut & Mounting Hardware.

BAE, KB, TFX.

No idler pulley or outboard support



B-6062 Hemi **\$214**



Dual Carb Scoops



\$249

Fits Blowers & Most Tunnel Rams

Scoops are replicas of the famous Bugcatcher Injector. Designed to fit single or dual carbs. Highly polished with anodized butterflies.

Complete with Mounting Hardware and Filters!

ACC-2522 .. Smooth ACC-2520 .. Ribbed

Dual Carbs:
7.75 - 9.25 c-c

Hilborn-Style

Hilborn-style scoops are designed for single or dual carbs on Tunnel Rams & Blowers.

Polished aluminum with finned or smooth top.

Includes: Adjustable mounting hardware, front screen & filter(s).



- ACC-2527 Single Carb \$ 129
- ACC-2525 Dual Carb \$ 149
- ACC-2523 Shotgun-Style .. \$ 249

Carb Adapter Plate

Carb Plate Includes: Billet Plate, Screen Gasket, Carb Base Gaskets, Cadum Plated Bolts & Washers.



Dual four barrel carb adapter plate for a 6.71 or 8.71 blower. Accepts two **Standard** Holley carbs sidesaddle or Carter carbs inline on an 8-5/8" center to center. Holley carbs without secondary metering plates may be run inline.

B-9050 Dual Standard \$ 139

Dual Holley **Dominator** carb plate. Accepts two Holley Dominator carbs mounted sidesaddle at 8-3/4" center to center. **B-9053 Dom \$ 139**

Single four barrel carb adapter plate for 6.71 or 8.71 blower. Accepts **Standard** Holley and Carter four barrel carbs.

BDS-14B6-2 Single Carb \$ 129

SS Carb Plumbing



3/8" seamless **polished Stainless Steel** tubing with anodized fittings (or SS) for two double pump carbs mounted sidesaddle. Includes carb fuel inlet to AN6 fittings and provides a AN6 Tee fuel connection per carb to supply fuel to both carb bowls.

- | | |
|------------------------|------------------------|
| 4150 Dual Lines | 4500 Dual Lines |
| B-9201 Blue \$149 | B-9207 Blue \$149 |
| B-9202 Black \$149 | B-9208 Black \$149 |
| B-9200 SS \$209 | B-9206 SS \$209 |

- | | |
|--------------------|--------------------|
| 4150 Bridal | 4500 Bridal |
| B-9221 Blue \$49 | B-9227 Blue \$49 |
| B-9222 Black \$49 | B-9228 Black \$49 |
| B-9220 SS \$55 | B-9226 SS \$55 |

Works on blowers and tunnel ram systems.

Blower Only Carb Scoops



Polished aluminum **Dual Carb** scoop for **Standard** four-barrel style carbs **mounted inline** or **side-saddle** on 8 5/8" centers. (Won't fit most Tunnel Rams)

- BDS-9000 Dual Carb Blower Scoop \$ 229**
- BDS-9000C Above w/ Filters \$ 299**



Polished **Dual Carb** scoop for **Dominator** style carbs mounted **side-saddle** on 8.75" centers.

- BDS-9000D-2 Dual Dom Scoop \$ 389**
- BDS-9000DC-2 Above w/ Filters..... \$ 519**



K&N Air Filter Element, Polished Stainless-Steel Top, Stud & Nut.
BDS-9100K STD Holley \$39 BDS-9100KD Dominator \$79



Heavy-Duty Vinyl Scoop Covers embroidered with BDS logo.
Colors: Black, Blue, Purple, Red, Yellow & Pink.
BDS-9001 Vinyl Cover \$25 BDS-9000D1 Dom Cover \$29



Same Day Shipping!

800/576-7661



Blower Starter

Lightweight & Removable
36-48-60 Volts



Simply the Best !



- RCD-100500-0011 Blower Starter **\$1839**
- RCD-100500-0020 Crank Mount Starter **\$1839**
- RCD-102505-0065 Battery Cables 15ft **\$ 129**
- RCD-102505-0005 200 Amp HD Relay **\$ 251**
- B-5045 Anti-Tipover Foot Alum **\$ 45**
- MMC-7043K82 Q.D. Battery End **\$ 19**
- RCD-101518-06 Starter Brush. Original **\$ 6**
- RCD-101520-17 Starter Brush. New style **\$ 8**

Designed for High Comp and Supercharged Engines

4.40 to 1 Gear Reduction
534 ft./lbs. Torque!
Lightweight (8.8lbs)
Compact and Adjustable
Heat Resistant Solenoid

Guaranteed with a Warranty !

US Patented

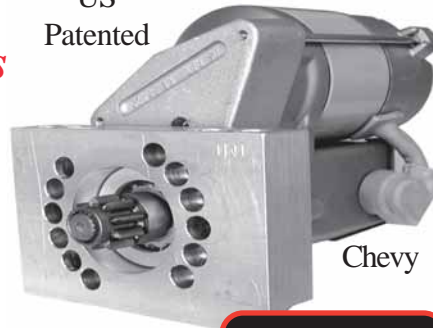

- 1.3hp **\$179**
- 1.9hp **\$219**
- 2.0kw **\$249**

- IMI-102 Chevy 1.3hp **\$ 179**
- IMI-102N Chevy 1.9hp **\$ 219**
- IMI-902 Chevy 2.0kw **\$ 249**
- IMI-935 Chevy 2.0kw Offset **\$ 259**
- IMI-108 Pont/Olds 1.3hp **\$ 179**
- IMI-108N Pont/Olds 1.9hp **\$ 219**
- IMI-141R KB Olds 1.4kw **\$ 229**
- IMI-106 Ford 1.3hp Auto **\$ 179**
- IMI-107 Ford 1.3hp Manual **\$ 179**
- IMI-906 Ford 2.0kw Auto **\$ 259**
- IMI-109 Mopar 1.3hp **\$ 179**
- IMI-101 VW-Porsche 1.3hp **\$ 179**
- IMI-101N VW-Prsche 1.9hp **\$ 219**

**Chevy
Pontiac
Olds
Ford
Marine
Mopar
VW
Porsche
Harley**



VW
Porsche

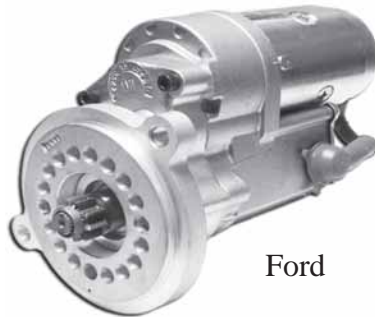

Ford



Customer's Ride

Top Fuel
Champion

Scott Whipple - Norco, California



12
Gallon

FC/Altered Fuel Cell

Specially designed with one AN12 pickup (optional AN16). Has one AN6 on top for venting. Multiple fuel injection lines can be easily installed near the top of this cell.

JAZ-290-112-01 **\$ 169**

Fabricated Valve Covers

Valve covers are fabricated from 6061 alum and welded with billet rails. Designed for the racers who demand a higher quality valve cover with extra room for valve train.



- ACC-2324 SB Chevy \$ 139
- ACC-2334 BB Chevy \$ 179
- ACC-2364 SB Ford \$ 149
- ACC-2344 BB Mopar 440 \$ 179
- ACC-2356 426 Hemi \$ 395

426 Hemi

ACC-2350



Show Polished Aluminum.
Use Stock Tubes.
Original Design.
Machined for Breathers.



Aluminum Valve Covers



Show Polished !



- * Tall for Clearance
- * Quality Casting
- * Recessed & Baffled
- * Hole for Breather

- ACC-2320 SB Chevy 283-350 \$ 79
- ACC-2330 BB Chevy 396-502 \$109
- ACC-2360 289-351W 5.0L Ford \$ 85
- ACC-2300 Wing Nut 1/4 -20 x 4in \$ 3

Dress Up Kits

Consist of chrome steel valve covers (baffled), breather cap and rubber grommets. Several kits contain chrome timing chain cover, dipstick with tube, wing nuts and timing tab.

- ACC-2420 SBC Kit - Short \$ 44.95
- ACC-2422 SBC Kit - Tall \$ 44.95
- ACC-2460 Ford 289-351W \$ 49.95
- ACC-2430 BBC Kit - Short \$ 54.95
- ACC-2432 BBC Kit - Tall \$ 54.95
- ACC-2440 SB Mopar Kit \$ 49.95
- ACC-2438 Pontiac Kit 331-455 \$ 49.95



Valve Cover Gaskets

Black rubber with solid steel core.



- G-2320 SBC \$ 12.95
- G-2325 BBC \$ 14.95
- G-2330 SBF \$ 12.95
- G-2335 351C \$ 14.95
- G-2340 428 \$ 14.95
- G-2345 BBF \$ 14.95
- G-2305 Mopar \$ 14.95
- G-2355 Olds \$ 14.95
- G-2350 Pont \$ 14.95

More Quality Gaskets?
See Page 42

Sealed Battery Box

Fits Standard Group 24 battery.
NHRA & IHRA Approved.
Measures 10.5 x 13 x 9.5" tall
Completely sealed lid.
Vent tube to carry battery gases
outside of vehicle.
Rotational molded plastic case is
resistant to battery acid.



JAZ-700-500-01

\$ 77



Mounting brackets and all hardware included!

Stainless Steel Battery Mount



Lightweight
Polished SS

**NHRA &
IHRA
Legal**

*Mounting
Hardware
Included*

- ACC-3100 Universal Mount **\$ 29**
- ACC-3103 Optima Yellow Top **\$ 88**
- ACC-3104 Optima Blue Top **\$ 99**
- ACC-3105 Optima Red Top **\$ 99**

Torque-Totes



Torque-Totes are designed to house an 8 to 11" torque converter in a dry and clean environment. Torque-Totes can also be used as shipping containers.

JAZ-700-100-07

\$ 52

Krank Kase

Prevents journal damage.
Great for transporting/storing
those expensive crankshafts.
Strong enough for shipping.



JAZ-700-300-07 SBC
JAZ-700-301-11 BBC

\$ 67

Roll Bar Padding



SFI 45.1

\$22.95

Black Red Blue

Rollbar padding is made of high-density foam. Fits 1-1/2" to 1-3/4" diameter tubing. 3/4" thickness. **3 ft length**

Also Available for Helmet Bars (1 - 1.25")



Foam Padding
3' Length

\$7.95

Black, Silver, Red, Orange, Yellow, Blue



Head Kase

JAZ storage cases are designed to house a complete cylinder head with studs and springs in a clean and safe environment. Great for shipping.

JAZ-700-200-07 SBC .. \$ 74.95ea

JAZ-700-201-11 BBC .. \$ 81.95ea



Third Member Storage Case



Keeps third member free of dirt. Fits all Ford 9" and are stackable. Built-in handles makes for easy handling. Great for shipping and storage.

JAZ-700-009-01 Horizontal ... \$ 51.95

JAZ-700-010-01 Vertical \$ 54.95



Breather Tanks

This remote 1qt breather/ oil separator easily mounts to a rollbar or firewall. Comes standard with molded-in inserts and a swivel petcock for easy draining.

- JAZ-605-025 AN6 **\$ 45.95**
- JAZ-605-825 AN8 **\$ 47.95**
- JAZ-605-125 AN10 **\$ 52.95**
- JAZ-605-225 AN12 **\$ 61.95**
- JAZ-605-000 Blank **\$ 34.95**



Mini Breathers

\$ 62

Jr Dragsters, Go Carts & small CID Engines

Similar to above breathers but is 1 pint and has two 3/8 or 1/4 hose barbs.

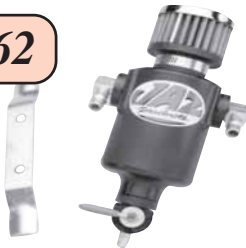

JAZ-605-375



Radiator Overflow Catch-Cans

One-piece molded construction with unique swivel elbow input. Lever handle petcock for easy draining. Meets NHRA requirements for 1qt. capacity. Easy mounting with molded-in threaded inserts.

JAZ-600-025

\$ 21

Colors: Black, Red, Blue, Purple, Orange, Clear



Stainless Steel Overflow

New !

High Luster SS
2pt Capacity

w/ Mounting Bracket

ACC-3120 2 x 19"

ACC-3122 3 x 10"

\$ 45

Fuel Cell Tip Over Valve

\$22

Fuel cell vent prevent fuel spill if tipped upside-down

JAZ-834-006 AN6

JAZ-834-008 AN8



Small Fuel Cells



Cells are designed for applications utilizing gas & alcohol fuel. The 1 gallon features an aircraft style cap, 1/4" petcock fitting for fuel pickup and vent.



JAZ-230-025-01 1 Quart **\$ 46.97**

JAZ-230-051-01 2 Quart **\$ 59.97**

JAZ-230-001-01 1 Gallon **\$ 120.97**

Funnels & Filters

JAZ funnels feature anti-splash lips. Can be cut to desired length & flow rate. 11 & 14" accepts 60 micron Stainless Steel filter.



JAZ-555-008-06 8" Round **\$ 15.95**

JAZ-555-011-06 11" Round **\$ 23.95**

JAZ-550-014-06 14" Triangular **\$ 15.95**

JAZ-500-000-01 Filter 60 micron **\$ 21.95**

Testimonial

On my recent purchase at first I was apprehensive as I have had a lot of dealings with US companies. I have found them to be after the quick buck charging large freight prices and jacking up prices. Seems strange because if they had of looked after us we would spend more money with them! Your Staff And Company is very easy to deal with and we the Customer was always informed on progress and shipping. Thanks Very Much and we will buy from you again.

Regards,
Andrew Hurst--Hurstune Automotive
Smeaton Grange Australia



Same Day Shipping!

800/576-7661

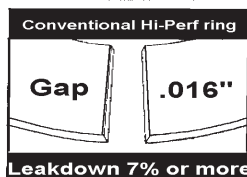

Leakdown 7% or more

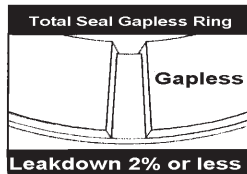

Leakdown 2% or less

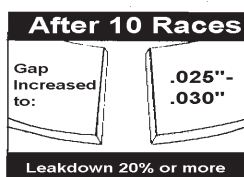

Leakdown 20% or more

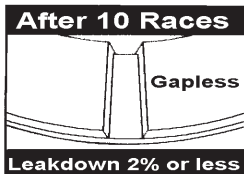

Leakdown 2% or less

Gapless Piston Rings

As a normal ring wears, the gap opens up allowing more combustion gasses to escape. The Total Seal Gapless ring has no gap. Instead, its patented design incorporates a 2-part interlocking ring to close the gap and provide a more perfect seal between the piston and cylinder.



Keeps Leakdown to 2% or Less!

Leakdown Tester



Dual Gauge
w/ 14mm Hose
Professional Grade
T-2002

Ring Compressor



Heat Treated
Anodized Alum
\$ 39

Ring Filer

Files piston rings simply and accurately.

Bench mounted



Gapless 2nd RACE Sets (1/16 1/16 3/16)

4.035 TS-T3690.35	\$ 228	4.355 TS-T6490.35	\$ 232
4.065 TS-T3690.65	\$ 228	4.385 TS-T6490.65	\$ 232
4.155 TS-T0690.30	\$ 228	4.445 TS-T9190.195	\$ 232
4.255 TS-T9190.05	\$ 232	4.505 TS-T9190.255	\$ 232
4.285 TS-T9190.35	\$ 232	4.567 TS-T9130.5	\$ 256
4.315 TS-T9190.65	\$ 232	4.605 TS-T9150.5	\$ 256

Most Popular Sizes Including *Dykes* are in Stock

KING Premium Engine Bearings



Proven effective on circle track engines running at 8000rpm, on Top Fuel Blown Engines producing 5500HP as well as on high performance street vehicles. Alecular material offers an extremely high temperature threshold and high load capacity.

R O D

X-CR-848HPSTD	SBC w/o Dowel	62.99
X-CR-848HPSTD-X	SBC .001 Oversize w/o Dowel	62.99
X-CR-850HP010	305 SBC .010 w/ Dowel	65.99
X-CR-850HPSTD	305 SBC STD w/ Dowel	65.99
X-CR-850HPSTD-X	305 SBC .001 Oversize w/ Dowel	65.99
X-CR-850HP020	305 SBC .020 w/ Dowel	65.99
X-CR-851HP020	327 SBC .020 w/o Dowel	60.99
X-CR-853HP001	BBC .001 w/ Dowel	84.99
X-CR-853HP010	BBC .010 w/ Dowel	84.99
X-CR-853HP020	BBC .020 w/ Dowel	84.99
X-CR-853HPSTD	BBC STD w/ Dowel	84.99
X-CR-853HPSTD-X	BBC .001 Oversize w/ Dowel	84.99
X-CR-849HP010	BBC .010 w/o Dowel	79.99
X-CR-849HPSTD	BBC STD w/o Dowel	80.99
X-CR-840HP	426 HEMI w/ Dowel	95.99
X-CR-840HP001	426 HEMI .001 w/ Dowel	95.99
X-CR-840HP010	426 HEMI .010 w/ Dowel	95.99
X-CR-863HP	426 HEMI Upper Only	95.99

M

X-MB-5142HPSTD	SBC	73.99
X-MB-5142HPSTD-X	SBC .001 Oversize	73.99
X-MB-5142HP020	SBC .020	73.99
X-MB-5147HPSTD	BBC STD 3/4 Groove	91.99
X-MB-5147HPSTD-X	BBC .001 Oversize 3/4 Groove	91.99
X-MB-5147HP001	BBC .001 3/4 Groove	91.99
X-MB-5147HP010	BBC .010 3/4 Groove	91.99
X-MB-5147HP020	BBC .020 3/4 Groove	91.99
X-MB-5164HPSTD	BBC STD Full Groove	91.99
X-MB-5164HP010	BBC .010 Full Groove	91.99
X-MB-5116HP	426 HEMI	79.99
X-MB-5116HP010	426 HEMI .010	79.99

A

I

N

Blower Restraints



Billet 7075-T6 Aluminum
Silver Aluminized Straps
Quick Disconnect Pins

Re-certifiable

- DJ-141000 Restraint w/ Hardware SFI 14.1 **\$ 319**
- Restraint Only, No Hardware SFI 14.1 **\$ 249**
- DJ-141999 Re-Certification SFI 14.1 **\$ 79**
- DJ-141002 Adjustable Silver Straps (4ea) .. **\$ 119**
- DJ-141900 Mounting Hardware w/ pins **\$ 125**
- DJ-142007 Top Alcohol Restraint with Kevlar Ballistic Bag and Steel Hardware. SFI 14.2 **\$1049**
- DJ-143103 Top Fuel Restraint with Kevlar Ballistic Bag and Steel Hardware SFI 14.3 **\$1598**

Need Premium Gaskets? See Page 17

Window & Wheelie Bar Nets

- DJ-221721 Angular 17x21 **\$ 44**
- DJ-221824 Square 18x24 **\$ 33**
- JAZ-906-03 Installation kit **\$ 57**
- DJ-220001 Wheelie Bar **\$ 59**



SFI 27.1

Trans Blankets



Multiple layers of Ballistic material to capture exploding shrapnel.

*Perfect Fit
Water - Oil Resistant
Dozens in Stock
Custom Available
Re-certifiable !*

Sportsman Engine Diapers

SFI 7.2

Snap-in Absorbant Pads.
Q.D. Adjustable Straps.
Tailored Fit. Ballistic Nylon.

- DJ-730281 **SB Ford**
- DJ-730350 **SB Chevy**
- DJ-730454 **BB Chevy**
- DJ-730426 **426 Hemi**



\$195

Most Other Makes in Stock!

Pro Engine Diapers

SFI 7.1

Adjustable quick-release buckles attaches to the header flanges.
Reusable Snap-in Absorbant Pads.
Can be recertified.



**TF/TA
Legal**

- DJ-711001.bal Soft Ballistic Nylon **\$ 548**
- DJ-711002 Soft Kevlar (shown) ... **\$ 779**
- DJ-710002 Carbon Fiber Bucket ... **\$ 949**
- DJ-710401 Replacement Pads (pr) **\$ 59**

Plug Wire Shield

Protect spark plug wires in the event of a burst panel or blower back-fire.



DJ-070200 ... \$ 19.99

Heavy-Duty Race Car Tiedowns

Webbing is 1.75" wide. Burst Strength: 5,000lbs
Snap-in J-Hooks Ends. American Made!

- A. DJ-236201.12 Inline Ratchet Tiedown .. **\$ 27.95**
- B. DJ-236205.8 w/ Sewn-In Axle Loop **\$ 29.95**
- C. DJ-238044 Flush Mounted D-Ring **\$ 9.99**
- D. DJ-237224 Heavy-Duty Axle Strap 24" **\$ 10.95**
- E. D-36605 Cycle Tiedown w/ S-Hook **\$ 8.50**
- DJ-241202 Heavy Duty Tow Strap 14' **\$ 26.99**

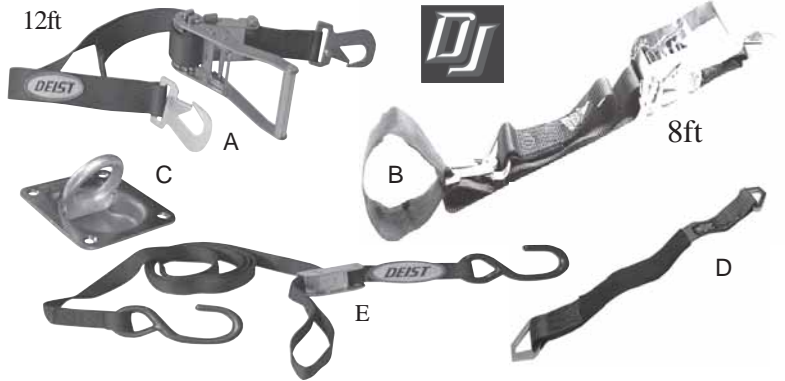

Don't trust your race car to inferior brands !

Seat Belts and Harnesses

DJ Safety offers over 100 combinations of 5pt Seat Harnesses.
Options include: Latch/Link design or Quick-Release (CamLock)
 2" or 3" wide. **3 Styles of Attachment:** Wrap-around, Bolt-in or Snap-in.



Cam
\$159

SFI 16.1

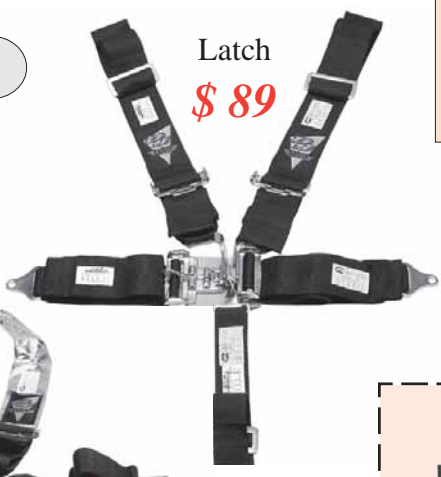

Latch
\$ 89



Also Available
in 6 & 7pt.

Colors:
Black, Red & Blue
Fresh Dates!

Seat Belts Out-of-Date?

5pt Latch/Link style ... <i>most</i>	\$ 89
w/ Fire Protective Covering	\$ 149
5pt Cam Lock style	\$ 159
w/ Fire Protective Covering	\$ 198
Rewebb & Recert <i>most</i>	\$ 69
w/ Fire Protective Covering	\$ 109



Cam Lock



Latch/Link

Buckle Styles

Belt Mounting Options

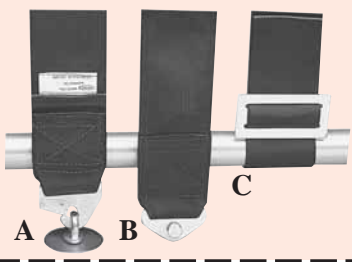

A

B

C

- A. Snap-In
- B. Bolt-In
- C. Wrap Around

Premium Mechanix Gloves

Designed to help the professional mechanic with increased grip. Protects from heat & cold. Features CLARINO palm, 3-ply mesh top and elastic Velcro wrist.

Sizes: XS-XL



\$19



Heat Sleeves

Features 100% heat-resistant woven Kevlar fabric, extra long sleeve protects arm above the elbow, oil and fuel resistant, snug fit allows comfortable fit.

MG-05-902

\$25



Premium Seatbelt Hardware

Hardware is made of high quality steel for that measure of safety you are looking for and deserve.



- A. DJ-600105 Snap-In Kit w/ Hardware **\$ 6.95**
- B. DJ-600305 Floor Mount Kit w/Hrdwr (pr) **\$ 6.95**
- C. DJ-600402 3-Bar Adjuster 2" (pr) **\$ 3.95**
- C. DJ-600403 3-Bar Adjuster 3" (pr) **\$ 5.95**

Shoulder Pads

- D-70200 2" Slip-On Pads **\$ 19**
- DJ-603050 3" Fire Retardant Pads **\$ 36**

Sold in Pairs



Shoulder pads are available as Slip-Ons or Sewn-In.
Great Driver Comfort.

Arm Restraints

Arm Restraints have velcro closure and are adjustable in length.



SFI 3.3

DJ-605000 Arm Restraints **\$ 29/pr**



Open 24/7 at:
GoodVibrationsRacing.com

800/576-7661

Too Fast? We Can Stop You!

Drag Chutes



Over a Dozen styles
to choose from !!

Black * Red * Blue

- DJ-851252 Super Quad (s/g, s/c) \$ 219
- DJ-851424 Blown Gas or Alcohol Boat \$ 439
- DJ-851070 Pro Mod & Top Alcohol \$ 399
- DJ-851079 Top Fuel Dragster/ FC \$ 425
- D-30470 Nylon Pack 7x7 \$ 79
- DJ-852999 Nylon Pack 9x9 \$ 69
- DJ-852996 Silver Pack 9x9 \$ 98
- DJ-852809 Pilot Chute Heavy Duty \$ 69
- DJ-852200 Release Cable with Lever \$ 39
- DJ-911341 "Remove Before Run" Flag \$ 5



Video: *How to Pack Your Chute*

Chutes Include: Quad Cross-Form Canopy, Pack, Pilot and Bridle Line.

Coldfire 302 Fire Systems

Coldfire302 is a harmless plant & water based fire suppressing agent. Is especially effective in Class B fires (Oil/fuel). Also suitable for wood & paper fires. Suppresses quickly, prevents reflash, safe to store and leaves virtually no residue. Biodegradable and environmentally safe.



Systems for Most Applications

Systems		
DJ-911050	5lb	\$ 369
DJ-911100	10lb	\$ 399
DJ-911100.FC	20lb	\$ 899

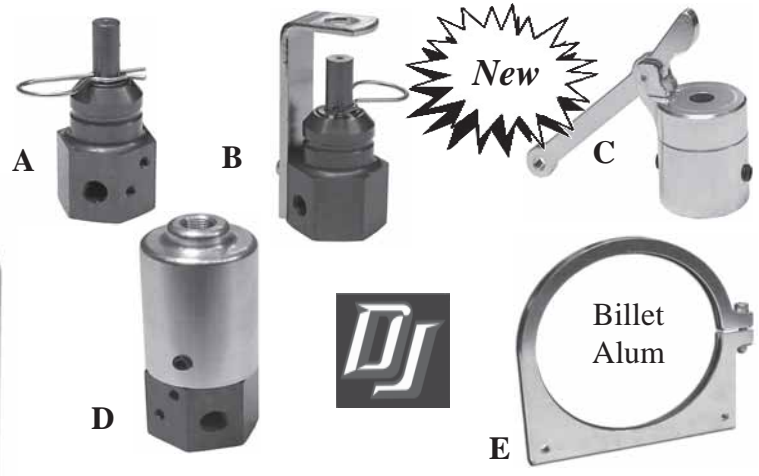

- DJ-911101 10lb Bottle Only \$ 299
- A. DJ-911327 Manual Injector \$ 79
- B. DJ-911328 Mnl Injector & Bracket \$ 85
- C. DJ-911329-2 Pull-Style Adapter \$ 59
- D. DJ-911329 Pneumatic Injector \$ 149
- E. C-8420 Mounting Bracket 5.25 \$ 33
- D-89260.438 Mounting Bracket 4.38 \$ 29
- DJ-911311 Nozzle & Fitting Kit 3pc \$ 79
- Alum Tubing 1/4" (10ft Coil) \$ 14
- CC-86U04 Remote Cable *From* 3ft \$ 49

Accepted by Most Sanctioning Bodies

Fire System is DOT & SFI Approved.
Bottles can also be Refilled.

Nomex Driving Suits

Driving Suits are manufactured to meet one of the following specs:
SFI 3.2A/1, 5 or 20.
 Standard Suits are one solid color with contrasting trim.

Sizes: S-XXL
Colors: Black Red Blue

DJ Safety sfi /20 suits can be recertified every 5 years!

Options:
 Arm Restraints
 Kool Pad Pockets
 Embroidery



SFI 1 Suits (1 Layer)	
DJ-011200 Jacket ..	\$ 79
DJ-011300 Pants	\$ 69
DJ-011100 1pc Suit .	\$ 129
SFI 5 Suits (2 Layer)	
DJ-012200 Jacket ...	\$ 169
DJ-012300 Pants	\$ 169
DJ-012100 1pc Suit	\$ 299
SFI 20 Suits (4 Layer)	
DJ-014200 Jacket ...	\$ 699
DJ-014300 Pants	\$ 549
Sewn-in Restraints	\$ 59

Choose from 1pc or Separate Jacket and Pants

Driving Boots



DJ styling Driving Shoes feature padded Kevlar lining and velcro closure.



Sizes: 6-13 in Full Sizes
Colors: Black Red Blue Gray

- DJ-050000 sfi 3.3/5 Shoes \$ 79
- DJ-051000 Alky/TF sfi 3.3/20 Boots \$ 229

Kool Vest

Keeps driver or crew member comfortable for upwards of an hour. Thin vest easily fits under driver's suit. Has one pad on upper back and one on each kidney.



Sizes: S-XXL

- D-03520 ... \$ 79
- D-03520-3 Extra/Replacement Kool Pads \$8.99ea

Driving Gloves

Leather Palm Gloves offer excellent protection while maintaining a high level of comfort.

- D-04100.331 Nomex sfi 3.3/1 \$ 77
- DJ-022000 Nomex sfi 3.3/5 \$ 59
- DJ-024000 Nomex sfi 3.3/15 \$ 129
- D-84600 Nomex sfi 3.3/20 \$ 139



Colors: Black Red Blue

How to Measure Glove Size:

Lay hand flat with fingers and thumb together. Measure circumference at widest point.

9" = Sml
 10" = Med
 11" = Lrg
 12" = XL

Video 



Race Helmets



Helmets are built to meet and exceed Snell 2010. The "SA" rating has a fire-resistant liner.

Full Face

Sizes: XS-XXL

SA2010 \$ 299

M2010 \$ 279



Open Face

Sizes: XS-XXL

SA2010 \$ 279



Note: Blown Alcohol & Nitro applications usually requires a Snell "SA" rating

How to Measure Helmet Size

Video



Hat Size Circumference

XS 6 1/2".... 21 5/8"

S 7"..... 22"

S 7 1/8".... 22 3/8"

M 7 1/4" 22 3/4"

M 7 3/8" 23 1/8"

L 7 1/2" 23 1/2"

XL 7 5/8" ... 24"

XXL 8" 25"

To properly determine head circumference, run a soft tape measure around your head (approximately one inch above your eyebrows and just over the ears).

Testimonial

I just wanted to thank you for your excellent service. Parts must of been dispatched within minutes of me ordering & arrived safe & sound today. Total time from ordering to delivery was just 3 days, excellent service considering I live in England. Once again, thanks & I look forward to the next time we do business.

Cheers,
Mark Sheridan, Middlesex, England



Equipment Bags



Made from a high quality rip-stop nylon. Internal padding. 3 pockets.

Helmet Bag

DJ-036010 \$29.95

Gear Bag

DJ-070410 \$49.95



Helmet Supports

Velcro Closure

SFI Approved

DJ-040009 \$ 29



Tapered For Comfortable Fit

Head Socks/ Underwear

Head Socks are designed to be worn under the helmet. These soft nomex knit hoods provide an extra measure of protection. Nomex underwear are also soft and gives a driver a few extra critical seconds of time.

D-03211 1 Layer Sock ... \$ 31

DJ-062002 2 Layer, *sfi 3.3* \$ 45

DJ-060000 Top S-XL \$ 69

DJ-061000 Pants S-XL \$ 69

DJ-063040 Socks \$ 22



Nostalgia Mask

Made of aluminized silver.

Includes breathers.

D-83110-SIL Mask non-SFI \$ 349



We stock jr Dragster Safety Equipment !!



You just found those Hard-To-Find Tools !!



Cam Degree Installation

Makes degreing a cam a lot quicker and easier. This fixture attached to the block over cylinder #1 using two of the block studs (or bolts). An adjustable stop is included for helping determining top-dead center. Simply install a dial indicator into either the intake or exhaust hole of the fixture.

- T-1115 SBC
- T-1116 BBC
- T-1117 HEMI

\$159

Valve Lash Adjuster

Quickly and accurately adjust your valves with this custom tool. Machined from stainless steel for durability with choice of 7/16, 1/2 or 9/16 hex. Fits SBC, BB, Mopar & most Fords. *3/16 hardended Tip.*



\$59

Stainless Steel

- T-1125 7/16 Hex.
- T-1126 1/2 Hex.
- T-1127 9/16 Hex.

Main Cap Puller

The bottom-end guy sure appreciates this main cap slide puller. The 5/16 heat-treated threads are easily threaded into the main cap using the slip-proof knurled knob. A simple tug of the tool allows the cap & lower bearing to drop safely into your hand. A great asset for between round thrashes. Also great to have one at the shop.



T-1103 2.5 Lbs **\$59**

T-1100 4.5 lbs **\$89**

Adjustable AN Wrench T-1152 \$49

Protect the anodize on your AN Hose Ends. Knurl Thumbscrew. Minimizes chance of over-tightening.



Fits AN3-20

Hemi Top Dead Center Checker

Wanna' check your top dead center like a pro? Then grab one of these. Simply thread the checker into Cylinder #1 of your Hemi and rotate the crank until the dial indicator maxes out. A real time saver when trying to dial in a magneto or camshaft at the track.



T-1134

\$149



Push Rod Straightness Checker

\$139

Valve train failure is normally catastrophic and a bent push rod can be attributed as a culprit in many instances. A pushrod out-of-round as little as .010 will begin to flex. I'm sure you have seen the wear marks on the sides of your pushrods and wonders how they got there. With the Pushrod Checker, simply insert the pushrod into the spring loaded end, rotate 360 degrees and quickly check the roundness of a pushrod to less than .001.

- T-1120 BBC
- T-1121 FATHEAD
- T-1122 HEMI FUEL

Rod Bolt Stretch Checker

One simply inserts the rod bolt into the Bolt Stretch Checker and records the reading on the gauge. Bolts that are stretched more than .007 are usually discarded. A complete set of 16 bolts can be checked in less than 60 seconds. Might just be the best minute you invested in your engine assembly.



T-1128 **\$65**

Rod-Piston Pusher

Here is a tool that allows one to safely and quickly install or remove the rod-piston combo out of the block. The pointed end of The Pusher is simply inserted into one of the two threaded holes in the connecting rod. The bend in the shaft allows easy navigation around the crankshaft journal. The diver with hot oil dripping onto his face will thank you profusely.

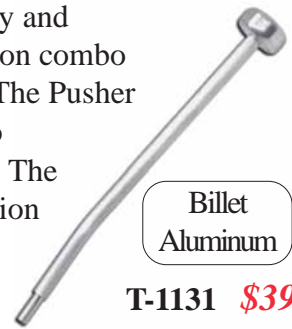

Billet Aluminum

T-1131 **\$39**

Magneto Wrench

Designed to very quickly and safely remove the drive from a Mallory or MSD magneto/ Distributor. It simply slips over and holds the 4-Pin or Hex Cross Drive so that one can remove the inner nut. No need to remove the magneto cap and hold the rotor. Ditto for installing the drive.



T-1017 **\$24**



Spark Plug T-Wrench

Save time and head damage. This torque wrench only allows the spark plug to tighten to a pre-determined safe setting. Machined from billet aluminum for strength & lightweight. Very popular among Top Fuel & Alcohol teams.

13/16
T-1003
\$145

The Gapper

Quickly, precisely and accurately gap spark plugs. Billet Alum.

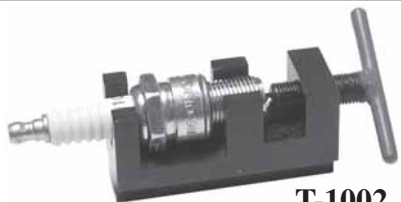

T-1002 **\$59**

Spark Plug Storage Rack

Heavy-Duty, yet lightweight rack is designed to store 8 spark plugs safely and in order. Large flat anodized bottom keep the rack upright and easily cleans up. Can be used stand-alone or bolted to a work bench. Those that assemble the engine top end will truly appreciate this rack regardless if they're at the shop or in the pits.



T-1136 Holds 8 **\$39**
T-1138 Holds 16 **\$47**

Valve Train Trays

These trays are made of a very light-weight yet rigid plastic material with built-in handles. The valve tray holds valve springs, valve locks, and the largest of valves. The rocker tray holds push rods, lifters, poly locks, spark plugs and rocker arms. Perfect for the home mechanic or pro racer.



\$29



JAZ-735-001-06 Valve & Spring
JAZ-735-002-06 Rocker Arm & Lifter

Billet Primer Bottle Top

Machined from billet alum and precisely drilled to allow correct flow of fluid during priming of a blown alcohol or nitro engine. Fits most plastic bottles. Used by the Pros.



\$29

T-1005

Rack 'em Up

Piston & Rod

Safely hold and protect a complete set of Pistons & Rods during assembly. A must for the serious racer.



\$154

T-3003

Head Repair

Here's a great rack to store your Valves, Lash Caps, Shims & Retainers during head repairs. Sturdy billet anodized aluminum bottom tray.



\$129

T-3009



Lifter/ Push Rod

Just set this tray in your lifter valley and store your pushrods & lifters in order.



\$114

T-3013

Clutch Loading Rack

This rack is heavy-duty yet lightweight, Holds 5 discs and rotors. Designed by a racer for racers.



\$109

T-3005

Injector Hat Tool Tray

Injector Hat Tool Tray is made from high grade aluminum and black powder coated for an attractive long-lasting finish. The tray has plenty of space for tools & also accommodates 16 spark plugs. Fits on top of Bug, Bird & Buzzard.



\$129

OLS-TT600

Same Day Shipping!

800/576-7661

Quick-Connect Burndown Tubes



Hemi
C-7152

Accepted by:
NHRA & IHRA

- * Anodized Aluminum
- * Positive Locking
- * Heat Treated Flanges

\$153
Set



All Others
C-7150

1.25" Clear Hose
B-5125... **\$5/ft**



PS Anglia-Style Boulton Spindle Kits

CNC machined and double-lock on steering arm to ensure against movement.

Billet Steel. 2" King pin bosses.

**Dragsters & Altered,
Funny Cars**

Complete with:

Pins, 2 Arms, Caps & Grade 8 Hardware. C-7107 6" Arm **\$ 29**



C-7103 Spindles **\$319/ Set**



Professional Oil Filters



A

Spin-On aluminum filter features a re-usable Stainless Steel element. Very easy to inspect oil.

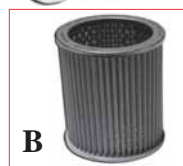

B

Remote Mounts and Block Adapters

Machined from Billet alum and anodized. Available in AN10 or AN12.



C



D



F

- A. SYS-209-312361 Oil Filter 4.25" **\$ 148**
- A. SYS-211-510571 Oil Filter 6.37" **\$ 179**
- B. Replacement SS Element 6.375" **\$ 59**
- C. SYS-221-90004 Remote Mount **\$ 145**
- D. SYS-220-90006 Remote 1.50" **\$ 172**
- E. SYS-228-90556 Block Adapter **\$ 199**

FC/Altered Front Brake Kits



Designed for the PS/Anglia style spindle popular on Funny Cars and Altered.

\$ 539

Front Brake Kit

Includes Mounting Hardware!

In-line Residual Valves retain a minimum line pressure (2 psi) to eliminate excessive pedal travel.



Wilwood Master Cylinders are High Pressure die-cast from High-Grade Aluminum, fully machined and assembled with exclusive features.



We Specialize in Drag Racing Brakes



- W-260-4894 Master Cylinder Dual **\$118.98**
- W-260-6764 Master Cylinder 3/4" **\$ 57.98**
- W-260-6765 Master Cylinder 7/8" **\$ 57.98**
- W-260-6766 Master Cylinder 1" **\$ 57.98**
- W-260-1874 Residual Valve 2psi **\$ 17.98**
- W-120-2498 Front Caliper Dynalite **\$ 92.85**
- W-120-6818 Rear Caliper Dynalite **\$124.95**
- W-150-1251K Front Pads Round Spot **\$ 32.98**
- W-150-8937K Front Pads Square **\$ 39.98**
- W-150-8850K Rear Pads **\$ 42.98**
- W-140-3326 FC/Altered Front Brake Kit ... **\$539.99**



Premium Heavy-Duty Chassis Tabs

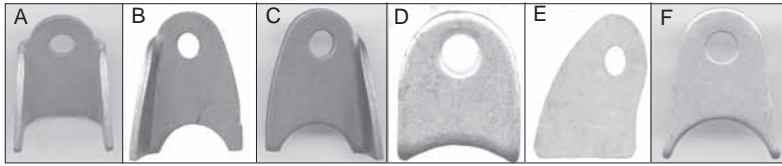

Carbon Steel 1/8 Thick

A	C-8152 Double Sided 3/8 hole ..	\$ 4.99
	C-8152.5 5 Pack	\$23.99
B	C-8150L Single Sided LH	\$ 4.99
	C-8150L.5 5 Pack	\$23.99
C	C-8150R Single Sided RH	\$ 4.99
	C-8150R.5 5 Pack	\$23.99
D	C-8154 Universal 3/8 hole	\$ 1.99
	C-8154.5 5 Pack	\$ 7.99

Over 97 % of
all race parts
sold by Good
Vibrations
Products are
Proudly made
in the USA!

Chromoly 1/8 Thick

A	C-8186 Double Sided 3/8 hole ...	\$ 7.99
	C-8186.5 5 Pack	\$36.99
F	C-8182 Universal 3/8 hole	\$ 5.99
	C-8182.5 5 Pack	\$27.99



Hi-Quality Rod Ends

Male & Female
Left & Right Hand



Female Right Hand

CREF-3-3	10-32	\$7.99
CREF-4-4	1/4-28	\$6.99
CREF-5-5	5/16-24	\$7.99
CREF-6-6	3/8-24	\$7.99
CREF-7-7	7/16-20	\$8.99
CREF-8-8	1/2-20	\$9.99

Male Right Hand

CREM-3-3	10-32	\$6.99
CREM-4-4	1/4-28	\$6.99
CREM-5-5	5/16-24	\$7.99
CREM-6-6	3/8-24	\$7.99
CREM-7-7	7/16-20	\$8.99
CREM-8-8	1/2-20	\$9.99

Female Left Hand

CREF-3L-3	10-32	\$7.99
CREF-4L-4	1/4-28	\$6.99
CREF-5L-5	5/16-24	\$7.99
CREF-6L-6	3/8-24	\$7.99
CREF-7L-7	7/16-20	Call
CREF-8L-8	1/2-20	Call

Male Left Hand

CREM-3L-3	10-32	\$6.99
CREM-4L-4	1/4-28	\$6.99
CREM-5L-5	5/16-24	\$7.99
CREM-6L-6	3/8-24	\$7.99
CREM-7L-7	7/16-20	\$8.99
CREM-8L-8	1/2-20	\$9.99

Don't trust your Race Car to inferior brands

Premium DZUS Fasteners

A	C-83010 Steel .550 Button	\$ 1.55
	10 Pack	\$13.95
B	C-83013 Steel Backing Plate	\$.65
	10 Pack	\$ 5.95
C	C-83015 Steel Spring	\$.70
	10 Pack	\$ 6.95
D	C-83017 Doubler Round	\$.85
	10 Pack	\$ 7.95
E	C-83018 Doubler Square	\$.85
	10 Pack	\$ 7.95



F	C-83020 SE Button Assy	\$ 2.20
	10 Pack	\$19.95
G	C-83023 SE Backing Plate	\$.65
	10 Pack	\$ 5.95
H	C-83025 SE Steel Spring	\$.70
	10 Pack	\$ 6.95



	Dimpling Tool Professional way to dimple your sheet metal for DZUS. C-83005	\$18
--	--	-------------

	\$10 DZUS Wrench C-83007
---	--



Installation
Video



Self
Ejecting
DZUS
(SE)

Zoomie Headers Weld-Up Kits

.065 Wall Thickness
Includes Flanges!

Dragster

(Single Wall)

2.00" SBC	\$375
2.50" BBC	\$395
2.50" Hemi	\$450

FC/ Altered

(Double Wall)

2.25" Hemi 392	
2.50" BBC & Hemi	
	\$ 475 Kit



AN Thread Sizes

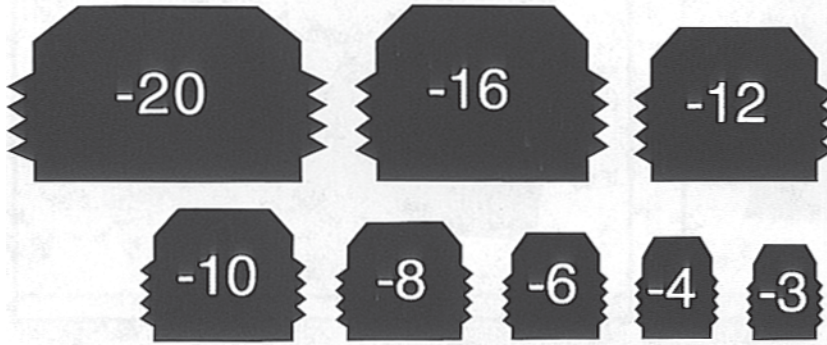

AN Size	Metal Tube O.D.	Thread Size
4	1/4"	7/16-20 UNJ
6	3/8"	9/16-18 UNJ
8	1/2"	3/4-16 UNJ
10	5/8"	7/8-14 UNJ
12	3/4"	1-1/16-12 UNJ
16	1"	1-5/16-12 UNJ
20	1-1/4"	1-5/8-12 UNJ

NPT Thread Sizes

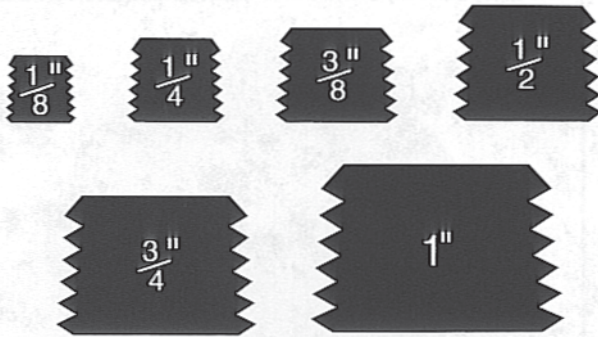

Pipe Thread Size	Threads Per Inch	Fitting I.D.	Closest AN Fitting Size
1/8"	27	1/8"	4
1/4"	18	1/4"	6
3/8"	18	3/8"	8
1/2"	14	1/2"	10
3/4"	14	3/4"	12
1"	11-1/2	1"	16
1-1/4"	11-1/2	1-1/4"	20

Bulkhead Nut Sizes

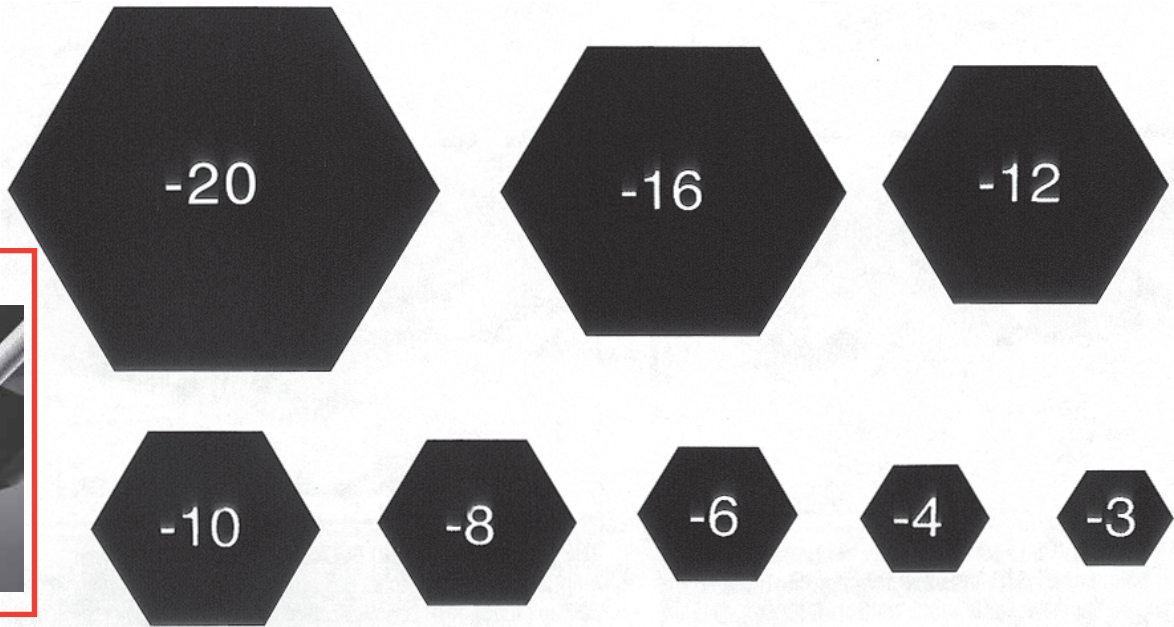

Plumbing Catalog

80 pages of plumbing technical data and photos.



FREE with Purchase!

Aluminum AN Weld Bungs

Female

AN6	X-987106	\$ 9.57
AN8	X-987108	\$ 10.15
AN10	X-987110	\$ 11.99
AN12	X-987112	\$ 12.37
AN16	X-987116	\$ 19.99

Male

X-997106	\$ 3.76
X-997108	\$ 4.99
X-997110	\$ 5.86
X-997112	\$ 9.96
X-997116	\$ 12.90

Alum Female Pipe Weld Bungs

Hex

3/8"	X-996703	\$ 4.99
1/2"	X-996704	\$ 5.88
3/4"	X-996706	\$ 8.40
1"	X-996708	\$ 9.96

Round

X-996803	\$ 3.55
X-996804	\$ 3.89
X-996806	\$ 4.06
X-996808	\$ 4.64

Hose Fitting Assembly

Online Assembly

1. Wrap hose tightly with tape at cutting point. Using a fine tooth hacksaw, cable cutters or radiac wheel, cut the hose in the middle of the tape. Remove tape after cutting being careful not to fray the braid.

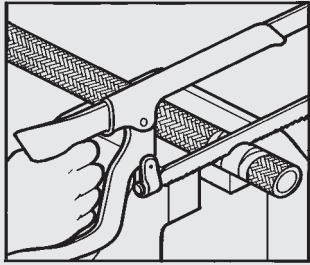

2. Slip hose into socket to the depth indicated by the hose insertion mark on the outside of the socket. This should be just short of the back of the threads. **VERY IMPORTANT** - Mark hose with tape or suitable marking device at rear of socket. This mark will later indicate to you if the hose has pushed out of the socket during assembly.

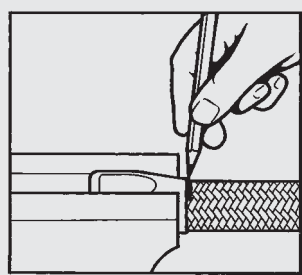

3. Using an anti-seize lubricant, liberally lubricate inside of hose and threads on the nipple. Holding nipple horizontally in a vise equipped with soft aluminum jaws, push socket end carefully with hose nipple with a turning motion and engage nipple threads into those of the socket. Continue tightening by hand as far as possible to make sure that the threads are properly mated and no cross threading has occurred.

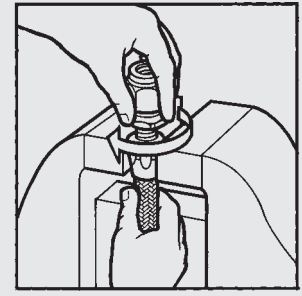

4. Using an aluminum fitting wrench, finish tightening assembly. When properly assembled a small gap of .030" or less should exist between the socket and shoulder of nipple. **NOTE:** Check marks on hose in step 2 for any evidence of push out. Hose assembly must be cleaned and tested to twice the operating pressure.

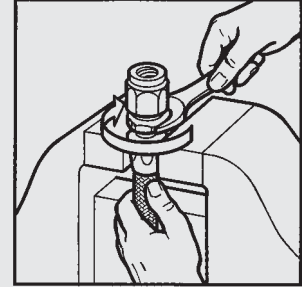

Aluminum Vice Jaws

Vice Jaw inserts protect your hose ends during assembly. Each jaw has magnetic backing to prevent them from falling out of the vice when opened.

X-821010 **\$19**

No more Bloody Fingers!

Assemble Braided Stainless Steel hose without poking your fingers. Ideal for racers and performance enthusiasts who have experienced the painful challenge of installing the AN socket.



How-To Demo



- KT-468** 3pc Kit AN4-6-8 **\$ 74**
- KT-681** 3pc Kit AN6-8-10 .. **\$ 79**
- KT-1016** 3pc Kit AN10-12-16 **\$ 89**
- KT-416** 6pc Kit AN4-16 **\$149**



Award Winner
SEMA Show

Teflon Hose Separating Tool



\$36

Easiest way to assemble braided stainless steel AN3 & AN4 teflon hose.

X-821060

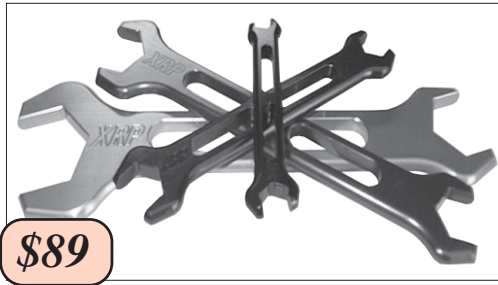

\$89



Professional Aluminum Wrenches

Precisely sized for a perfect fit on AN fittings. Anodized in colors, XRP wrenches are fully radiused to fit your hand. Machined from heat treated 2024 aluminum alloy.

X-750000 AN3-20

Building a Better World for Children

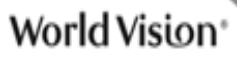

A portion of your sale will be contributed to this noble cause. If you would like to learn more about this worldwide charity, please goto:

www.worldvision.org

Same Day Shipping!

800/576-7661



Why Use CPE Braided SS Hose ??

Used by Top Teams everywhere, Stainless Steel braid provides durability and Heat Resistance. Inner liner is composed of Chlorinated Polyethylene (CPE) which provides the finest fluid transfer available with a temperature range of -40 degrees to +300 degrees F.



Fixed

AN-4	100004..	\$ 7.16
AN-6	100006..	\$ 7.63
AN-8	100008..	\$ 9.61
AN-10	100010..	\$12.57
AN-12	100012..	\$17.19
AN-16	100016..	\$26.43
AN-20	100020..	\$41.70

Straight



Want Black Fittings? Same Price!

Simply add .BB to end of the part number :)

Swivel Ends allow one to position hose end after it has been installed on hose.

Fixed

AN-4	104504...	\$ 17.10
AN-6	104506...	\$ 18.46
AN-8	104508...	\$ 21.79
AN-10	104510...	\$ 25.80
AN-12	104512...	\$ 31.13
AN-16	104516...	\$ 39.65
AN-20	104520...	\$ 74.69

45 Degree



Swivel

AN-6	204506....	\$ 20.53
AN-8	204508....	\$ 24.08
AN-10	204510....	\$ 28.04
AN-12	204512....	\$ 33.57
AN-16	204516....	\$ 42.15
AN-20	204520....	\$ Call

Fixed

AN-4	109004....	\$ 17.10
AN-6	109006....	\$ 18.46
AN-8	109008....	\$ 21.79
AN-10	109010....	\$ 25.80
AN-12	109012....	\$ 31.13
AN-16	109016....	\$ 39.65
AN-20	109020....	\$ 74.69

90 Degree



Swivel

AN-6	209006....	\$ 20.13
AN-8	209008....	\$ 24.75
AN-10	209010....	\$ 28.04
AN-12	209012....	\$ 33.64
AN-16	209016....	\$ 42.15
AN-20	209020....	\$ Call

Fixed

AN-4	118004....	\$ 21.84
AN-6	118006....	\$ 23.35
AN-8	118008....	\$ 26.88
AN-10	118010....	\$ 29.73
AN-12	118012....	\$ 33.72
AN-16	118016....	\$ 44.87

180 Degree



Swivel

AN-6	218006....	\$ 23.08
AN-8	218008....	\$ 27.30
AN-10	218010....	\$ 30.68
AN-12	218012....	\$ 38.06
AN-16	218016....	\$ 55.93

Want BLACK Hose?

XR-31 for the same price as Braided SS hose!



XR-31 Hose is tough, yet lightweight, durable, abrasion-resistant and economical. 3 ply construction. High tube strength allows a tight bend radius capable for tight engine compartments.

Uses the same Hose Ends as the Braided SS Hose

AN-4	\$ 6.35/ft
AN-6	\$ 6.90/ft
AN-8	\$ 7.90/ft
AN-10	\$ 8.90/ft
AN-12	\$10.90/ft
AN-16	\$11.90/ft
AN-20	\$16.90/ft

NHRA/ IHRA Accepted

Braided SS TEFLON Hose

Braided Stainless Steel TEFLON Hose and Reusable Hose Ends are used in Brake, Clutch, Instruments and other applications where max high pressure protection is a must.



AN-3	X-610003...	\$ 3.20/ft
AN-4	X-610004...	\$ 3.83/ft

TEFLON Hose Ends



Steel



Str
45
90

AN-3	X-600003 ..	\$ 6.25
AN-4	X-600004 ..	\$ 5.85
AN-3	X-604503 ..	\$ 10.95
AN-4	X-604504 ..	\$ 10.95
AN-3	X-609003 ..	\$ 10.95
AN-4	X-609004 ..	\$ 10.95

TEFLON Hose Assembly



We stock Pre-Assembled AN3 & AN4 Braided SS Teflon Hose Assemblies. Straights or 90 Deg Ends.

Lengths: 12" - 50"

from.. \$10

Hose Ends also Available in: 30, 60, 120 & 150 Degree



Tube Nuts



AN-3	X-981803...	\$.91
AN-4	X-981804...	\$.91
AN-6	X-981806...	\$ 1.19
AN-8	X-981808...	\$ 1.73
AN-10	X-981810...	\$ 2.49
AN-12	X-981812...	\$ 3.36
AN-16	X-981816...	\$ 5.38

Works on
Steel or
Aluminum
Hard Line.

Tube Sleeves



X-981903...	\$.95
X-981904...	\$.95
X-981906...	\$ 1.19
X-981908...	\$ 1.35
X-981910...	\$ 2.08
X-981912...	\$ 3.38
X-981916...	\$ 3.85

Hose Finishers



Anodized Alum.
Includes SS
Worm Clamp

Red
Blue
Black

AN4	X-550104	\$ 4.34
AN6	X-550106	\$ 4.34
AN8	X-550108	\$ 4.62
AN10	X-550110	\$ 5.53
AN12	X-550112	\$ 6.49

Hex Pipe Plug

Internal hex for smooth
finish and easy installation.



1/8	X-993202 (pr)	\$ 2.43
1/4	X-993203 (pr)	\$ 2.43
3/8	X-993204 (pr)	\$ 3.08
1/2	X-993205	\$ 3.26
3/4	X-993206	\$ 4.20

EPR O-Rings

Long Lasting - Won't Shrink

X-803003	AN3	\$ 3.66
X-803004	AN4	\$ 4.18
X-803006	AN6	\$ 5.01
X-803008	AN8	\$ 5.01
X-803010	AN10	\$ 7.89
X-803012	AN12	\$ 7.89
X-803016	AN16	\$ 4.50*
X-803020	AN20	\$ 6.20*



Ideal for
Gas,
Alcohol
& Nitro

* packs of five

AN Flare Reducers



Female - Male

AN6-4	X-995006	\$ 6.79
AN8-6	X-995008	\$ 7.75
AN10-6	X-995010	\$ 8.68
AN10-8	X-995011	\$ 8.68
AN12-8	X-995012	\$ 10.33
AN12-10	X-995013	\$ 10.33
AN16-12	X-995017	\$ 27.74



Flare Plug



Port Plug



Flare Cap



Hex Nut

AN-3	X-980603...	\$ 1.40	X-981403...	\$ 1.73	X-992903...	\$ 1.84	X-992403...	\$.91
AN-4	X-980604...	\$ 1.40	X-981404...	\$ 2.07	X-992904...	\$ 2.15	X-992404...	\$.91
AN-6	X-980606...	\$ 1.40	X-981406...	\$ 2.10	X-992906...	\$ 3.48	X-992406...	\$ 1.03
AN-8	X-980608...	\$ 2.61	X-981408...	\$ 3.34	X-992908...	\$ 4.13	X-992408...	\$ 2.00
AN-10	X-980610...	\$ 3.36	X-981410...	\$ 5.04	X-992910...	\$ 5.06	X-992410...	\$ 2.07
AN-12	X-980612...	\$ 5.01	X-981412...	\$ 7.44	X-992912...	\$ 6.79	X-992412...	\$ 2.36
AN-16	X-980616...	\$ 6.42	X-981416...	\$ 9.49	X-992916...	\$ 8.75	X-992416...	\$ 4.69

Flare Adapters

AN-3	981503	\$ 2.71	AN Flare
AN-4	981504	\$ 2.71	Coupler
AN-6	981506	\$ 2.71	
AN-8	981508	\$ 4.81	
AN-10	981510	\$ 5.60	
AN-12	981512	\$ 10.87	
AN-16	981516	\$ 17.51	



4-3	991902	\$ 4.13	
6-4	991906	\$ 4.24	AN Flare
8-6	991912	\$ 5.93	Reducer
10-6	991914	\$ 8.68	
10-8	991915	\$ 8.42	
12-8	991919	\$ 13.04	
12-10	991920	\$ 13.04	
16-10	991922	\$ 16.95	
16-12	991923	\$ 16.95	
20-12	991925	\$ 23.65	
20-16	991926	\$ 27.95	



Flare to Pipe Adapters



Straight



45 Degree



90 Degree

Flare - Pipe

AN-3.....1/8	981603	\$ 2.28	982303	\$ 7.26	982203	\$ 7.26
AN-4.....1/8	981604	\$ 2.28	982304	\$ 7.39	982204	\$ 7.39
AN-6.....1/4	981606	\$ 2.45	982306	\$ 7.60	982206	\$ 7.60
AN-6.....3/8	981666	\$ 3.17	982366	\$ 10.20	982266	\$ 10.20
AN-8.....1/4	981607	\$ 3.29	982307	\$ 13.04	982207	\$ 13.04
AN-8.....3/8	981608	\$ 3.29	982308	\$ 9.22	982208	\$ 9.22
AN-8.....1/2	981688	\$ 4.81	982388	\$ 14.67	982288	\$ 14.67
AN-10....1/2	981610	\$ 4.88	982310	\$ 14.67	982210	\$ 14.54
AN-10....3/4	981613	\$ 9.12	982313	\$ 21.72	982213	\$ 21.72
AN-12....3/4	981612	\$ 9.12	982312	\$ 21.72	982212	\$ 21.72

Stainless Steel Tubing

Great for plumbing your
Brake, Fuel or Fire System.

E-ST18 3/16 \$ 5.99/ft

E-ST25 1/4

E-ST37 3/8 \$7

Seamless!!



Same Day Shipping!

800/576-7661

Male Flare to Female Swivel Tee



AN4	X-900304....	\$ 13.67
AN6	X-900306....	\$ 16.92
AN8	X-900308....	\$ 24.73
AN10	X-900310....	\$ 29.94
AN12	X-900312....	\$ 31.24
AN16	X-900316....	\$ 84.12



Fuel Pressure Take Off Adapters



Tapped
1/8 pipe
on the
Hex



X-700192	-6 Male to -6 Male	\$ 8.33
X-700194	-6 Male to 3/8" Male NPT	\$ 8.33
X-700195	-6 Male to -6 Female Swivel	\$ 9.77
X-700196	-8 Male to -8 Male	\$ 9.73
X-700198	-8 Male to 3/8" Male NPT	\$ 9.73
X-700199	-8 Male to -8 Female Swivel	\$ 11.57
X-700202	-10 Male to -10 Female Swivel	\$ 14.89

Female Swivel Coupler



AN6	X-900106	\$ 6.63
AN8	X-900108	\$ 8.14
AN10	X-900110	\$ 9.89
AN12	X-900112	\$ 13.86
AN16	X-900116	\$ 19.29



Female Swivel Coupler - 90 Deg

AN4	X-929004 ...	\$ 13.30
AN6	X-929006 ...	\$ 13.30
AN8	X-929008 ...	\$ 14.98
AN10	X-929010 ...	\$ 18.99
AN12	X-929012 ...	\$ 20.48
AN16	X-929016 ...	\$ 47.26

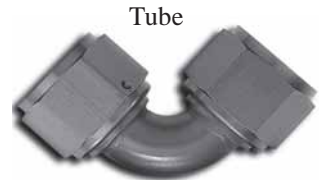

Tube

AN6	X-929106 ...	\$ 14.26
AN8	X-929108 ...	\$ 15.09
AN10	X-929110 ...	\$ 19.27
AN12	X-929112 ...	\$ 24.94
AN16	X-929116 ...	\$ 42.22



Forged

Liquid Filled Pressure Gauge

Great for *Oil* or *Fuel Pressure*, or *Blower Boost*. Liquid filled for stability and longevity.



X-710000	0-15psi	Shock
X-710030	0-30psi	Resistance
X-710060	0-60psi	
X-710100	0-100psi	

1.50in Diameter

\$39



Carburetor Line Kit



Gauge
Sold
Separately

Braided Stainless Steel
Multiple Sizes and
Styles Available.

As low as .. **\$ 64**



Carb Fittings

Dual Feed Holley		
X-700106	AN6 to 7/8-20	\$ 7.30
X-700128	AN8 to 7/8-20	\$ 10.94

Single Feed AN6		
X-700006	9/16-24 Holley	\$ 5.78
X-700306	5/8-20 Carter	\$ 5.78

Fittings Include Washers

Stainless Steel Dual Carb Plumbing Kits
See Page 21

Gauge Fittings

Connect your
Gauges to AN
Hoses



X-705003	STRT to 1/8 Fem NPT AN3	\$ 5.27
X-705004	STRT to 1/8 Fem NPT AN4	\$ 2.05
X-705093	90 Deg to 1/8 Fem NPT AN3	\$ 5.16
X-705090	90 Deg to 1/8 Fem NPT AN4	\$ 3.66

Swivel AN to Male Pipe



AN3 - AN12
1/8 to 3/4 NPT



Anodized Black

What are AN ORB Adapters?

Male AN Flare to Inverse Male AN with an O-Ring.



High Contour Flow



Female to Male Swivel Adapters

Sizes: AN4 -16



45 & 90 Degrees



Tube



Forged

Straight

AN3	E-815-3A	\$ 4.75
AN4	X-980004	\$ 5.71
AN6	E-815-6	\$ 4.81
AN8	E-815-8	\$ 6.28
AN10	E-815-10	\$ 7.95
AN12	E-815-12	\$ 9.95
AN16	E-815-16	\$ 14.95
AN20	E-815-20	\$ 19.95

45 Degree

X-984503	n/a
X-984504	\$ 9.95
X-984506	\$ 13.35
X-984508	\$ 15.30
X-984510	\$ 23.10
X-984512	\$ 34.81
X-984516	\$ 43.95
X-984520	\$ 58.95

90 Degree

X-989003	\$ 12.95
X-989004	\$ 9.95
X-989006	\$ 11.95
X-989008	\$ 13.74
X-989010	\$ 21.39
X-989012	\$ 32.88
X-989016	\$ 43.85
X-989020	\$ 88.08

Reducer



E-919-6-8	\$ 7.99
E-919-6-10	\$ 9.99
E-919-8-10	\$ 9.99
E-919-8-12	\$ 12.99
E-919-10-12	\$ 12.99
E-919-12-16	\$ 18.99
E-919-16-20	\$ 23.99

Anodized aluminum ORB Reducers are designed to reduce the inverse flare ORB side to a smaller male AN size. O-ring and inverse flare will be on the larger AN side.

Expander



E-919-8-6	\$ 7.99
E-919-10-8	\$ 7.99
E-919-12-8	\$ 12.99
E-919-12-10	\$ 12.99
E-919-16-8	\$ 18.99
E-919-16-12	\$ 18.99
E-919-20-16	\$ 23.99

Anodized aluminum ORB Expanders are designed to expand the inverse flare ORB side to a larger male AN size. O-ring and inverse flare will be on the smaller AN side.



Aluminum Bung with Steel Cap.

X-821015 \$28.99

Pursosil Hose



Ideal for Fuel Line from Tank to Pump

XRP's silicone Pursosil preformed hose has a maximum operating temperature of 350°. Popular on Top Alcohol Fuel Systems.

90 Deg Bend

X-390125	1.25 ID	\$ 44.50
X-390175	1.75 ID	\$ 50.28
3ft Straight - Coolant		
X-370125	1.25 ID	\$ 55.14
X-370125	1.75 ID	\$ 68.50

Push-On Hose & Ends



Hose From.. **\$3.57/ft**
CPE elastomer tube, textile braid reinforced with CPE elastomer cover.
Maximum operating temperature of 250°. Ideal for fuel, lubricating oil, air & water.



Str



90

AN4	X-230004	\$ 4.57
AN6	X-230006	\$ 4.57
AN8	X-230008	\$ 5.44
AN10	X-230010	\$ 7.33
AN12	X-230012	\$ 11.95
<hr/>		
AN4	X-239004	\$ 15.19
AN6	X-239006	\$ 16.29
AN8	X-239008	\$ 19.55
AN10	X-239010	\$ 22.40
AN12	X-239012	\$ 26.64

Hose & Fittings: Blue or Black

Also in Stock: 30 45 60 120 150 180 Degrees



Accu-Seal Gaskets

Accu-Seal is the first choice of engine builders and race teams. The **Accu-Seal E** gasket line delivers precision fit, durability and economy all in one. **Accu-Seal Pro** utilizes state-of-the-art materials such as *proprietary steel core laminate with teflon coating, viton oil seals, and molded rubber* for selected Oil Pan and Valve Cover applications.

p/n: **Regular** = 1xxxxxx **Pro** = 2xxxxxx

Intake Gaskets

- SCE-111101 SBC 1.20 x 2.00 Port \$ 12.95/pr
- SCE-111102 SBC 1.25 x 2.275 Port \$ 12.95/pr
- SCE-111103 SBC 1.25 x 2.275 (1266) Thick \$ 16.95/pr
- SCE-113102 BBC 1.8 x 2.5 \$ 12.95/pr
- SCE-113115 BBC 1.8 x 2.5 No Top bolt \$ 12.95/pr
- SCE-113116 BBC 1.8 x 2.5 No Top bolt. Thick \$ 17.95/pr
- G-2210 426 Hemi Stock Port 2.375 \$ 17.98/pr
- G-2212 426 Hemi Medium Port 2.750 \$ 17.98/pr
- G-2218.10 Hemi/BAE/TFX End Rail Gaskets \$ 8.50/10pk



SCE-113102



SCE-111101
SCE-111102
SCE-111103



SCE-113115
SCE-113116



G-2210
G-2212

Silicone Ports

- SCE-211101 SBC 1.20 x 2.00 Port (1256) ... \$ 16.95/pr
- SCE-211102 SBC 1.25 x 2.20 Port (1205) ... \$ 17.95/pr
- SCE-211128 SBC 1.30 x 2.24 Port (1206) ... \$ 17.95/pr
- SCE-213102 BBC 1.80 x 2.50 Port (1211) .. \$ 19.95/pr
- SCE-213115 BBC 1.80 x 2.50 Port (1275) .. \$ 16.95/pr
- SCE-218101 Big Chief/ bigDuke (1298) \$ 19.95/pr



SCE-211128



SCE-213102



SCE-218101



SCE-213115



Oil Pan Gaskets

Superb Quality - Reusable
Gas - Alcohol - Nitro

PREMIUM -Street/ Strip

- SCE-111091 SBC Pre 1974 Thin Front Seal \$ 12.95
- SCE-113090 BBC .090 Thick \$ 12.95
- SCE-235091 BB Ford 1pc Molded \$ 32.95
- SCE-113091 KB Olds .090 Thick \$ 15.95
- SCE-113092 Merlin Block, Large Stroke \$ 15.95
- SCE-167091 417 Hemi \$ 14.95
- G-2110 426 Hemi, KB, BAE \$ 11.95
- G-2114 TFX-92 \$ 11.95
- G-2118 TFX-96 \$ 11.95

PROFESSIONAL Steel-Core & Teflon Coated

- SCE-274090 481X Rodeck \$ 27.95
- SCE-266091 KB BAE Hemi \$ 29.95
- SCE-261091 TFX 92 Hemi \$ 32.95
- SCE-261093 TFX 96 Hemi \$ 32.95

Simply
the Best.
Period.

Engine Seals



	Front	Rear Viton
SB Chevy	SCE-11102 \$ 3.95	SCE-21105 \$19.95
BB Chevy	SCE-11302 \$ 7.95	SCE-21305 \$24.95
351W	SCE-13602 \$ 7.95	SCE-23605 \$14.95
BB Ford	SCE-13502 \$ 7.95	SCE-23505 \$21.95
SB Mopar	SCE-16902 \$ 7.95	SCE-16904 \$ 9.95
BB Mopar	SCE-16402 \$ 7.95	SCE-26405 \$19.95
417 Hemi	SCE-16702 \$ 7.95	SCE-13405 \$19.95
426 Hemi	SCE-16602 \$ 7.95	SCE-26605 \$23.95

Looking for Blower Gaskets?



See
Page 17





Valve Cover Gaskets

PREMIUM Rubber with Steel Core



- G-2320 SB Chevy \$ 12.95
- G-2325 BB Chevy \$ 14.95
- G-2330 SB Ford \$ 12.95
- G-2335 351C Ford .. \$ 14.95
- G-2340 428 Ford \$ 14.95
- G-2345 429-460Ford \$ 14.95
- G-2305 SB Mopar \$ 14.95
- G-2355 330-455 Olds \$ 14.95
- G-2350 Pontiac \$ 14.95



Re-usable

STREET/STRIP Laminated Cork/ Silicone

- SCE-211075 SB Chevy \$ 19.95/pr
- SCE-213075 BB Chevy .125 \$ 23.95/pr
- SCE-213076 BB Chevy .250 \$ 27.95/pr
- SCE-267076 Hemi Early \$ 29.95/ea
- G-2310 426 Hemi \$ 11.47/ea

PROFESSIONAL Steel-Core & Teflon Coated

- SCE-213078 BB Chevy
- SCE-218078 Big Chief
- SCE-266075 KB BAE 1/4 holes
- SCE-261075 KB BAE 5/16 holes
- SCE-267077 Hemi Early



\$ 34.95/pr

Superb Quality - Reusable
Gas - Alcohol - Nitro

Front Cover



Includes Timing Cover,
Water Pump & Fuel
Pump Gaskets

- SCE-11100 SB Chevy
- SCE-11300 BB Chevy
- SCE-13600 SB Ford
- SCE-13500 BB Ford
- SCE-16900 SB Mopar
- SCE-16400 BB Mopar
- SCE-16600 426 Hemi

\$6.95ea

Thermosplastic Carb Gaskets



Molded Bowl Carb gasket is made from a non-stick thermoplastic material that is resistant to all motor fuels, racing fuels, and additives common to racing. Designed for **4150/4160** Holley carburetors. Has precision fuel and air passages for better consistency. Will not shrink, stick or tear, thus eliminating scraping. Gasket is reusable.
Patent Pending.

Will NOT Shrink !
Will NOT Stick !
Will NOT Tear !
\$ 8.95/pr

Ask about our 10pk Discount

BOWL Gasket
SCE-411 4150
SCE-451 4500

METERING Gasket
SCE-410 4150
SCE-450 4500

Award Winner
SEMA Show



Holley Carb gaskets are heat resistant and standard thickness. Will handle the rigors of **supercharged** engines.



- G-2070 Carb Gasket \$ 3.25
- G-2072 Dom Gasket \$ 3.25
- SCE-355 4 Port Gasket \$ 3.25



Customer's Ride



Alfio Sciacco -Windsor Downs, Australia

Copper Head Gaskets

Benefits of Using Copper...

Conductivity. Copper is the standard by which all other conductors are measured, therefore a copper gasket provides superior thermal conductivity, acting to stabilize head and block temperatures which makes tuning easier.

25% Coefficient of Elasticity. One of the properties of copper is that it stretches before a catastrophic failure, thereby providing an extra measure of safety in case of severe detonation.

Strength. Copper (in the form SCE use) has a tensile strength of approximately 32,000 psi, compare this to the 1200 to 1800 psi tensile of most facing materials used on conventional performance head gaskets.

Premium Quality * Properly Annealed
Perfect Fit * Dead Soft Copper

- .032 \$ 89/pr
- .043 \$ 89
- .050 \$ 99
- .062 \$ 109
- .070 \$ 179
- .080 \$ 139



O-Ring Wire
304 Stainless Steel
SCE-31541 15ft **\$10.95**



In Stock: Chevy, Mopar, Ford
*** Reusable ***

Pro-Copper Exhaust Gaskets

SCE Copper Exhaust Gaskets will permanently seal a warped or uneven flange.

Embossed **\$29/pr**
Non-Embossed **\$49**



The World's First Self Sealing Copper Head Gasket!

SCE's TITAN gaskets provides unbeatable strength and user friendly installation. This patented headgasket gives you the best of both worlds: The combustion sealing strength of a SCE copper head gasket and the confidence of **built-in coolant and oil seals!** The perfect racing and performance copper-head gasket!



- .032 **\$129**
- .043 **\$129**
- .050 **\$139**
- .062 **\$149**
- .070 **\$159**
- .080 **\$159**

Sold in Pairs

ICS Copper Head Gaskets

Same as above but with a **Integrated Steel O-Ring** means there is no need to machine your Block or Heads!

Sold in Pairs



No Machining Required!

- .043 **\$169**
- .050 **\$189**
- .062 **\$199**
- .070 **\$219**
- .080 **\$219**

Embedded silicone to seal oil and water passages. Soft copper is ready to use.
Awarded Best New Product at SEMA Show.



Collector Gaskets

Use SCE copper collector gaskets for maintenance free operation.

2.5, 3 and 3.5in **\$11.95/pr**

Billet Gear Drives

- Billet Alum Cover**
- Chromoly Gears**
- Fixed Idler**
- Premium Fasteners**

One of the strongest on the market !

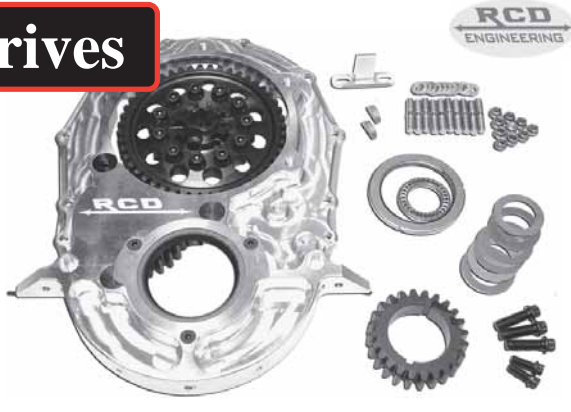

BILLET Gear Drives

RCD-251000-0003 SBC	\$ 899
RCD-251000-0006 SBC w/ BBC	\$ 899
RCD-251000-0009 SBC Tall	\$ 949
RCD-251500-0002 BBC	\$ 899
RCD-251500-0040 KB OLDS	\$1099
RCD-253500-0002 TFX	\$ 899
RCD-253500-0020 KB, BAE	\$ 999
RCD-253500-0040 KB, BAE Tall	\$ 999
RCD-254000-0040 417 Donovan	\$ 999

Gear Drive Components

RCD-300205-0028 Cam Cover (SBC only)	\$ 129
RCD-300205-0032 Cam Cover All Others	\$ 149
B-2121 Cam Cover (KB-BAE-TFX, etc..)	\$ 95
RCD-300209-03 5/8-3/8 Steel Hex Adap	\$ 49
RCD-300207-05 3/8 Steel Shaft 5"	\$ 59
RCD-300201-0032 QR Pump Ext 3 or 5"	\$ 359
B-2125 QR Pump Ext Smooth 5"	\$ 189
B-2126 QR Pump Ext 5" (Fits Non-RCD)	\$ 189



Jesel Belt Drives



- Cam timing adjustment is made externally providing the easiest and most accurate tuning available.
- Billet aluminum Spider is made from 2024-T6 and is available as a solid unit for additional strength.
- Accessories available to run distributor drives, fuel pumps or oil pumps off front of cam.
- Hard coated Billet aluminum 7075 Upper Pulley features patented High Torq Drive™ tooth configuration.
- Teflon® coated high vacuum cam and crank seals.
- Patented High Torq Drive™ reinforced belt operates dry and spins with less friction than timing chains or gear drives and also absorbs harmonics.
- Crank Pulley is heat-treated steel and incorporates a High Torq Drive™ tooth configuration.
- Kit hardware is all Grade 8 Allen and Torx™ head design.



JES-KBD-31000 SBC Standard	\$ 940
JES-KBD-31200 SBC w/ BB Snout	\$1024
JES-KBD-32000 BBC Standard	\$1045
JES-KBD-35000 426-440 Mopar	\$1239

Alum Timing Cover

Polished Aluminum Cover, Gasket, Seal & Chrome Bolts!

ACC-2622 SB Chevy	\$ 29.99
ACC-2632 BB Chevy	\$ 39.99
ACC-2635 BBC Gen 5....	\$ 39.99*
ACC-2636 BBC Gen 6....	\$ 39.99*

* Cover Only

Fixed Single Idler Gear Drive



SBC Polished Alum Cover

\$169

Dual Idler Gear Drive

(Will not fit OEM roller)



ACC-2720 SBC
ACC-2730 BBC

\$99



Motor oils, transmission fluids and gear oils are flowing lubricants that provide a film barrier between metal surfaces pressing or rubbing together. The greater the film strength, the better the oil. However, in extreme pressure metal-to-metal areas, the film strength of oil is seriously thinned and is often completely squeezed out. On the other hand, **Prolong** is a bonding lubricant. **Prolong AFMT™** interacts with metal surfaces in a molecular and chemical process to create a protective buffer on the surface of the metal. This is not a film or coating over the metal. Molecules in the AFMT™ formula are polarized and actually bond with the metal surface. The layer of AFMT™ molecules is activated by extreme pressure and heat, meaning that **Prolong** lubrication performs best right where it is needed most! The result, AFMT™ significantly reduces harmful friction and heat.

Fortified with Prolong's advanced technology, nothing works better than Prolong Oil Stabilizer to help *solve lubrication-related* problems. Other oil stabilizers on the market do not include the necessary additives provided by today's motor oils, such as antioxidants. The formulation of Prolong Oil Stabilizer includes: Prolong's AFMT™ (Anti-Friction Metal Treatment) advanced technology as well as vital additives to provide a completely formulated oil stabilizer product, which sets this product apart from the other competitors. (32oz)

Works great in high horsepower, drag racing engines especially those injected or blown.

Fuel: Gas, methanol, diesel or nitro fuels.

Oil Stabilizer



PSL13032.. \$9.99

Prolong Waterless Wash & Shine is a revolutionary new method of washing and shining your car in less than 15 minutes without water. No buckets, no hoses, no rinsing and drying! Simply spray on the surface and wipe dry. With Waterless Wash & Shine you can conveniently and quickly wash your race or show car anywhere, anytime. The unique formulation dissolves dirt and stains such as tree sap and bugs; special lubricating agents encapsulate the dirt so that it can easily be wiped off a car's delicate surface without scratching. Leaves a protective film that provides gloss, color and smoothness that conventional car washes fail to deliver. (17oz)

Safe & effective on race and show cars.

Wash & Shine



PSL64017.. \$6.99

Product Overview: Reduces electrolysis, extreme pressure friction and excessive heat. **Displaces** moisture and protects metal surfaces. Helps **prevent** corrosion and oxidation. Formulated with unique, AFMT™ advanced technology formula. **How to use:** Add 10% to total volume of oil for gas, methanol, nitro or diesel fueled motors, engines or gear boxes. Add 5% to total volume for hydraulic systems and automatic transmissions. (32oz)

Race proven in most motorsports including: NASCAR, NHRA, Marine & Tractor Pulling

Oil Stabilizer



PSL10010 .. \$35.95

Super Penetrating Lubricant Spray is formulated with AFMT™ (Anti-Friction Metal Treatment) advanced technology to **lubricate**, **penetrate**, and **prevent** corrosion, free sticky mechanisms, **displace** moisture, stop squeaks, and reduce friction and wear on all metal surfaces. **Easy-to-apply** protection and lubrication for hundreds of performance & recreational uses as well as commercial and industrial applications such as light duty machining, tapping and drilling fluid. (16oz)

Ideal for: Enderle & Hilborn fuel pumps, barrel valves & shutoffs.

Lubricant



PSL40016.. \$9.99

*** Preowned Performance Parts ***

Roots Blowers
Pulleys & Belts
Safety Equipment
Magneto Ignitions



Injection Hats
Fuel Pumps
16" Wheels
Zoomie Headers

We pay CASH for good, used race parts

website (www.goodvibesracing.com/Preowned-Parts.htm) 800.576.7661



Open 24/7 at:
GoodVibrationsRacing.com

800/576-7661

Lucas High Performance Racing Motor Oil is a purpose built product designed for the high performance racing industry. It's blended with an exclusive additive package that includes lubricity agents and anti-seize agents that control drag like a zero weight oil and protects metal like a heavy multi-viscosity oil. It is perfect for high RPM & high horsepower Engines. For more specific information on each racing oil please review our product specification sheets.

Racing Oil Key Benefits:

- High Zinc Fortified
- Perfect oil for high RPM engines
- Extra Protection
- Lower Oil Temperature
- Less Drag For More Horsepower!
- Compatible With Methanol Or Racing Gas



Break-in Engine Oil

LOP-10635 20W-50 Oil 1 Qt \$ 7.99

LOP-10636 20W-50 Oil 5 Qt \$ 29.99

Racing Engine Oil

LOP-10620 20W-50 Oil 1 Qt \$ 7.99

LOP-10621 20W-50 Oil 5 Qt \$35.99

LOP-10044 50W Oil 1 Qt \$ 6.99

LOP-10094 50W Oil 2.5 Gal \$73.99

LOP-10265 70W Oil 2.5 Gal \$79.99

Synthetic Engine Oil

LOP-10615 20W-50 Oil 1 Qt \$13.99

LOP-10616 20W-50 Oil 5 Qt \$56.99



Super Coolant

- Lower cylinder head temps
- Allow advanced ignition, timing and more horsepower
- Reduce operating temperatures by up to 20°
- Prevents corrosion, electrolytes and deposits that cause leaks, overheating, and cooling system failures

LOP-10640 Super Coolant 16oz ... \$ 12.99



Transmission Sure Shift

*Smooth, precise shifting * Extraordinary protection*

This is no normal ATF formulation. It has been developed to give the smooth, precise shifts needed by racers and yet extends a degree of protection not found in any other ATF. This product will stop wear and tear like nothing you've ever tried.

LOP-10052 Sure Shift 1 Qt... \$ 6.99



SAFEGUARD™ ETHANOL Fuel Conditioner With Stabilizers

Lucas Safeguard™ was developed to specifically address issues associated with using ethanol based fuels. This applies to E-10, E-15, E-85, pure ethanol and any mixtures in between including gasoline. Safeguard™ is completely soluble in all ethanol fuels and will not harm filters. Contains effective additives to prevent rust and corrosion associated with the use of ethanol fuels. **Treats 80 Gallons**



LOP-10670 Ethanol/Alky Conditioner 5.2oz \$ 5.99

Synthetic Gear Oil

Lucas SAE 75W-90 Synthetic Gear Oil is a non-foaming, super slick, long lasting lubricant designed especially for high performance applications where other gear lubricants just aren't good enough. Contains a special additive package that cushions gears and resists "squeezing out" under extreme pressure situations where other gear lubricants just aren't good enough. Specially designed to stand up to high temperatures without losing its lubricity.



LOP-10043 80W-90 1 Qt Non-Syn .. \$ 8.99

LOP-10047 75W-90 1 Qt Synthetic .. \$ 14.99

Extreme Pressure Valve Train Synthetic Grease

Greatly reduces friction on moving parts to prevent galling. Excellent adhesion quality. Excellent on all surfaces requiring an extreme pressure lubricant. Perfect for assembly lube on rod bolts. Protects pushrod ends on initial start up. Essential for roller lifters, rockers, pushrods and camshafts



LOP-10578 Extreme Pressure Grease \$32.99

Semi-Synthetic Assembly Lube

Lucas High Performance Assembly Lube is designed for mechanics and technicians to pre lube bearings, cams, lifters and valve train. The Semi-Synthetic formula contains ZINC, MOLY and other high pressure additives which offer maximum protection during engine break-in. Super slick and easy to use, Lucas High Performance Assembly Lube will eliminate dry starts and prevent seizing galling and scuffing



LOP-10153 Assembly Lube 8oz \$ 7.99

Same Day Shipping!

800/576-7661

Front Offset Drive

Alum drive allows one to drive the fuel pump and magneto off the gear drive. Clamps to your fuel pump extension. Gear driven - no belt to replace!



E-4116.M

\$ 579



Billet Offset Drives

Accepts Mallory or MSD Mags. Belt Driven. Includes Bronze Gear. Available in **Fixed Flange** or **Adjustable Clamp** Styles.

- A. **RCD-302000-0005** Front **\$ 898**
- B. **I-2062** Front Drive **\$ 995**
- C. **T-1016** MSD Support **\$ 159**
- D. **I-2030** Chevy Offset **\$ 695**
- E. **I-2040** KB, TFX, BAE **\$ 795**
- F. **I-2037** Cross Coupler **\$ 33**



Front Pump/
Magneto Drive
(Sitko)



Front Pump/
Magneto Drive
(RCD)

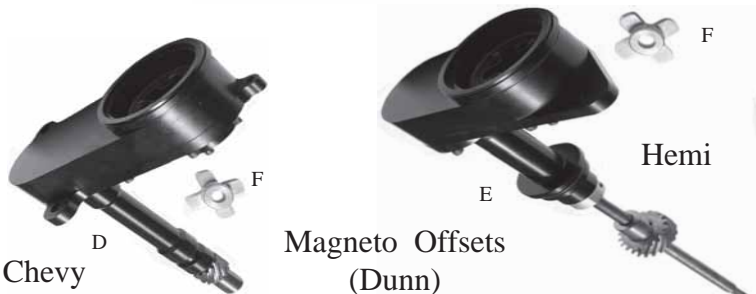

Chevy Magneto Offsets
(Dunn)

Move your Distributor or Magneto to the front.

Clamps to Pump Extension. Uses Std height BBC Base. Postions magneto behind blower belt. Includes Support Bracket.



\$ 709



RCD-302500-0010



Need Spark?

Super Mag III
3.8 amps

Great for supercharged alcohol engines. **Include:** Generator Assembly, Billet Aluminum Base, Pro Coil, QD Wiring Harness, Instructions and Case.

- M-35-36544 LH Hemi Pro Cap
- M-35-59544 RH Chevy Pro Cap
- M-35-59514 RH Chevy Stack Cap

Also Available for Fords & Mopar

\$ 1249

Includes padded shipping case!

Billet Magneto Bases



- A. **M-35595** Chevy Base w/ Bronze Gear **\$ 239**
- M-35365** Hemi Straight Base **\$ 245**
- B. **RCD-303000-0015** Hemi Angled Base **\$ 928**
- C. **I-2042** Hemi Hold-Down Clamp **\$ 65**
- D. **M-45520** Alum Slip Collar Clamp Hemi **\$ 29**
- E. **I-2038** Magneto Clamp Billet Alum **\$ 98**
- F. **M-26041A** SS Steel Magneto Clamp **\$ 69**
- G. **I-2070** Chevy .491 **I-2070** .500 Bronze Gear **\$ 49**
- I E-7025** Hemi Straight Base w/ oil shaft **\$ 356**

Front Drive

Same as unit to the left though does NOT require a magneto base. Works with Mallory or MSD magnetos. Specify CW or CCW.

\$779



RCD-302500-0020





Magneto Components



- M-28103A** Advance Lock Out \$ **34.99**
- M-28995** Rotor (RH) Stack Cap \$ **41.99**
- M-28995A** Rotor (LH) Stack Cap \$ **42.99**
- M-29038** Rotor Adapter \$ **8.99**
- M-29772** Rotor (RH) Pro Cap \$ **22.99**
- M-29772C** Rotor/Adapter w/ nylon screws \$ **64.99**
- M-29773** Rotor (LH) Pro Cap \$ **24.99**
- M-25758M** Premium Contact Points \$ **24.99**
- M-28005A** .36mf (Small) Condenser \$ **32.99**
- M-28005** .56mf (Large) Condenser \$ **39.99**



- M-28862** Wiring Harness \$ **21.99**
- M-205M** HEI Stack Cap \$ **63.99**
- M-29745** HEI Pro Cap \$ **54.99**
- M-29744** Wire Retainer \$ **29.99**
- M-26007B** 4 Pin Drive Flange \$ **38.99**
- M-26030** Woodruff Key \$ **1.95**
- M-28797** Shrink Sleeving..... \$ **6.99**
- M-28974** Timing Indicator \$ **3.98**

Electronic Distributors

Low profile with flat cap for max clearance
CNC billet housing / Unilite Pointless
Small Diameter Bowl



- Curved for Blown Engines**
- M-3755801** Ford 351W \$ **419**
- M-3756001** Ford 460
- M-3768501** Chevy V8

Electronic Ford Offset

Billet Alum * Pro Cap * Belt Driven
Ideal for Blown Engines



- Ford 302 / Ford 460 \$ **945**



PRO Plug Wire

Mallory PRO WIRE Plug Wires are designed to withstand the high temperatures that performance engines produce. PRO WIRE Spark Plug Wire provides protection to over 500 degrees F.

Stainless Steel Core



- M-787** Hemi SS Straight Ends \$ **138**
- M-783M** Chevy SS 90 Deg Ends .. \$ **69**
- M-784M** Bulk SS Wire (foot) \$ **1.95**
- M-836** Red Pro Sleeving 25' \$ **89**

SUPER-MAG Transformer

COIL is externally mounted making for a more efficient and powerful magneto. HEI style contact terminals resulting in a more positive wire retention.



- M-28900A** Pro Oil-Filled Coil \$ **234**
- M-28900B** Epoxy-Filled Coil \$ **285**

Oil Pump Drives

Required when running a front drive

- M-29003** Std Chevy Deck Pump Drive \$ **82**
- M-29007** Tall BBC Deck Pump Drive \$ **119**

Magneto Timing Buzzer

Necessary To Set Magneto Timing



Lights & Buzzes

- I-2098** \$ **79**
- ZIG-TB100** \$ **119**

Kill Switches

\$ **99**



Premium Super Mag Kill Switch
M-26074 \$29



Designed specifically for Mallory & MSD magnetos. Positive push-off. Internally sealed to prevent corrosion. Single or dual mags.

- I-2096** Mallory **I-2097** MSD 44 (**I-2099** Change Over \$**89**)

Air Actuated Kill Switch

Ideal for Top Fuel & Alky.
Connect to your CO2.



- I-2095** \$ **369**



Power Building DVD's

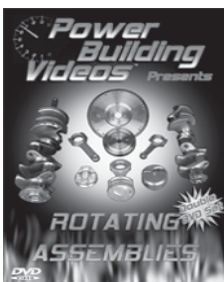
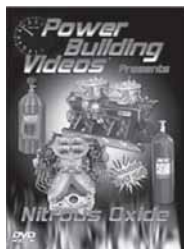

Multi-DVD sets are part of a series tailored towards racing and street performance. Filled with money and time saving advice. Great for the novice and veteran.

- PWR-D-NITROUS Nitrous**
- PWR-D-SUPR Blowers**
- PWR-D-CARB Carburetors**
- PWR-D-ROT Rotating Assy**

\$29.95

Good Vibrations will refund the price of the Blower DVD with the purchase of a blower!

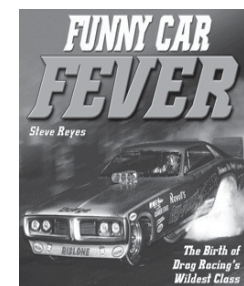
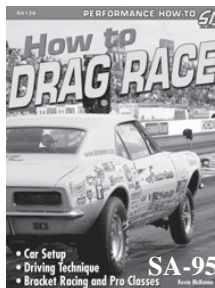
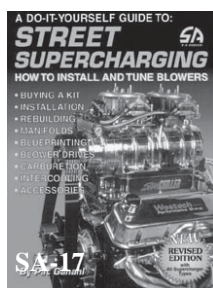

2 Great Books for the Coffee Table, Office or where ever you do your best reading! Rich in History with 100's of Color Pics.

- FC Fever** **Slingshots**
- SA-CT443** **SA-CT464**



\$25

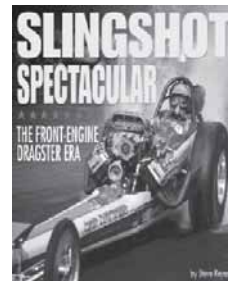

Performance Books

Books are 128 pages. Feature 300 photos!

- SA-78 BUILD PERF PONTIAC**
- SA-85 BUILD BIG INCH SBF**
- SA-87 BUILD BIG INCH SBC**
- SA-104 BIG INCH SB Mopar**

Above Titles **\$16.95**

- SA-17 Street Supercharging \$19.95**
- SA-104 Big Inch SB Mopar \$19.95**
- SA-161 Electronic Fuel Injection \$25**
- SA-95 How To DRAG RACE \$25**

Legal Stuff... Telephone Orders

Order lines are open between 8am and 4:30pm (PST) Mon-Fri. Also online at: www.DragParts.com. Most orders are processed and shipped within 24 hours. UPS is the method of shipping unless otherwise specified. Domestic UPS Ground is approximately 1-4 business days, depending on your location. Faster service is available (See Pg 51).

Payment Policy

Orders can be prepaid by Mastercard, Visa, Discover credit/debit cards. Cancelled orders can be subject up to a 15% cancellation fee.

Freight & Shipping

All shipments are shipped freight prepaid unless other arrangements are made. All shipments are fully insured. If your shipment is damaged, save all packaging material and contact the freight carrier immediately.

Returns

A copy of the original invoice must accompany all returns within 30 days of the original purchase date. No reasonable return will be refused, however we reserve the right to apply up to a 15% restocking fee.

Shortages or Discrepancies

All shortages or discrepancies must be reported within 10 days from receipt of shipment. Please include invoice number and date of receipt.

Warranty

Most products carry the manufactures warranty. Good Vibrations Motorsports will not be held liable for any loss, damage, injury or casualty arising from the use of products supplied by Good Vibrations.

Prices & Specifications

All prices are subject to state sales taxes where applicable. All prices are subject to change without notice.

Not for sale or use on pollution controlled vehicles

Limited Edition T-Shirt

\$12

Good Vibrations (Rear)

Enderle (Front)

Silkscreened 6 Colors

100% Pre-shrunk

USA Cotton

S-3XL



Hats & Shop Aprons

High Quality Embroidery. Velcro Closure. Full Color.



Hats \$12

Aprons \$18





Mission Statement

At Good Vibrations Motorsports we strive to provide high quality performance products at discount prices without sacrificing customer service.

Why Buy From Good Vibrations?

* Prices

Never pay Retail. All products are generously discounted.

* Quality

We sell premium quality products only.

* Technical Support

No Question is too tough.

Deal directly with enthusiasts that speak your language.

* Promptness

97% of orders are shipped the same day.

Sales & Tech Crew

“We’re here to serve you!”



Jim Maher



Jessica Lascano



Randy Walton



Maribel Menchaca

How to Contact Us

Orders... **800/576-7661**

Tech/BS **562/945-7669**

Fax..... **562/693-9553**

E-mail.... **sales@DragParts.com**

Web..... **www.GoodVibrationsRacing.com**

Mail: 8858 Painter Ave, Ste. E, Whittier, CA 90602



GUARANTEED Ground Shipping Time -Or your money back!

Outbound View

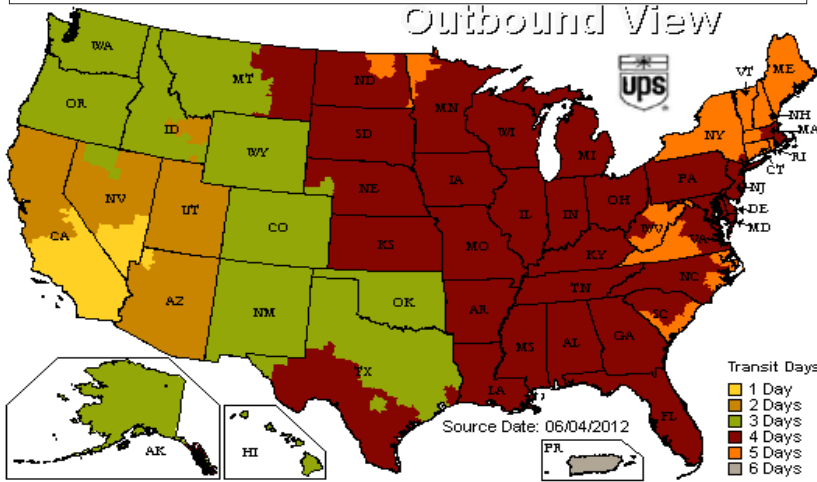

Kasey Smith



James



Shawna Snyder

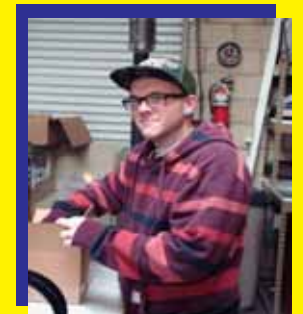

Russ Conlin

We also Ship International Daily!!

Our Mission:

At Dragparts.com, we strive to provide high quality performance products at discount prices without sacrificing customer service.



Good Vibrations

8858 Painter Ave, Suite E
Whittier, CA 90602

PRSRST STD
US Postage
PAID
Whittier, CA
Permit #243

- New Racing Products
- Used Performance Parts
- Free Technical Advice
- Online How-To-Videos
- Free Racing Classifieds

From mild street rods to blown alky racing, we speak your language!



*Proudly Made
in the USA
Since 1985*



Online 24/7

GoodVibrationsRacing.com

New & Preowned Performance Products

Toll Free (800) 576-7661

We Ship International Daily !