

2010-2011

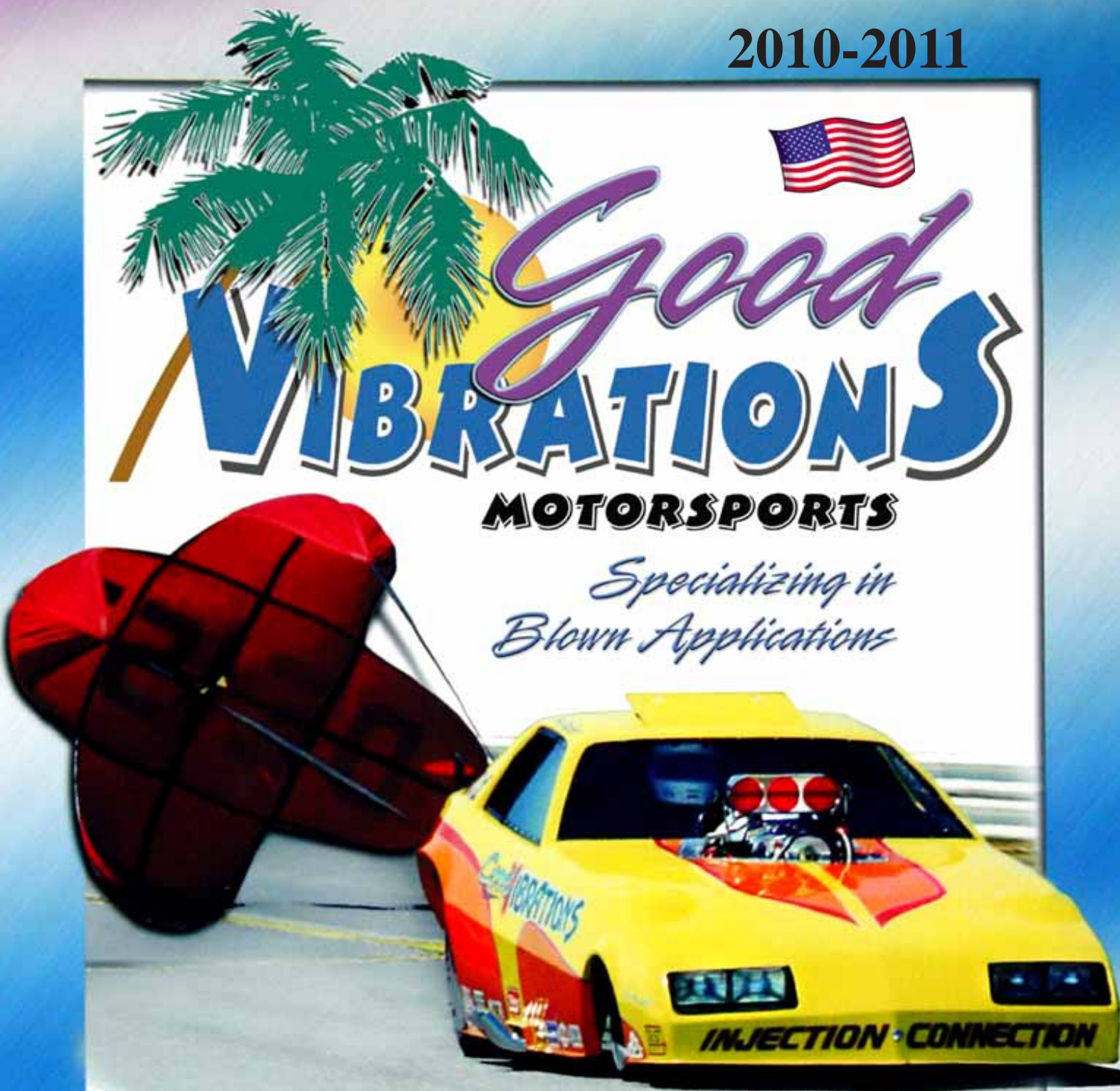

Performance Products

800-576-7661

Open 24/7: www.dragparts.com



Mission Statement

At Good Vibrations Motorsports we strive to provide high quality performance products at discount prices without sacrificing customer service.



Jim Maher

Why Buy From Good Vibrations?

* Prices

Never pay Retail. All products are generously discounted.

* Quality

We sell premium quality products only.

* Technical Support

No Question is too tough.

Deal directly with enthusiasts that speak your language.

* Promptness

Most orders are shipped the same day. Calls are returned ASAP.

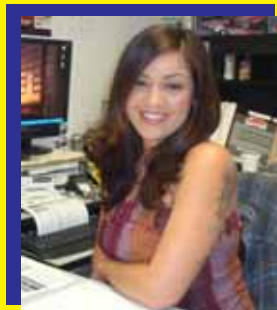

Jessica Lascano



Randy Walton

How to Contact Us

Orders... **800/576-7661**

Tech/BS **562/945-7669**

Fax..... **562/693-9553**

E-mail... **sales@DragParts.com**

Web..... **www.DragParts.com**



Maribel Menchaca



Kasey Smith

Mail: 8858 Painter Ave, Ste. E, Whittier, CA 90602

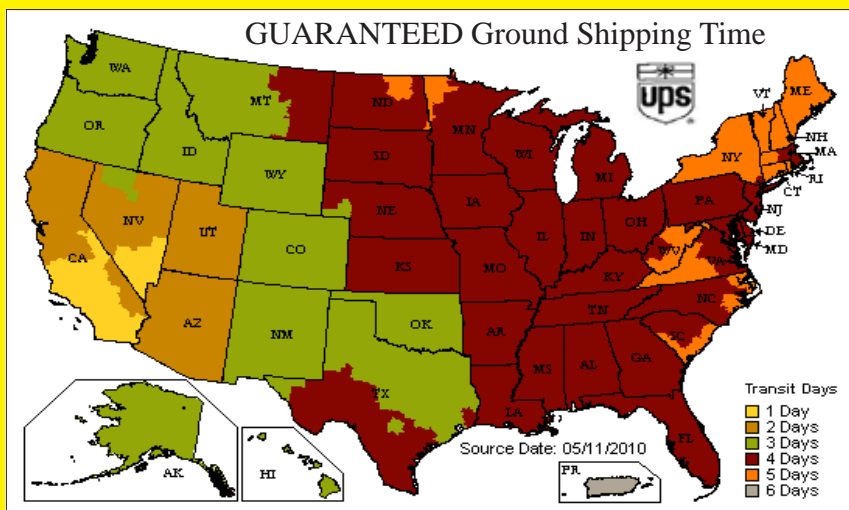

Steve Jachimski



"James"



Eric Ortiz



"Jessica"

We Ship International !!

Blower Injectors



All blower injectors are complete with: Barrel Valve, Fuel Lines, Nozzles & Bodies, Check Valve, Distribution Block & Bypass Pills.

Injectors are set up per customer application FREE at NO additional charge.

Blown	E-1002 Bugcatcher	\$ 1098
Alky	E-1004 Birdcatcher	\$ 1248

Blown	E-1001 Bugcatcher	\$ 1148
Gas	E-1003 Birdcatcher	\$ 1328

Injector Hat - Partial

Includes:

Polished Hat, Shaft, Stops, Double Arms and Butterflies.



E-4005 Bug **\$ 499** E-4006 Bird **\$ 669**

3-Rib Nostalgia Bugcatcher



It's Back! This injector is nearly identical to the original Bugcatcher of days gone by. Has the three ribs on the top rear. Ideal for that nostalgia look.



E-4005F Finned Bugcatcher **\$ 559**

Big & Ugly Injector

Your Choice: TALL or SHORT

This new tall aluminum injector hat is Enderle's replica of the carbon fiber hats. It has a highly luster polished finish and billet front. Available complete or partial w/ Shaft, Butterflies, Stops & Arms.

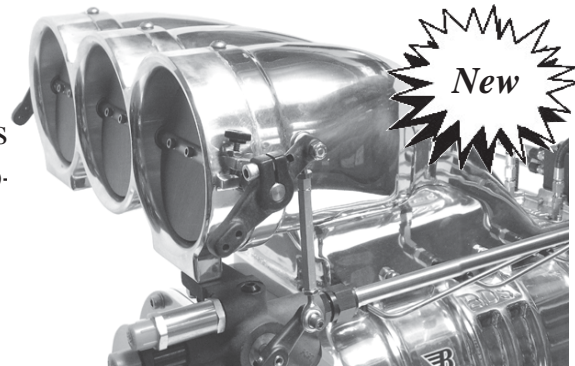

Weight ... 16lbs
Tall ... 10.7"
Short 8.3"

4 Butterfly Sizes: 3 9/16, 4 3/8, 5 and 5 9/16

E-BAU-1 5 9/16 Injector. Complete **\$ 1978**

E-BAU-1-SB 5 9/16 Injector. Partial **\$ 1298**

E-BAU-3 4 3/8 Injector. Complete **\$ 1748**

E-BAU-3-SB 4 3/8 Injector. Partial **\$ 1098**

Barrel Valve Leakdown

- * Block off all injector lines & returns except for hat nozzles
- * Connect dual gauge tester to outlet of compressor
- * Set Air Compressor to read 100psi on 1st gauge
- * Connect tester to inlet of barrel valve
- * Read % on 2nd gauge
- * Adjust Linkage Turnbuckle for % (Lengthen to Richen, Shorten to Lean)

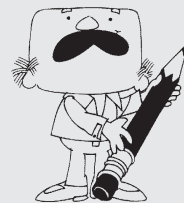

Leakdown Tester

Dual Gauge w/ 14mm Cylinder Hose Professional Grade

TS-14MMLDT

\$ 105



GV-08026 Injector Hose AN6 **\$19**

Why Enderle Mechanical Fuel Injection ??

- * *Consistent & Responsive*
- * *Dependable & Affordable*
- * *FREE Tech Support*
- * *Looks Cool !*

E-2100A Bugcatcher	\$ 1198
E-2101A Birdcatcher	\$ 1348
E-7075 Edelbrock BBC TR Base ...	\$ 369
E-7070 Edelbrock SBC TR Base ...	\$ 329
E-460BT Blue Thunder BBF Base ..	\$ 569
E-TRA7075 BBC Top Plate	\$ 148
E-SBTRA SBC Top Plate	\$ 148

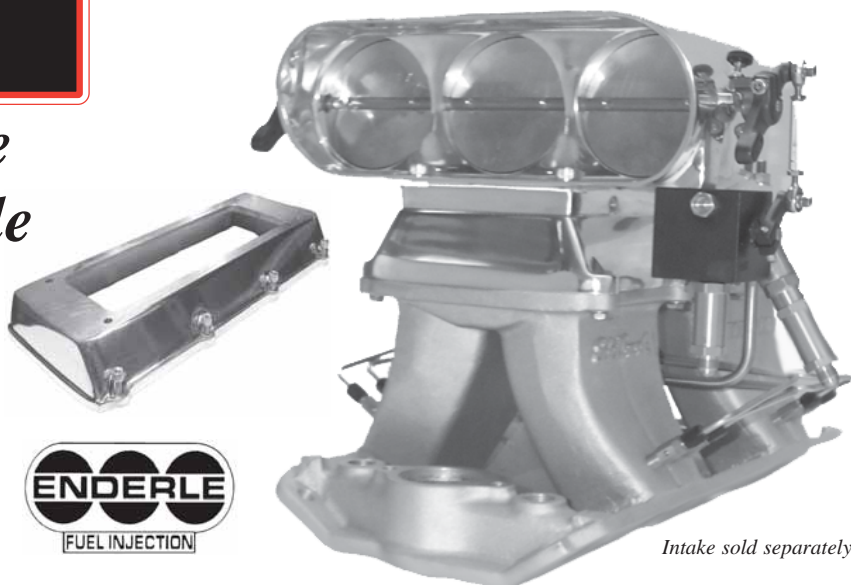

Intake sold separately



*Injectors are set up per customer application
FREE at NO additional charge.*

All Tunnel Ram Injectors are complete with:

Barrel Valve, Fuel Lines, Nozzles & Bodies, Main and Secondary Check Valves, Dist Block & Bypass Pills.

Convert Your 4 Barrel Manifold into Fuel Injection!

Single/Dual Butterfly Injector

Injectors complete with: Barrel Valve, Lines, Nozzles, Pills and Air Filter Bracket. Has standard Holley four barrel bolt pattern. **Gas or Alky.**

Single Body

E-2020.39 4" Assy	\$948
E-2020.50 5" Assy	\$978

Dual Body

E-2030.39 4" Assy	\$1298
E-2030.50 5" Assy	\$1348

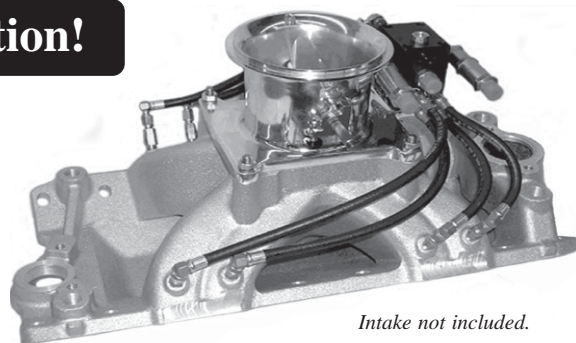

Intake not included.



Premium Fuel Filters

System One filters are made from billet alum and feature a reusable 30 micron SS filter. Handles high pressure without volume loss.

Pro-Street 2 x 4" \$89

SYS-200-201406 AN6
SYS-200-201408 AN8
SYS-200-201410 AN10



Gas, Alky & Nitro



Race 2 x 6" \$113

SYS-201-203406 AN6
SYS-201-203408 AN8
SYS-201-203410 AN10
SYS-201-203412 AN12

Race - Long 2 x 9" \$135

SYS-202-202406 AN6
SYS-202-202408 AN8
SYS-202-202410 AN10
SYS-202-202412 AN12

JAZ inline billet aluminum filters are 5in long and feature a 35 micron element.

JAZ-836-001-11 3/8" Barb	<div style="border: 1px solid black; padding: 5px; display: inline-block;"> Gas Only </div>		<div style="border: 1px solid black; border-radius: 50%; padding: 10px; display: inline-block;"> \$39 </div>
JAZ-836-006-11 AN6			
JAZ-836-008-11 AN8			
JAZ-836-010-11 AN10			

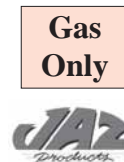

\$58

E-4056

Aluminum fuel filter designed to mount before the pump. Has two AN12 female ports and a reusable stainless steel screen.

AN12 Mounts
Inline



\$28

X-980012FS

SS Pump Loop Lines **Most \$23**

Pre-bent stainless steel loop lines are designed to return fuel to inlet of pump.

- E-110HS6 110 High Speed
- E-110SO6 110 Shut Off
- E-110SOT6 110 Shut Off using a tee (shown)
- E-80AHS6 80A High Speed
- E-80ASO6 80A Shut Off
- E-80ASOT6 80A Shut Off using a tee
- E-Loop-AN6 AN6 K-style B/V (shown)

Complete Loop Kits: **\$65 to \$79**

Line Only
(Call for Kits)



Pump Belt Drive **\$259**

Belt drive kits allow one to drive the fuel pump off the crankshaft. Required if your water pump blocks access to the cam.

- E-5011 SBC
- E-5010 BBC
- E-5012 SBF
- E-5014 BB Mopar
- E-5014A Blown
- E-5015 BBF



Pump Inlet Fitting with Returns

Return fuel lines to the inlet of pump. Available for most fuel pumps.



\$33

Flowed Fuel Pumps



All Pumps are Coated Inside

- E-3002 80A-0 (4 gpm) **\$ 449**
- E-3003 80A-1 (7.1 gpm) **\$ 449**
- E-3003.DSR 80A-1 (7.5) **\$ 499**
- E-3004A 600 (9.2 gpm) **\$ 499**
- E-3004 110 (13.2 gpm) **\$ 499**
- E-3005 990 (15.5 gpm) **\$ 599**
- E-3006 1100 (17.2 gpm) **\$ 649**
- E-3008 1270 (20.2 gpm) **\$ 699**
- Lil Bertha (20.0 gpm) **\$1489**
- E-2000C 3-Hole Collar **\$ 39**

Fuel Pump Exts



- * 3pc Billet Aluminum
- * 360 Degrees Adjustable
- * Internal Shaft & Bearing

Lengths: 2 - 6 inches (1/2" Inc.)

Standard Ext From **\$ 115**

Quick Release From **\$ 141**

QR SS Clamp **\$ 45**



3-Way Fuel Shutoff Valve

Adjustable 360 Degrees
Includes Arm & Fittings

Mandatory on Enderle pumps

- E-85110 AN6 S/O Valve **\$ 84**
- E-85210 AN8 S/O Valve **\$ 109**
- E-110BR Cable Bracket Kit ... **\$ 29**
- E-85103 O-Ring/Seal Kit AN6 **\$ 12**
- E-85203 O-Ring/Seal Kit AN8 **\$ 12**

Port Line Kit **\$ 359**

Complete w/ Nozzles and Bodies, SS Lines, Dist Block, AN8 Check Valve.



Available with Rubber Hoses .. **\$ 329**

Barrel Valves



Enderle Barrel Valves can be used on Gas, Alky or Nitro.

Available for Blowers & Tunnel Rams.

- E-MVORM O-Ring Kit (Specify Style) **\$ 10**
- E-4018 Gas Metering Piston **\$ 67**
- E-4018-32 Tunnel Ram Metering Piston ... **\$ 67**
- E-4019 Alcohol Metering Piston **\$ 67**
- E-4020A Alky Metering Piston K-Style **\$ 82**
- E-4023 Square-Style Barrel Valve Assy **\$ 239**
- E-4024A K-Style Barrel Valve Assy **\$ 259**



Pills, Nozzle Jets, Holders

Enderle **Bypass Pills** are the Screw-In style and are designed to divert fuel away from the engine. The larger the pill, the leaner the mixture.

Sizes:
.020 to .209
E-7009 Bypass Pill **\$2.95**



Hi-Speed kit .050-.095 **\$28.99**



New
Install pills without damaging. Stores 8 pills.
E-7009.SD Driver **\$35.95**



Alum storage holder is a convenient place to store up to 40 bypass pills.
E-7010 Pill Holder **\$19.99**

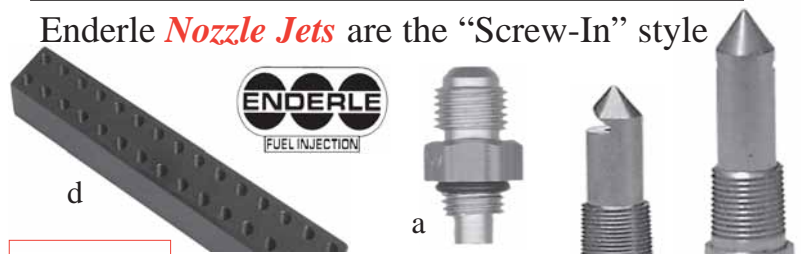

Anodized aluminum storage holder is a convenient and safe place to store up to 60 jets.

- Sizes:** .016 to .99
- a. E-7007 Brass Nozzle Jet **\$ 4.35**
 - a. E-7007A Flowed Nozzle Jet **\$ 6.85**
 - b. E-7121A Port Nozzle Body **\$ 8.99**
 - b. E-7130A Ball Check Port Body **\$ 15.99**
 - c. E-7110A Top Nozzle Body **\$ 8.99**
 - d. E-7011 Jet Storage Holder **\$ 19.99**



Hydrometer Kits

Hydrometer kits come complete with hydrometer, glass beaker and protective wooden carrying case.

Available: Gas, Alcohol and Nitro.

Nitro Sizes: 0-50% & 50-100%



- E-7012 Hydrometer Kit Gas/Alky .. **\$ 159**
- E-7013 Hydrometer Kit Nitro **\$ 159**
- E-7014 Hydrometer only **\$ 58**
- E-7015 Beaker only **\$ 36**

Injector Hat Spacer



Spacers 13.25" C-C
Choice: 2 or 3" tall
Includes Studs and Nuts.
Adapter allows one to bolt a smaller hat (13.25" bolt pattern) to a large blower (15.25").

Polished Alum

- E-BS2 2in Injector Spacer **\$ 87**
- E-BS3 3in Injector Spacer **\$ 90**
- LIT-IS Hat Adapter **\$139**

Injector Hat Filter Assembly

Keeps rocks and debris out of your engine & blower.

A Must for the Sand!

Kit includes:

- Outerware
- Stainless Steel Rods
- Billet aluminum housing
- SS Quick Disconnect Pins
- Reusable K&N filter element



- MPR-10-8656-105C Bugcatcher 10"..... **\$ 395**
- MPR-10-8656-55C Bugcatcher 5"..... **\$ 395**
- MPR-10-8193-105C Birdcatcher 10" ... **\$ 395**
- MPR-10-8193-55C Birdcatcher 5"..... **\$ 395**
- MPR-10-3877-1075C Buzzardcatcher 10" **\$ 449**
- MPR-10-9999 Big & Ugly 10" **\$ 498**
- Outerware:** (Red, Blue, Black, Purple) **\$ 25**



Also available: Replacement Filters & SS Quick Pins

Quality Fuel Injection Components



- E-4013 - 4014 - 4103 Bugcatcher butterfly (black, red, blue, plain) ... \$ 11
- E-4014 Birdcatcher butterfly (black, red, blue, plain) ... \$ 17
- E-4103 Buzzard butterfly (black, red, blue, plain) \$ 23
- E-4103CF Big & Ugly butterfly (black, red, plain) \$ 23
- E-4011 Small serrated arm \$ 8
- E-4011A-5/16 Double serrated arm Bug \$ 16
- E-4011A Double serrated arm Bird/Buzz \$ 16
- E-4011B Long double serrated arm Bird/Buzz \$ 17
- E-4012-5/16 Throttle stop Bug \$ 10
- E-4012 Throttle stop Bird/Buzz \$ 10
- E-4012TS Throttle stop thumb screw \$ 2
- E-4026 Barrel Valve Linkage Turnbuckle Assy \$ 17



- E-5001 SBC Alum Front Cover \$ 104
- E-5002 SBC Front Cover Seal \$ 14
- E-5003 SBF Alum Front Cover \$ 104
- E-5004 BBC Alum Front Cover \$ 104
- E-5008 Hex Drive Assy Chevy \$ 44
- E-4009 Bugcatcher shaft \$ 77
- E-4010 Birdcatcher shaft \$ 95
- E-4102 Buzzardcatcher shaft \$ 106
- GV-HATSTUDS Hat Injector Stud Kit 4pc \$ 11
- E-4031 Stainless Steel Hat Line Set \$ 107
- E-4034 Rubber Hose Hat Line Set. \$ 107
- Barrel Valve O-Ring Kit \$ 10

Hi-Speed Assembly

Bleeds off fuel at higher rpm. Frees up top-end horsepower. Installs between pump and distribution block.



\$66

E-7019 HS Unblown E-7018 HS Blown

Distribution Blocks

Distribution Blocks feature a black billet alum housing and includes fittings. Also machined for use with a primer check valve.



- E-4027 Hat Dist Block w/ 8 fittings \$ 59
- E-4027A Hat Dist Block w/ 12 fittings \$ 69
- E-4027VW Port Dist Block w/ 4 fittings \$ 32
- E-4028 Port Dist Block w/ 8 fittings \$ 58

Fuel Log & Y-Blocks

Fuel Log routes three AN6 returns into one outlet. Mounts to the side of Shutoff Valve. Accepts three "Screw-In" bypass pills.

Billet Alum and HA. Two AN8 inlets, One AN12 outlet



- E-4131 Y-Block .. \$61
- GS-FuelLog .. \$95

Billet Alum Y-Blocks have Dual Inlets and a Single Outlet.
3 Sizes: 8-6, 10-8 or 12-10

\$59



Check Valves

Brass check valves feature a one-way, spring-loaded poppet design. PSI is varied by springs and shims.

- AN6 Check Valves \$ 35
- AN8 Check Valves \$ 48
- Primer Check Valve AN4 \$ 20
- AN6 Spring & Shim Kit \$ 19



On-Board Primer System

Prime mechanical fuel injection from inside the driver's cockpit. Includes 1/2 qt Stainless-Steel tank.

\$99

Kit Includes

- SS Fuel Cell 1/2 qt
- Primer Check Valve
- 5' Braided SS Hose
- Hose Fittings

* Electric Pump Required





Injected? Get Connected!



\$ 98

Throttle Cable Bracket

6061 Billet aluminum swingover hookclamp. Provision for springs. Fits most blower & tunnel ram injectors. TF/TA Approved.

GS-BAUBRACKET

Throttle Stop

Quick Release in < 1 Second
Billet Aluminum w/ SS Pin
Top Fuel/ TA Legal

GS-THRTSTOP

\$ 59

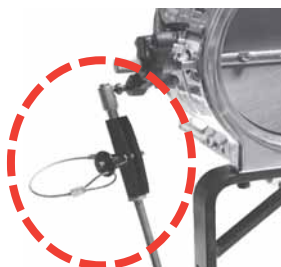

Return Springs



Special bend prevents spring from detaching from injector. Includes Grade 8 10-24 bolt & locking nut.

GS-BAUSPRING.P Primary (Strong)

GS-BAUSPRING.S Secondary (Medium)

\$7.95

Injector Hat Linkage Kit

\$ 89



Designed to work with mechanical fuel injection (Bug or Birdcatcher) on blown applications only. Adjustable heim end design and needle bearings for smooth throttle operation.

E-76-GVIHL

Blower Mounted Throttle Cable Bracket

Works with bug or bird. Anodized aluminum. Mounts to front of blower. Swingover hook clamp. Provision for springs. SAE-239B

\$ 35



Carb Linkage Kits

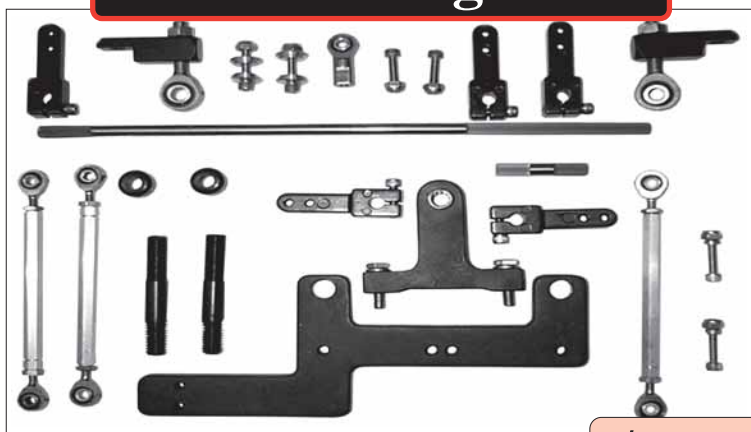

Blower Linkage Kits

\$ 119

For dual Holley double pumpers, Dominators & Predators mounted **Side-Saddle**. Includes adjustable heim end design and needle bearings for smooth throttle operation. E-76-107

For Holley vacuum secondary, Dominators, Predators & Carters mounted **Inline** on a 8 9/16 center-to-center distance. Includes adjustable heim end design and needle bearings for smooth throttle operation. E-55-501

Tunnel Ram Linkage Kits

Everything needed for mounting **Dual Carbs** on a Tunnel Ram **Side-Saddle**

\$ 119

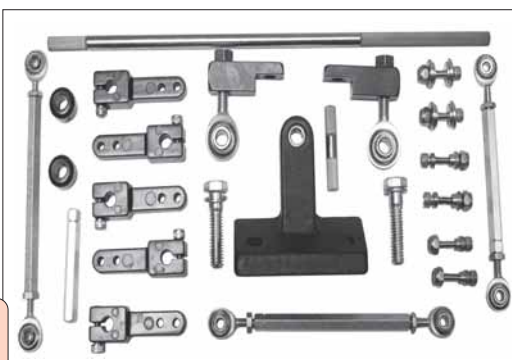

E-72-2000 SBC

E-71-1000 BBC

E-75-107 Ford 351C

E-75-220 Ford 460

Progressive .. \$ 48

Dual Carbs Inline on a TR

E-67-260SB **SB Chevy**

E-67-260FBB **BB Chevy**

Fabricated Valve Covers

Valve covers are fabricated from 6061 alum and welded with billet rails. Designed for the racers who demand a higher quality valve cover with extra room for valve train.

Includes all hardware



BBC



SBC



SBF

- RPC-S6144 SB Chevy **\$ 139**
- RPC-S6244 BB Chevy **\$ 179**
- RPC-S6344 SB Ford **\$ 149**
- RPC-S6247 BB Mopar 440 **\$ 179**

426 Hemi

Show Polished Aluminum
Use Stock Tubes
Original Design
Machined for Breathers

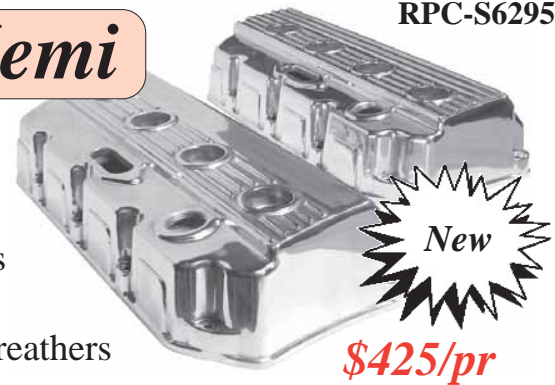

\$425/pr

Premium Gaskets

Steel Core * Teflon Coated
Popular with Top Alky & Top Fuel Teams



- SCE-266075 Hemi **\$35**
- w/o Steel Core **\$22**



SB Ford



BB Chevy

Pontiac



SB Chevy

Aluminum Valve Covers

- * Tall for Clearance
- * Quality Casting
- * Recessed & Baffled
- * Hole for Breather

- RPC-S6152 SB Chevy 283-350 **\$ 79**
- RPC-S6230-1 BB Chevy 396-502 **\$109**
- RPC-S6172 289-351W 5.0L Ford **\$ 85**
- RPC-S6133 326-455 Pontiac **\$ 89**
- RPC-S1006 Wing Nut 1/4 -20 x 4in **\$ 3**

Dress Up Kits

Consist of chrome steel valve covers (baffled), breather cap and rubber grommets. Several kits contain chrome timing chain cover, dipstick with tube, wing nuts and timing tab.

- RPC-S3023 SBC Kit - Short **\$ 44.95**
- RPC-S3024 SBC Kit - Tall **\$ 44.95**
- RPC-S3025 Ford 289-351W **\$ 49.95**
- RPC-S3026 BBC Kit - Tall **\$ 54.95**
- RPC-S3027 BBC Kit - Short **\$ 54.95**
- RPC-S3029 SB Mopar Kit **\$ 49.95**
- RPC-S3030 Pontiac Kit **\$ 49.95**



SB Chevy



BB Chevy



SB Ford



Pontiac



SB Mopar

Valve Cover Gaskets

High performance black rubber with solid steel core.



Pair

- S7484 SBC **\$ 12.95**
- S7485 BBC **\$ 14.95**
- S7486 SBF **\$ 12.95**
- S7493 BBF **\$ 14.95**
- S7494 Mopar .. **\$ 12.95**
- S7490 Olds **\$ 14.95**
- S7482X Pont .. **\$ 14.95**

More Quality Gaskets?
See Pg 36

Show Quality Blowers



BDS blowers are hand assembled with competition components.

Special features include: Double lipped teflon seals, heavy-duty bearings, double pinned rotors, sight gauges. **Options:** Billet bearing plates, hard anodizing, teflon strips and front discharge cases.



Many blower companies use reconditioned GM diesel rotors in their blowers. **Air-Loc** are BDS brand NEW cast rotors. Makes more boost at cooler temperature. **Bottom line:** More Horsepower. BDS **Pro-Loc** are **billet** rotors; available in standard or hi-helix.

Polished 6.71 -14.71

6.71 Street	\$ 1495
6.71 Race	\$ 2250
6.71 Air-Loc	\$ 3395
8.71 Street	\$ 1995
8.71 Race	\$ 2750
8.71 Air-Loc	\$ 3395
8.71 Pro-Loc	\$ 4345
14.71 Air-Loc	\$ 4195
14.71 Pro-Loc	\$ 4345
14.71 Hi-Helix	\$ 4750

Race style has 18 strips of teflon. Rotors and inside of case are hard anodized.

BDS Blower Kits are some of the finest on the market. Show-Quality & Precision Machined.

Kits Include: Blower, 1 V-Groove Drive Kits, Dual Carb Adapter, Bolts, Gaskets & Warranty!

Kits are Custom Assembled per your Application

- SB Chevy 6.71 Kit **\$ 2990**
- BB Chevy 8.71 Kit **\$ 3490**
- 426 Hemi 8.71 Kit **\$ 3849**
- 455 Pontiac 8.71 Kit **\$ 3890**

Call for Others

Popular Kit Options:

- Polish Blower **\$205** Upgrade to 8mm **\$65**
- Polish Manifold **\$110** Upgrade to Stage II Blower **\$239**

Street/Strip Blower Kits

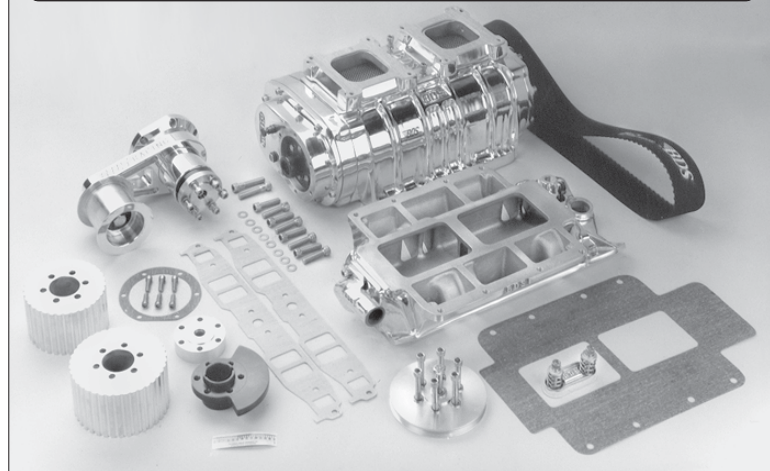

BDS Blower Drive Kits are manufactured from aircraft **Billet** aluminum and steel alloys to ensure maximum performance and durability. Drive Kits are highly polished and are custom designed for **your** application.

Includes: Drive Snout, Gear Coupler, 2 Pulleys, Idler Pulley & Mounting Hardware, Blower Belt, Steel Crank Hub, All Gaskets, V-Groove Pulley, Bolts, Spacers and Instructions.

Priced from ... **\$1195**

Blower Drive Kits





8mm



Drive Ratio Chart

BOTTOM PULLEY

TOP PULLEY

	43	44	45	46	47	48	49	50	51	52	53	54	55	56
47	9.3	6.8	4.4	2.2	1.0	-2.1	-4.1	-6.0	-7.2	-9.6	-11.3	-13.0	-14.5	-16.1
48	11.6	9.1	6.7	4.3	2.1	1.0	2.0	-4.0	-5.9	-7.7	-9.4	-11.1	-12.7	-14.3
49	14.0	11.4	8.9	6.5	4.3	2.1	1.0	-2.0	-3.9	-5.8	-7.5	-9.3	-10.9	-12.5
50	16.3	13.6	11.1	8.7	6.4	4.2	2.0	1.0	-2.0	-3.8	-5.7	-7.4	-9.4	-10.7
51	18.6	15.9	13.3	10.9	8.5	6.3	4.1	2.0	1.0	-1.9	-3.8	-5.6	-7.3	-8.9
52	20.9	18.2	15.6	13.0	10.6	8.3	6.1	4.0	2.0	1.0	-1.9	-3.7	-5.5	-7.1
53	23.2	20.5	17.8	15.2	12.8	10.4	8.2	6.0	3.9	1.9	1.0	-1.9	-3.6	-5.4
54	25.5	22.7	20.0	17.4	14.9	12.5	10.2	8.0	5.9	3.8	1.9	1.0	-1.8	-3.6
55	27.9	25.0	22.2	19.6	17.0	14.6	12.2	10.0	7.8	5.8	3.8	1.9	1.0	-1.8
56	30.2	27.3	24.4	21.7	19.1	16.7	14.3	12.0	9.8	7.7	5.7	3.7	1.8	1.0
57	32.5	29.5	26.7	23.9	21.3	18.8	16.3	14.0	11.8	9.6	7.5	5.6	3.6	1.8
58	34.8	31.9	28.9	26.1	23.4	20.8	18.4	16.0	13.7	11.5	9.4	7.4	5.5	3.6
59	37.2	34.1	31.3	28.3	25.5	22.9	20.4	18.0	15.7	13.5	11.3	9.3	7.3	5.4
60	39.5	36.4	33.3	30.4	27.7	25.0	22.4	20.0	17.6	15.4	13.2	11.1	9.1	7.1
61	41.8	38.6	35.6	32.6	29.8	27.1	24.5	22.0	19.6	17.3	15.1	13.0	10.9	8.9
62	44.2	40.9	37.8	34.8	31.9	29.2	26.5	24.0	21.6	19.2	17.0	14.8	12.7	10.7
63	46.5	43.2	40.0	37.0	34.0	31.1	28.6	26.0	23.5	21.2	18.9	16.7	14.5	12.5
64	48.8	45.5	42.2	39.1	36.2	33.3	30.6	28.0	25.5	23.1	20.8	18.5	16.4	14.3
65	51.2	47.7	44.4	41.3	38.3	35.4	32.7	30.0	27.5	25.0	22.6	20.4	18.2	16.1
66	53.5	50.0	46.7	43.5	40.4	37.5	34.7	32.0	29.4	26.9	24.5	22.2	20.0	17.9
67	55.8	52.3	48.9	45.6	42.6	39.6	36.7	34.0	31.4	28.8	26.4	24.1	21.8	19.6
68	58.1	54.5	51.1	47.8	44.7	41.7	38.8	36.0	33.3	30.8	28.3	25.9	23.6	21.4
69	60.5	56.8	53.3	50.0	46.8	43.8	40.8	38.0	35.3	32.7	30.2	27.8	25.5	23.2
70	62.8	59.1	55.6	52.2	48.9	45.8	42.9	40.0	37.3	34.6	32.1	29.6	27.3	25.0

13.9mm/14mm 1/2" Pitch 30-41T

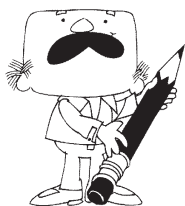

BOTTOM PULLEY

TOP PULLEY

	25	26	27	28	29	30	31	32	33	34	35	36	37
25	1.0	-3.8	-7.4	-10.7	-13.8	-16.7	-19.4	-21.9	-24.2	-26.5	-28.6	-30.6	-32.4
26	4.0	1.0	-3.7	-7.1	-10.3	-13.3	-16.1	-18.7	-21.2	-23.5	-25.7	-27.8	-29.7
27	8.0	3.8	1.0	-3.6	-6.9	-10.0	-12.9	-15.6	-18.2	-20.6	-22.9	-25.0	-27.0
28	12.0	7.7	3.7	1.0	-3.4	-6.7	-9.7	-12.5	-15.2	-17.6	-20.0	-22.2	-24.3
29	16.0	11.5	7.4	3.6	1.0	-3.3	-6.5	-9.4	-12.1	-14.7	-17.1	-19.4	-21.6
30	20.0	15.4	11.1	7.1	3.4	1.0	-3.2	-6.2	-9.1	-11.8	-14.3	-16.7	-18.9
31	24.0	19.2	14.8	10.7	6.9	3.3	1.0	-3.1	-6.1	-8.8	-11.4	-13.9	-16.2
32	28.0	23.1	18.5	14.3	10.3	6.7	3.2	1.0	-3.0	-5.9	-8.6	-11.1	-13.5
33	32.0	26.9	22.2	17.9	13.8	10.0	6.5	3.1	1.0	-2.9	-5.7	-8.3	-10.8
34	36.0	30.8	25.9	21.4	17.2	13.3	9.7	6.3	3.0	1.0	-2.9	-5.6	-8.1
35	40.0	34.6	29.6	25.0	20.7	16.7	12.9	9.4	6.7	2.9	1.0	-2.8	-5.4
36	44.0	38.5	33.3	28.6	24.1	20.0	16.1	12.5	9.1	5.9	2.9	1.0	-2.7
37	48.0	42.3	37.0	32.1	27.6	23.3	19.4	15.6	12.1	8.8	5.7	2.8	1.0
38	52.0	46.2	40.7	35.7	31.0	26.7	22.6	18.8	15.2	11.8	8.6	5.6	2.7
39	56.0	50.0	44.4	39.3	34.5	30.0	25.8	21.9	18.2	14.7	11.4	8.3	5.4
40	60.0	53.8	48.1	42.9	37.9	33.3	29.0	25.0	21.2	17.6	14.3	11.1	8.1
41	64.0	57.7	51.9	46.4	41.4	36.7	32.3	28.1	24.2	20.6	17.1	13.9	10.8
42	68.0	61.5	55.6	50.0	44.8	40.0	35.5	31.3	27.3	23.5	20.0	16.7	13.5
43	72.0	65.4	59.3	53.6	48.3	43.3	38.7	34.4	30.3	26.5	22.9	19.4	16.2
44	76.0	69.2	63.0	57.1	51.7	46.7	41.9	37.5	33.3	29.4	25.7	22.2	18.9
45	80.0	73.1	66.7	60.7	55.2	50.0	45.2	40.6	36.4	32.4	28.6	25.0	21.6

Blower Belts



Race > 35% OD

8mmGT, 13.9 & 14mm

Street/ Race < 35% OD

8mm, 1/2" Pitch

Available in
Rubber or
PolyChain/
Carbon (GT)

1/2 Pitch



540H300	\$ 78
555H300	\$ 89
560H300	\$ 68
570H300	\$ 68
585H300	\$ 74
600H300	\$ 78
630H300	\$ 88
700H300	\$105

2" Wide Available

8mm



1280M75	\$ 148
1360M75	\$ 109
1440M75	\$ 125
1440M75gtc	\$ 159
1512M75gt	\$ 159
1520M75	\$ 149
1600M75	\$ 129
1600M75gtc	\$ 159
1792M75gtc	\$ 218

13.9 & 14mm



1543M65	\$ 145
1543M75	\$ 169
14mm	
1400M75.....	\$ 299
1568M75gtc	\$ 268
1610M75	\$ 248
1694M75	\$ 269
1750M75gtc	\$ 269

Billet Alum Blower Pulleys

3.5" Wide
2.0" Register



1/2 Pitch

OD < 15%
Sizes: 30-41
From \$ 79



8mm

Ratios < 35%
Sizes: 43-70
From \$ 83



8mmGT

Ratios > 35%
Sizes: 43-75
From \$ 96



13.9mm

Ratios > 35%
Sizes: 25-45
From \$ 89



14mm

Ratios > 35%
Sizes: 25-46
From \$ 89

Blower pulleys are machined from billet 6061 aluminum and are T-6 heat treated. Pulleys are 3.5" wide with a 2" register.

Hard anodizing is standard on the 8mmGT, 13.9 and 14mm pulleys. Good Vibrations offers one of the largest selection of blower pulleys.

V-Groove Pulleys

V-Groove Pulleys are machined from billet 6061-T6 alum. Has a 2" register and bolt directly to crank hub with 6 bolts. Can stacked together for PS, AC, Etc...

Adapter-style pulleys bolt directly to harmonic balancers and are available in single or double V-Grooves. Billet aluminum spacers allow one to easily align both top and lower blower pulleys.



BDS-150 Single V-Groove Pulley	\$ 65
BDS-150-12-SB-1 1V-Groove Adap	\$ 85
BDS-150-12-SB-2 2V-Groove Adap	\$109
BDS-150-12-BB-1 1V-Groove Adap	\$ 85
BDS-150-12-BB-2 2V-Groove Adap	\$109

Pulley Spacers



.300 - 1.40" widths
from \$ 19

Accessory Pulleys



Billet Aluminum
Uppers are Polished

Fit Short Water Pumps

RPC-S8840POL BBC Water Pump	\$ 39.95
RPC-S8841 BBC Lower Pulley	\$ 29.95
RPC-S9478POL SBC Water Pump	\$ 39.95
RPC-S9480 SBC Lower Pulley	\$ 29.95
RPC-S9487POL Chevy Alternator	\$ 29.95

Street & Race Blower Manifolds



Chevy Race



440 Mopar



426 Hemi



Chevy Street



392 Hemi



Ford 429-460

Standard Features Include:

- Raised tented floor for improved airflow.
- Solid sides for added strength and rigidity.
- Street include thermostat housing and backfire valve.
- Competition models have port nozzle provisions.
- Most will accept 6.71 through 14.71 blowers.

BDS-8006-1206 SB Chevy Street	\$ 495
BDS-8007-M SB Chevy Race	\$ 448
BDS-8026S BB Chevy Street Std	\$ 548
BDS-8026T BB Chevy Street Tall ...	\$ 578
BDS-8027S BB Chevy Race Std	\$ 448
BDS-8027T BB Chevy Race Tall	\$ 498
BDS-8386-H Mopar 392 Hemi	\$ 478
BDS-8376 Mopar 426 Hemi	\$ 528
BDS-8366 Mopar 440	\$ 448
BDS-8406 Ford 289-302	\$ 998
BDS-8456 Ford 429-460	\$ 698
BDS-8607 Pontiac 326-455	\$ 548

Manifold Components

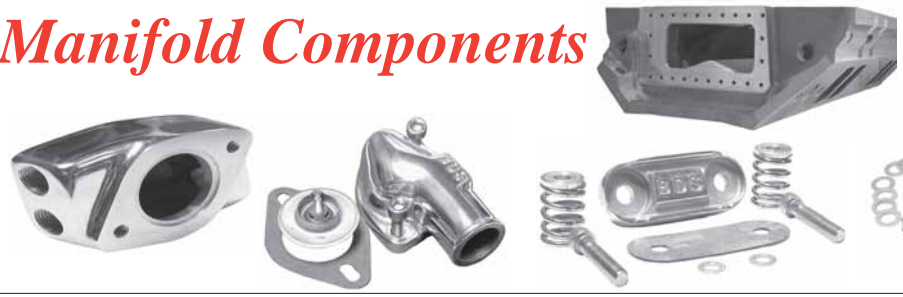

BDS-1400 Remote Thermostat Housing	\$ 59
BDS-1401 Thermostat Housing Kit	\$ 49
BDS-8366AK Large Backfire Valve Kit	\$ 49
Alum Blower Stud Kit	\$ 35
Machine for Burst Panel	\$175

Need Quality Gaskets? See Page 36

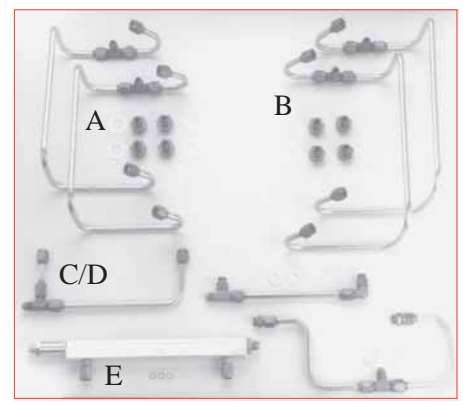

Stainless Steel Carb Plumbing

A. BDS-107-P Standard	\$ 159
B. BDS-107-PD Dominator	\$ 159
C. BDS-107PFL	\$ 48
D. BDS-107PDFL	\$ 48
E. BDS-108 Bar w/check valve	\$ 149

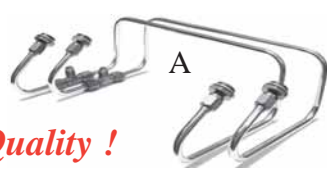

Show Quality!
Polished Seamless Stainless Steel 3/8 tubing with anodized fittings for dual Holley double feed carbs mounted Side-Saddle. Great for Blower or Tunnel Ram systems.

* Also available for Demon Carbs

Blower Components

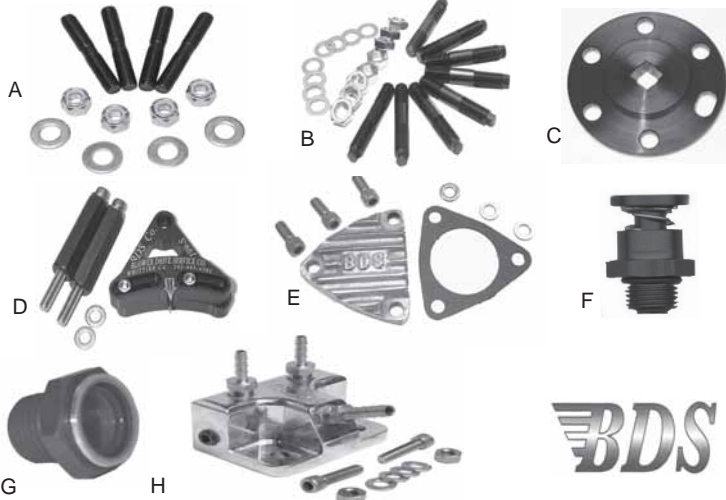

- A **GV-HATSTUDS** Inj Hat Stud Kit (4) \$ 11
- B **GV-BLOWSTUDS** Blower Stud Kit 2.5" (8) .. \$ 35
Longer Blower Studs 3.00" & 3.50" (each) \$ 5
- C **GV-TURNPLATE** Alum Blower Turning Plate \$ 35
- D **BDS-198** Billet Alum Timing Pointer \$ 49
- E **BDS-333K** Billet Tri-Plate Kit \$ 19
- F **BDS-555** Pressure Relief Valve BDS \$ 18
E-PFFT Pressure Relief Valve Black \$ 13
- G **BDS-556** Oil Level Sight Gauge Lexan \$ 18
- H **BDS-1150** Trans Pressure Diversion Valve \$ 69

Blower Snouts

Drive snouts are machined from billet aluminum. Has double ball bearings and HD oil seal. 48-Tooth spline shaft is made from heat treated 4100 steel.

- BDS-500** Street 3.90" \$ 298
- BDS-501** Street 5.75" \$ 338
- BDS-407** Street Coupler \$ 86
- BDS-510** Race 3.90" \$ 348
- BDS-410** Race Coupler \$ 86
- BDS-511** Race 5.25" \$ 378
- BDS-425** Race Coupler \$ 86
- SN0100** Race 6.00" \$ 349
- SN1000** Race 7.00" \$ 349
- SNCOUP** Race Coupler \$ 89

Shaft Size
Street 1.125
Race 1.250



Includes Grade 8 Bolts & Washers

Street snouts are polished

Blower Front Covers



Complete Kit includes: Cover, Pressure Relief Valve, Sight Gauge, Gaskets, Bolts & Washers.

- BDS-671-1C** Cover Only -Satin \$ 115
- BDS-671-1CP** Cover Only -Polished \$ 139
- BDS-671-1C-2** Cover Only -BILLET \$ 189
- BDS-671-1CK** Cover Kit -Satin \$ 149
- BDS-671-1CKP** Cover Kit -Polished \$ 169

Specify: Half or Full Round

Bearing Plates and Covers are available in Polished or Satin finish.
Works on most brands of blowers.

Blower Bearing Plates

Front Plates includes:
Heat-Treated dowels & Bearing Retainers (pr).



Specify: All Square (Detroit style), Half Round or All Round

Rear Plates includes:
Heat-Treated dowels & Bearing Caps (pr).

Cast REAR Billet

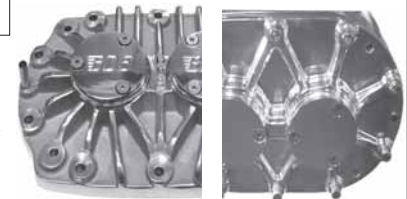

- BDS-671-2C** Front Plate -Satin \$ 109
- BDS-671-2CP** Front Plate -Polished \$ 119
- BDS-671-4** Rear Plate -Satin \$ 129
- BDS-671-4P** Rear Plate -Polished \$ 154
- BDS-671-4-2** Rear Plate -BILLET \$ 183
- BDS-671-5** Rear Bearings Caps Pr. \$ 25
- BDS-671-22** Bearing Retainer Pr. \$ 29
- BDS-671BK** Bearing & Seal Kit 4ea \$ 93

Bearings & Seals also Sold Separate

See Page 36



Chromoly Crank Hubs

Hubs are designed to replace your harmonic balancer. Machined from 4100 steel and broached for 2 keyways.

- BDS-100 SB Chevy Hub \$ 129
 - BDS-109 BB Chevy Int Bal Hub \$ 129
 - BDS-110C BB Chevy Ext Bal Hub \$ 199
 - BDS-136 Hemi 426 Hub \$ 129
 - BDS-139 Hemi 392 Hub \$ 129
 - BDS-125 Ford 429-460 \$ 129
 - BDS-198 Billet Pointer Kit SB or BB \$ 49
 - BDS-199 Alum Degree Ring 7in \$ 69
-
- RCD-202203-05 SBC Hub \$ 139
 - RCD-202603-02 Hemi 426 Hub \$ 139
 - RCD-202803-04 Hemi 392 Hub \$ 159
 - RCD-202403-02 BBC Int Bal Hub \$ 139
 - RCD-202403-09 BBC Ext Bal Hub \$ 268
 - RCD-201010-0010 Degree Ring 6.375 \$ 59
 - RCD-201010-9999 Degree Ring 7.000 \$ 69

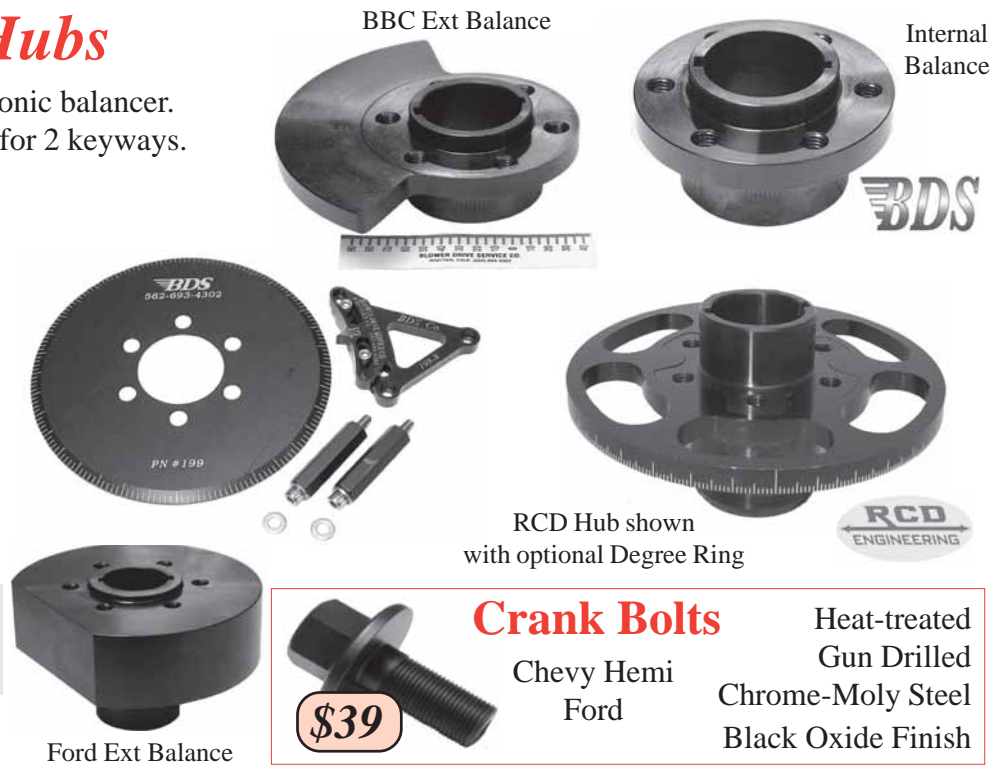

BBC Ext Balance

Internal Balance

BDS

RCD Hub shown with optional Degree Ring

RCD ENGINEERING

Ford Ext Balance

Crank Bolts Heat-treated Gun Drilled Chrome-Moly Steel Black Oxide Finish

Chevy Hemi Ford

\$39

Dampner/Crank Hub Installation Kit



Premium Quality Heavy Duty Case Remove & Installs
RPC-S3940

Burst Panel

Panels are **SFI** Approved. Very popular on TF/TA Engines.

BP Adapter eliminates welding and machining on older intakes.



2pc Alum Frame Kit includes 24 stainless steel bolts. **Tandem Kit** is designed for PSI Blowers and includes 2 panels.

- BM-BP Burst Panel, SFI Approved \$ 25
- BM-BP-3 Burst Panel, **3 pack!** \$ 65
- BURSTCAGE 2pc Frame Kit w/ 24 bolts \$ 65
- GV-BPADAPTER Burst Panel Adapter \$ 75
- BURSTCAGE-TANDEM PSI Blowers \$195

Crank Triggers

Trigger Brackets

- RCD-202010-55 SBC Right \$ 69
- RCD-202010-56 SBC Left \$ 69
- RCD-202010-50 BBC Right \$ 79
- RCD-202010-51 BBC Left \$ 79
- RCD-202010-60 426 Hemi (Pr) \$149
- RCD-202010-63 TFX (Pr) \$149
- RCD-202010-70 392 Right \$ 79
- RCD-202010-71 392 Left \$ 79



Pickup Holders

- RCD-202015-03 MSD Std \$ 49
- RCD-202015-05 Leahy Std \$ 49
- RCD-202015-08 MSD Short Left \$ 39
- RCD-202015-10 MSD Short Right \$ 39
- RCD-202015-12 Leahy Short Left \$ 39
- RCD-202015-14 Leahy Short Right \$ 39



Billet Pointers (For 7' Rings)

- RCD-202022-09 SBC \$ 25
- RCD-202000-0010 KB, BBC \$ 35



Adjustable Pointers for BBC & Hemis. SBC Alum T-Pointer

Degree Ring w/ Magnets

Fits RCD Hubs. 1, 5 & 10 Degree Marks



- RCD-201020-0007 6.375
- RCD-201020-0004 7.000

\$119



Billet Idler Pulleys and Brackets

Machined from Billet 6061-T6 and ShowPolished



Blower Mounted



Billet L-Shape bracket mounts directly to the front of most blowers.

Kit Includes: Bracket, T-Nut, Bolts and Alum Standoffs.

- BDS-600** Bracket \$ 67
- BDS-600KD-1** Kit \$ 149
- BDS-600KD-2** Kit \$ 154

-2 Kits include 1" longer spacer.

Swing Arm



Billet Swing Arm Bracket clamps to snouts (with 3.38" OD). Allows one to adjust the idler pulley for and aft.

- BDS-607** Billet Arm \$ 139
- Idler Bolt 5/8x4"** Bolt \$ 5

Engine Mounted



Competition Style. Mounts to engine block. 3/4" aluminum prevents warpage.

- BDS-605** BBC \$ 109
- BDS-606** SBC \$ 104
- BDS-655-1** Hemi 426 \$ 104
- 156206-09** Hemi 392 \$ 159



Engine Mounted Kits

Includes: Polished Alum Bracket, Water Standoffs (Drilled & Tapped), Mounting Spacers & Bolts, Idler Bolt & Chromoly T-Nut.



- BDS-606K** SBC Kit \$ 239
- BDS-605K** BBC Kit \$ 219



Billet Idler Pulley

Idler Pulleys are machined from 6060-T6 alum and polished. Feature an offset double ball bearing. Crowned center helps keep belt centered. Available in 3.3 or 4.5in Diameter.

Includes: Idler Pulley, Alum Standoff and Washer.



BDS-2002 2" wide ... \$ 139

BDS-3002 3" wide ... \$ 139

4.5" Large Diameter \$ 159

BDS-690 Steel T-Nut \$ 25



Aluminum Idler Pulley Spacers

Spacer Widths .400 to 1.400 From \$10

Alternator Drive Assembly

Designed primarily for BBC applications, features a billet aluminum "V" belt pulley which fits inside the lower blower pulley. Kit is complete with all brackets, stands, belt and fasteners to mount a standard G.M. alternator.



\$ 259

RCD-301000-0010

Blower Belt Guard

Polished Billet Aluminum Stainless Steel Fasteners Bolts Directly to Blower



Available in 5 lengths
6 7.5 8.5 10 & 12"

\$139

Single & Dual Carb Scoops



\$249
Fits Blowers & Most Tunnel Rams

Scoops are replicas of the famous Bugcatcher Injector. Designed to fit single or dual carbs. Highly polished with anodized butterflies. Complete with Mounting Hardware and Filters!

Single Carb		Dual Carb	
RPC-S5238	Ribbed	RPC-S5239	Ribbed
RPC-S5338	Smooth	RPC-S5339	Smooth

Dual Carbs:
7.75 - 9.25 c-c

Hilborn-Style

Hilborn-style scoops are designed for single or dual carbs on Tunnel Rams & Blowers. Polished aluminum with finned or smooth top. Includes: Adjustable mounting hardware, front screen & filter(s).



RPC-S5246 Single Carb \$ 129
RPC-S5233 Dual Carb \$ 149
RPC-S5236 Shotgun-Style .. \$ 249

Blower Only Carb Scoops



Polished aluminum **Dual Carb** scoop for **Standard** four-barrel style carbs *mounted inline* or *side-saddle* on 8 5/8" centers. (Won't fit most Tunnel Rams)

BDS-9000 Dual Carb Blower Scoop \$ 229
BDS-9000C Above w/ Filters \$ 299

Polished **Dual Carb** scoop for **Dominator** style carbs mounted *side-saddle* on 8.75" centers.

BDS-9000D-2 Dual Dom Scoop \$ 369
BDS-9000DC-2 Above w/ Filters..... \$ 519



K&N Air Filter Element, Polished Stainless-Steel Top, Stud & Nut.
BDS-9100K STD Holley \$39 **BDS-9100KD** Dominator \$79
Heavy-Duty Vinyl Scoop Covers embroidered with BDS logo.
Colors: Black, Blue, Purple, Red, Yellow & Pink.
BDS-9001 Vinyl Cover \$25 **BDS-9000D1** Dom Cover \$29

Carb Adapter Plate

Carb Plate Includes: Billet Plate, Screen Gasket, Carb Base Gaskets, Cadmium Plated Bolts & Washers.



BDS-24B6-2 Dual Carb ... \$ 139
Dual four barrel carb adapter plate for a 6.71 or 8.71 blower. Accepts two **Standard** Holley carbs sidesaddle or Carter carbs inline on an 8-5/8" center to center. Holley carbs without secondary metering plates may be run inline.

BDS-24B6D-2 Dual Carb ... \$ 139
Dual Holley **Dominator** carb plate. Accepts two Holley Dominator carbs mounted sidesaddle at 8-3/4" center to center.

BDS-14B6-2 Single Carb ... \$ 129
Single four barrel carb adapter plate for 6.71 or 8.71 blower. Accepts **Standard** Holley and Carter four barrel carbs.



2" Xcelerator is machined from billet aluminum, hard anodized and machined for o-ring. Accepts **carb adapter** plate or **injector**. 3" forward offset for airflow.

BDS-5400-14 \$ 469

Pressure Gauge

Liquid Filled
Boost, Oil, Fuel

\$39

X-710000 0-15psi
X-710030 0-30psi
X-710060 0-60psi
X-710100 0-100psi



Blower Boost Memory Kit .. \$ 39
(Gauge not included in kit)

Pro Street Cells

16 Gallon

With Fuel Level Sender

These 16 gallon cells fit between big wheel tubs or tight frame rails. Features two AN8 pickup fittings and one AN6 vent. Available with or without foam. Fitted with a fuel level sending unit of your choice.



JAZ-253-116-01	18x18x12; 240-33 ohms	\$ 239
JAZ-256-116-01	Same Above No Foam	\$ 195
JAZ-253-016-01	25x17x9; 240-33 ohms	\$ 237
JAZ-256-016-01	Same Above No Foam	\$ 195

Horizontal Race Fuel Cells

Features flush aerospace style cap assembly, two AN8 pickup fittings in the sump and one AN6 vent (or return) on top. Cells are foam filled. Suitable for drag racing, circle track, off-road and street.



JAZ-250-005-01	5 Gallon	\$ 125
JAZ-250-008-01	8 Gallon	\$ 135
JAZ-250-012-01	12 Gallon	\$ 149
JAZ-250-016-01	16 Gallon	\$ 194



Funny Car/Altered Cells



This 12 gallon fuel cell is specially made with one AN12 pickup (Optional AN16). There is one AN6 fitting on top for venting. Fuel injection return lines can be easily installed near the top of this cell.

JAZ-290-112-01 .. \$ 169

Vertical Fuel Cells

Vertical drag race cells come standard with two AN8 pickup fittings in the sump. Each cell is mil-spec foam filled and features a flush aerospace style filler cap.



JAZ-250-001-01	1 Gallon	\$ 125
JAZ-250-003-01	3 Gallon	\$ 125
JAZ-250-004-01	4 Gallon	\$ 132
JAZ-250-105-01	5 Gallon	\$ 132

Steel Mounting Hardware **\$33.95**

Caps & Accessories

Huge selection of premium quality parts for fuel cells.



JAZ Poly Seats

Seats feature one-piece, double walled, seamless construction. Has provisions for 5pt harness. Molded-in threaded inserts included on bottom of seat.

JAZ-100-100-01 \$ 69.97

Seat Covers

Covers are made of heavy duty, leather grained vinyl and are foam padded. Snaps are included for easy installation.

JAZ-150-101-01 \$ 57.97



Aluminum Drag Seat

This seat is designed for serious door slammer applications. It is extremely rigid yet weighs only 9lbs with the cover. Made from 5052 grade .090 aluminum.

JAZ-120-300-03 \$ 139.97

Black Vinyl Seat Cover

JAZ-150-301-01 \$ 72.97



Universal Seat Mounts

Bracket kit fits all JAZ seats. Pre-drilled for nine separate seat heights and angle adjustments.

JAZ-450-010-09 ... \$ 29.95



Sliding Seat Mount

Easy to operate single lever. Heavy cadmium plated steel prevents rusting. Can be used on all JAZ seats featuring a flat bottom.

JAZ-450-011-03 ... \$ 38.95



What makes JAZ Poly Seats and Fuel Cells unique?

JAZ polyethylene seats and fuel cells feature hollow, one piece seamless construction with molded-in colors that won't fade, peel or scratch off. These seats and cells each have excellent high and low temperature impact. They will not corrode or rust.

They can be frozen, hit with a hammer and will not break. The double-walled construction of the seats deliver a comfortable, impact absorbing ride. The crosslinking process provides maximum strength and minimum weight with sufficient elasticity to resist shock and vibration damage.

Each seat has molded-in threaded inserts which will withstand a pull-out force of 1600lbs each. Installation is fast and trouble-free.

Roll Bar Padding

SFI 45.1



Colors
Black
Red
Blue

Roll bar padding is made from high-density foam with double-sided tape for secure, non-slip, easy installation. Padding fits 1-1/2" to 1-3/4" diameter tubing. Available in 1/2" & 3/4" thickness.

Sold in 3 foot lengths

\$22.95

Also Available for Helmet Bars (1 - 1.25")



Foam Padding 3' Length

\$7.95

Black, Silver, Red, Orange, Yellow, Blue

Sealed Battery Box

Fits Standard Group 24 battery.
NHRA & IHRA Approved.
Measures 10.5 x 13 x 9.5" tall
Completely sealed lid.
Vent tube to carry battery gases
outside of vehicle.
Rotational molded plastic case is
resistant to battery acid.



JAZ-700-500-01

\$ 77



Mounting brackets and all hardware included!

Stainless Steel Battery Mount



**NHRA &
IHRA
Legal**

Lightweight
Polished SS
*Mounting
Hardware
Included*

RPC-S9323 Universal Mount \$ 29
RPC-S5323 Optima Yellow Top \$ 88
RPC-S6324 Optima Blue Top \$ 98
RPC-S6325 Optima Red Top \$ 98

Torke-Totes



Torke-Totes are designed to house an
8 to 11" torque converter in a dry and
clean environment. Torke-Totes can
also be used as shipping containers.

JAZ-700-100-07

\$ 52

Krank Kase

Prevents journal damage.
Great for transporting/storing
those expensive crankshafts.
Strong enough for shipping.



JAZ-700-300-07 SBC
JAZ-700-301-11 BBC

\$ 67

Cell Mounting Kits

PreFab Steel Brackets designed
to perfectly fit JAZ fuel cells.



JAZ-400-008-03 8 gal cell \$ 36
JAZ-400-012-03 12 gal cell \$ 37
JAZ-400-016-03 16 gal cell \$ 39
JAZ-400-022-03 22 gal cell \$ 42

All JAZ Sizes Available



Head Kase

JAZ storage cases are designed to house a complete
cylinder head with studs and springs in a
clean and safe environment. Great for shipping.

JAZ-700-200-07 SBC .. \$ 74.95ea

20 JAZ-700-201-11 BBC .. \$ 81.95ea



Third Member Storage Case



Keeps third member free of dirt. Fits all Ford 9" and
are stackable. Built-in handles makes for easy handling.
Great for shipping and storage.

JAZ-700-009-01 Horizontal ... \$ 51.95

JAZ-700-010-01 Vertical \$ 54.95



Breather Tanks

This remote 1qt breather/ oil separator easily mounts to a rollbar or firewall. Comes standard with molded-in inserts and a swivel petcock for easy draining.

- JAZ-605-025 AN6 **\$ 45.95**
- JAZ-605-825 AN8 **\$ 47.95**
- JAZ-605-125 AN10 **\$ 52.95**
- JAZ-605-225 AN12 **\$ 61.95**
- JAZ-605-000 Blank **\$ 34.95**



Mini Breathers

\$ 62

Jr Dragsters, Go Carts & small CID Engines

Similar to above breathers but is 1 pint and has two 3/8 or 1/4 hose barbs.

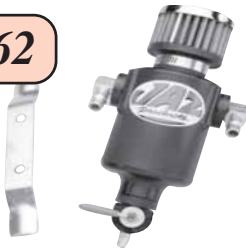

JAZ-605-375

Radiator Overflow Catch-Cans



One-piece molded construction with unique swivel elbow input. Lever handle petcock for easy draining. Meets NHRA requirements for 1qt. capacity. Easy mounting with molded-in threaded inserts.

JAZ-600-025

\$ 21

Colors: Black, Red, Blue, Purple, Orange, Clear



Stainless Steel Overflow

New !

High Luster SS
2pt Capacity
w/ Mounting Bracket

- RPC-S6075X 2x19"
- RPC-S6076X 3x10"

\$ 39

Fuel Cell Tip Over Valve

\$22

Fuel Cell Vent
Prevent Fuel Spill If
Tipped Upside Down

- JAZ-834-006 AN6
- JAZ-834-008 AN8



Small Fuel Cells

Cells are designed for applications utilizing gas & alcohol fuel. The 1 gallon features an aircraft style cap, 1/4" petcock fitting for fuel pickup and vent.



- JAZ-230-025-01 1 Quart **\$ 46.97**
- JAZ-230-051-01 2 Quart **\$ 59.97**
- JAZ-230-001-01 1 Gallon **\$ 120.97**

Funnels & Filters



JAZ funnels feature anti-splash lips. Can be cut to desired length & flow rate. 11 & 14" accepts 60 micron Stainless Steel filter.



- JAZ-555-008-06 8" Round **\$ 15.95**
- JAZ-555-011-06 11" Round **\$ 23.95**
- JAZ-550-014-06 14" Triangular **\$ 15.95**
- JAZ-500-000-01 Filter 60 micron **\$ 21.95**

Radiator Hose Kits

This kit contains 48" of braided stainless steel radiator hose with 4 chrome alum end caps, clamps, hose sleeve adapters and rubber reducers. For upper & lower hoses.



RPC-S7311 Radiator Hose Kit **\$ 89.95**

Braided Stainless Steel Kit
Covers upper radiator hose, heater, fuel & vacuum hoses. Includes chromed alum ends.



RPC-S6678 **\$25**



Rings & Bearings

Same Day Shipping!

800/576-7661

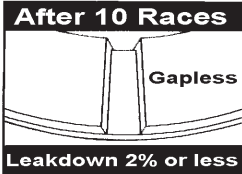
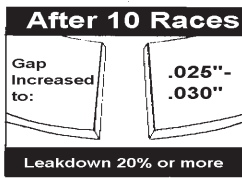
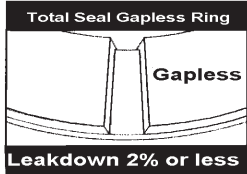
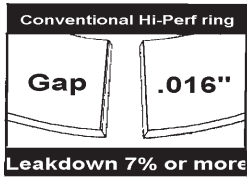

Gapless Piston Rings

As a normal ring wears, the gap opens up allowing more combustion gasses to escape. The Total Seal Gapless ring has no gap. Instead, its patented design incorporates a 2-part interlocking ring to close the gap and provide a more perfect seal between the piston and cylinder.



Keeps Leakdown to 2% or Less!

Leakdown Tester

\$105

Dual Gauge
w/ 14mm Hose
Professional Grade
TS-14MMLDT

Ring Compressor

Heat Treated
Anodized Alum

\$39

Ring Filer

Files piston rings simply and accurately.

Bench mounted

\$93

Gapless 2nd RACE Sets (1/16 1/16 3/16)

4.035 TS-T3690.35	\$ 228	4.355 TS-T6490.35	\$ 232
4.065 TS-T3690.65	\$ 228	4.385 TS-T6490.65	\$ 232
4.155 TS-T0690.30	\$ 228	4.445 TS-T9190.195	\$ 232
4.255 TS-T9190.05	\$ 232	4.505 TS-T9190.255	\$ 232
4.285 TS-T9190.35	\$ 232	4.567 TS-T9130.5	\$ 256
4.315 TS-T9190.65	\$ 232	4.605 TS-T9150.5	\$ 256

Most Popular Sizes Including *Dykes* are in Stock



King Premium Engine Bearings



**R
O
D**

X-R-848HPSTD	SBC w/o Dowel	54.98
X-CR-848HPSTD-X	SBC .001 Oversize w/o Dowel	54.98
X-CR-850HP010	305 SBC .010 w/ Dowel	57.98
X-CR-850HPSTD	305 SBC STD w/ Dowel	57.98
X-CR-850HPSTD-X	305 SBC .001 Oversize w/ Dowel	57.98
X-CR-850HP020	305 SBC .020 w/ Dowel	57.98
X-CR-851HP020	327 SBC .020 w/o Dowel	53.98
X-CR-853HP001	BBC .001 w/ Dowel	69.98
X-CR-853HP010	BBC .010 w/ Dowel	69.98
X-CR-853HP020	BBC .020 w/ Dowel	69.98
X-CR-853HPSTD	BBC STD w/ Dowel	69.98
X-CR-853HPSTD-X	BBC .001 Oversize w/ Dowel	69.98
X-CR-849HP010	BBC .010 w/o Dowel	67.98
X-CR-849HPSTD	BBC STD w/o Dowel	67.98
X-CR-840HP	426 HEMI w/ Dowel	79.99
X-CR-863HP	426 HEMI Upper Only	79.99

**M
A
I
N**

X-MB-5142HPSTD	SBC	54.99
X-MB-5142HPSTD-X	SBC .001 Oversize	54.99
X-MB-5142HP020	SBC .020	54.99
X-MB-5147HPSTD	BBC STD 3/4 Groove	68.99
X-MB-5147HPSTD-X	BBC .001 Oversize 3/4 Groove	68.99
X-MB-5147HP-001	BBC .001 3/4 Groove	68.99
X-MB-5147HP-010	BBC .010 3/4 Groove	68.99
X-MB-5147HP-020	BBC .020 3/4 Groove	68.99
X-MB-5164HPSTD	BBC STD Full Groove	68.99
X-MB-5164HP010	BBC .010 Full Groove	68.99
X-MB-5116HP	426 HEMI	79.99

Proven effective on circle track engines running at 8000rpm, on Top Fuel Blown Engines producing 5500HP as well as on high performance street vehicles. Alecular material offers an extremely high temperature threshold and high load capacity.



Blower Restraints



Billet 7075-T6 Aluminum
Silver Aluminized Straps
Quick Disconnect Pins

Re-certifiable

- DJ-141000 Restraint w/ Hardware SFI 14.1 **\$ 319**
 - Restraint Only, No Hardware SFI 14.1 **\$ 249**
 - DJ-141999 Re-Certification SFI 14.1 **\$ 65**
 - DJ-141002 Adjustable Silver Straps (4ea) .. **\$ 119**
 - DJ-141900 Mounting Hardware w/ pins **\$ 125**
 - DJ-142007 Top Alcohol Restraint with Kevlar Ballistic Bag and Steel Hardware SFI 14.2 **\$ 989**
 - DJ-143101 Top Fuel Restraint with Kevlar Ballistic Bag and Steel Hardware SFI 14.3 **\$1495**
- (Need Premium Gaskets? See Page 36)*

Window & Wheelie Bar Nets

- DJ-221721 Angular 17x21 **\$ 44**
 - DJ-221824 Square 18x24 **\$ 29**
 - JAZ-906-03 Installation kit **\$ 57**
- Wheelie Bar - **CALL**



SFI 27.1

Trans Blankets



Multiple layers of Ballistic material to capture exploding shrapnel.

SFI 4.1

Water and Oil Resistant
Re-certifiable

Engine Diapers



SFI 7.2

Snap-in Absorbant Pads.
Q.D. Adjustable Straps
Ballistic Nylon.
Premium Quality.



- DJ-730350 **SBC**
- DJ-730454 **BBC**
- DJ-730426 **Hemi**

\$189!

Reduced

Most Makes Available

Pro Diapers

SFI 7.1

Adjustable quick release buckles attaches to the header flanges.
Reusable Snap-in Absorbant Pads.Can be recertified.



TF/TA Legal

- DJ-711001.bal Soft Ballistic Nylon **\$ 548**
- DJ-711002 Soft Kevlar (shown) ... **\$ 749**
- DJ-710002 Carbon Fiber Bucket ... **\$ 889**
- DJ-710401 Replacement Pads (pr) **\$ 59**

Plug Wire Shield

Protect spark plug wires in the event of a burst panel or blower back-fire.



DJ-070200 ... **\$ 19.95**

- DJ-801012 Powerglide **\$ 139**
 - DJ-801014 Turbo 350/400 **\$ 179**
 - DJ-801126 Lenco Reverser (only) **\$ 129**
 - DJ-801124 Lenco 2spd w/Rev **\$ 149**
 - DJ-801152 Lenco 3spd w/Rev **\$ 198**
- Over 2 Dozen Models Available !*

Heavy Duty Race Car Tiedowns

Webbing is 2" wide. Burst Strength: 5,000lbs
12' Standard Length. Snap-in J-Hooks Ends

- A. DJ-236201.12 Inline Ratchet Tiedown .. **\$ 27.95**
- B. DJ-236205.8 w/ Sewn-In Axle Loop **\$ 29.95**
- C. DJ-238044 Flush Mounted D-Ring **\$ 9.99**
- D. DJ-237224 Heavy Duty Axle Strap 24" **\$ 10.95**
- E. D-36605 Cycle Tiedown w/ S-Hook **\$ 8.50**
- D-36604 1" x 6' Mini Ratchet **\$ 15.95**
- DJ-241202 Heavy Duty Tow Strap 14' **\$ 26.99**

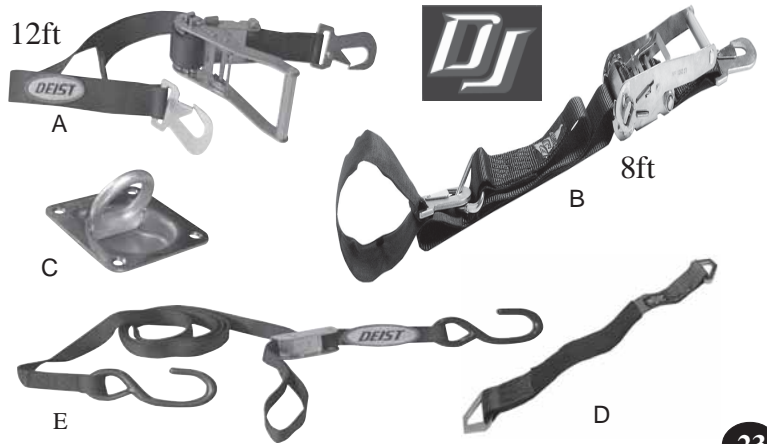

Seat Belts and Harnesses

DJ Safety offers over 100 combinations of 5pt Seat Harnesses.
Options include: Latch/ Link design or Quick Release (CamLock), 2" or 3" wide. **3 Styles of Attachment:** Wrap-around, Bolt-in or Snap-in.



SFI 16.1

\$ 89

\$159

Colors:
Black, Red & Blue
Fresh Dates!

Also Available
in 6 & 7pt.

Seat Belts Out-of-Date?

5pt Latch/Link style ... <i>most</i>	\$ 89
w/ Fire Protective Covering	\$ 149
5pt Cam Lock style	\$ 159
w/ Fire Protective Covering	\$ 198
Rewebb & Recert <i>most</i>	\$ 69
w/ Fire Protective Covering	\$ 109



Cam Lock



Latch/Link

Buckle Styles

Belt Mounting Options

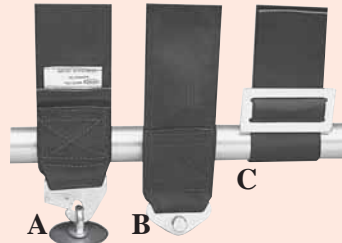

A

B

C

- A. Snap-In
- B. Bolt-In
- C. Wrap Around

All Steel,
No Plastic

Buggy Belts

Bolt-in lap belt with adjustable shoulders. Will work with most street vehicles and dune buggies & sand rails.

Includes Mounting Hardware

Colors: Black, Red, Blue.

DJ-520000..... \$ 46

Shoulder Pads

Shoulder pads are available as Slip-Ons or Sewn-In. Great Driver Comfort.

D-70200 2" Slip-On pads \$ 19

DJ-603050 3" Fire Retardant Pads \$ 35

Sold in Pairs



Premium Seatbelt Hardware

Hardware is made of high quality steel for that measure of safety you are looking for and deserve.



A. DJ-600105 Snap-In Kit w/ Hardware \$ 6.95

B. DJ-600305 Floor Mount Kit w/Hrdwr (pr) \$ 6.95

C. DJ-600402 3-Bar Adjuster 2" (pr) \$ 3.95

C. DJ-600403 3-Bar Adjuster 3" (pr) \$ 5.95

Arm Restraints

Arm Restraints have velcro closure and are adjustable in length.



SFI 3.3

DJ-605000 Arm Restraints \$ 29/pr

Too Fast? We Can Stop You!

Drag Chutes

- DJ-851252 Super Quad (s/g, s/c) \$ 219
- D-24464 Blown Alky & Pro Mod (225mph) \$ 395
- DJ-851424 Blown Gas or Alcohol Boat \$ 395
- DJ-851070 Pro Mod & Top Alcohol \$ 395
- DJ-851079 Top Fuel Dragster/ FC \$ 475
- D-30470 Nylon Pack 7x7 \$ 68
- DJ-852999 Nylon Pack 9x9 \$ 69
- DJ-852996 Silver Pack 9x9 \$ 98
- DJ-852809 Pilot Chute 7" Heavy Duty \$ 69
- DJ-852200 Release Cable with Lever \$ 39

Chutes Include: Quad Cross-Form Canopy, Pack, Pilot and Bridle Line.



Colors:
Black * Red * Blue

Over a Dozen styles to choose from !!

Coldfire 302 Fire Systems

Coldfire302 is a harmless plant & water based fire suppressing agent. Is especially effective in Class B fires (Oil/fuel). Also suitable for wood & paper fires. Suppresses quickly, prevents reflash, safe to store and leaves virtually no residue. Biodegradable and environmentally safe.



- #### Systems
- DJ-911050 5lb \$ 369
 - DJ-911100 10lb \$ 399
 - DJ-911100. 20lb *In Stock*

Accepted by Most Sanctioning Bodies

Fire System is DOT & SFI Approved.
Bottles can also be Refilled.

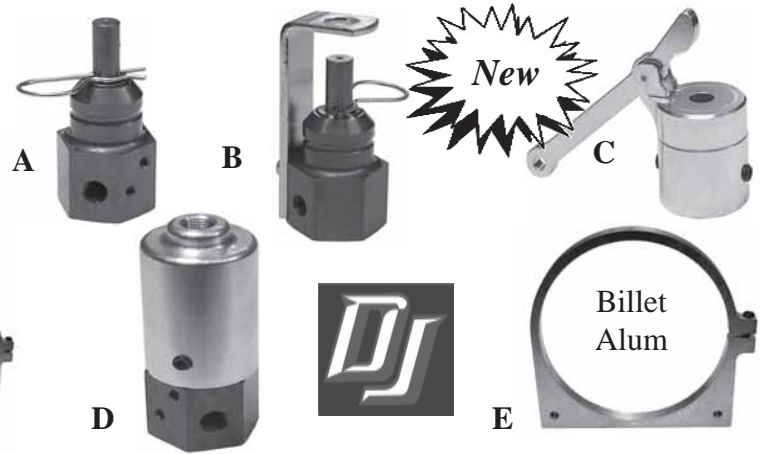

- DJ-911101 10lb Bottle Only \$ 299
- A. DJ-911327 Manual Injector \$ 79
- B. DJ-911328 Mnl Injector & Bracket \$ 85
- C. DJ-911329-2 Pull-Style Adapter \$ 54
- D. DJ-911329 Pneumatic Injector \$ 149
- E. DJ-910410 Mounting Bracket 5.25 \$ 32
- D-89260.438 Mounting Bracket 4.38 \$ 29
- D-91345 Nozzle & Fitting Kit 5pc ... \$ 139
- DJ-911311 Nozzle & Fitting Kit 3pc \$ 79
- Alum Tubing 1/4" (10ft Coil) \$ 14
- DJ-911203 Remote Cable *From* 3ft \$ 49

Nomex Driving Suits

Driving Suits are manufactured to meet one of the following specs:
SFI 3.2A/1, 5 or 20.
 Standard Suits are one solid color with contrasting trim.

Sizes: S-XXL
Colors: Black, Red, Blue

DJ Safety sfi /20 suits can be recertified every 5 years!

Options:
 Arm Restraints
 Kool Pad Pockets
 Embroidery



Choose from 1pc or Separate Jacket and Pants

SFI 1 Suits (1 Layer)	
DJ-011200 Jacket ..	\$ 79
DJ-011300 Pants	\$ 69
DJ-011100 1pc Suit .	\$ 129
SFI 5 Suits (2 Layer)	
DJ-012200 Jacket ...	\$ 169
DJ-012300 Pants	\$ 169
DJ-012500 1pc Suit	\$ 299
SFI 20 Suits (4 Layer)	
DJ-014200 Jacket ...	\$ 629
DJ-014300 Pants	\$ 495
DJ-014200 2 Piece	\$1124
Sewn-in Restraints	\$ 59

Driving Boots



DJ styling Driving Shoes feature padded Kevlar lining and velcro closure.



Sizes: 1-13 in Full Sizes
Colors: Black, Red, Blue, Gray

- DJ-050000 sfi 3.3/5 Shoes \$ 79
- DJ-051000 Alky/TF sfi 3.3/20 Boots \$ 229

Kool Vest

Keeps driver or crew member comfortable for upwards of an hour. Thin vest easily fits under driver's suit. Has one pad on upper back and one on each kidney.

Sizes: S-XXL



D-03520 ... \$ 79

D-03520-3 Extra/Replacement Kool Pads \$8.95ea

Driving Gloves

Leather Palm Gloves offer excellent protection while maintaining a high level of comfort.

- D-04100.331 Nomex sfi 3.3/1 \$ 65
- DJ-022000 Nomex sfi 3.3/5 \$ 59
- DJ-024000 Nomex sfi 3.3/15 \$ 139
- D-84600 Nomex sfi 3.3/20 \$ 139



How to Measure Glove Size:

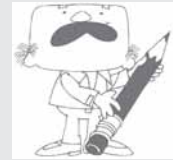

Lay hand flat with fingers and thumb together. Measure circumference at widest point.

- 8" = Sml
- 9" = Med
- 10" = Lrg
- 11" = XL

Colors: Black, Red, Blue



Race Helmets



DJ Helmets are built to meet and exceed Snell SA05 or M05 specs. The "SA" rating has a Fire-Resistant liner.

Full Face

Sizes: XS-XXL

SA2005 \$ 249

M2005 \$ 229



Open Face

Sizes: XS-XXL

SA2005 \$ 229

M2005 \$ 149



Note: Blown Alcohol & Nitro applications usually requires a Snell "SA" rating

Helmet Supports

Velcro Closure
SFI Approved

D-80215 Tapered \$ 59

DJ-040009 Full \$ 29



How to Measure Helmet Size

Hat Size Circumference

XS 6 1/2".... 21 5/8"

S 7"..... 22"

S 7 1/8".... 22 3/8"

M 7 1/4" 22 3/4"

M 7 3/8" 23 1/8"

L 7 1/2" 23 1/2"

XL 7 5/8" ... 24"

XXL 8" 25"

To properly determine head circumference, run a soft tape measure around your head (approximately one inch above your eyebrows and just over the ears).

Equipment Bags



Made from a High Quality rip-stop Nylon. Internal padding. 3 Pockets

Helmet Bag

DJ-036010 \$29.95

Gear Bag

DJ-070410 \$49.95



FOGCITY ProShield
..... \$ 19.95

Available for most Simpson, Bell and other popular helmets



The Fog Shield is a thin transparent film that affixes to the inside of most face shields and WILL NOT FOG. Unlike other anti-fog products, the Fog Shield will not wear out, wipe off or smear. Just install it and forget it. Lasts the life of your face shield.

Head Socks/ Underwear

Head Socks are designed to be worn under the helmet. These soft nomex knit hoods provide an extra measure of protection. Nomex underwear are also soft and gives a driver a few extra critical seconds of time.

D-03211 1 Layer \$ 29

DJ-062002 2 Layer, SFI 3.3 \$ 39

DJ-060000 Top S-XXL \$ 62

DJ-061000 Pants S-XXL ... \$ 62

DJ-063040 Socks \$ 19



Nostalgia Mask

Made of Silver Aluminized
Includes Breathers

D-83110.SIL Mask Non-SFI \$ 349



We stock jr Dragster Safety Equipment !!



Injector Hat Tool Tray

Injector Hat Tool Tray is made from high grade aluminum and black powder coated for an attractive long-lasting finish. The tray has plenty of space for tools & also accommodates 16 spark plugs.

Fits on top of Bug, Bird, Buzzard. **OLS-TT600**

\$129



Rack 'em Up

Piston & Rod

Safely hold and protect a complete set of Pistons & Rods during assembly. A must for the serious racer. **GV-P-1000**

\$154



Head Repair

Here's a great rack to store your Valves, Lash Caps, Shims & Retainers during head repairs. Sturdy billet anodized aluminum bottom tray. **GV-HR-1000**

\$129



Lifter/ Push Rod

Just set this tray in your lifter valley and store your pushrods & lifters in order. **GV-LP-2000**

\$114



Clutch Stand

This rack is heavy-duty yet lightweight, Holds 5 discs and rotors. Designed by a racer for racers. **GV-CL-150-L**

\$109



The Gapper

Billet aluminum.

Quickly, precisely & accurately gap your spark plugs.

\$59



Adjustable AN Wrench

Protect the anodize on your AN Hose Ends. Knurl Thumbscrew. Minimizes chance of over-tightening.

\$49



Fits AN3-20

Mechanix Gloves

Designed to help the professional mechanic with increased grip. Protects from heat & cold. Features CLARINO palm, 3-ply mesh top and elastic Velcro wrist.

Sizes: **XS-XL**

\$19



Feature 100% heat-resistant woven Kevlar fabric, extra long sleeve protects arm above the elbow, oil and fuel resistant, snug fit allows comfortable fit. **MG-05-902**

Heat Sleeves

\$25



Valve Train Trays

These trays are made of a very light-weight yet rigid plastic material with built-in handles. The valve tray holds valve springs, valve locks, and the largest of valves. The rocker tray holds push rods, lifters, poly locks, spark plugs and rocker arms. Perfect for the home mechanic or pro racer.

\$29



JAZ-735-001-06 Valve & Spring Tray

JAZ-735-002-06 Rocker Arm & Lifter Tray

Billet Primer Bottle Top

Machined from Billet Alum and precisely drilled to allow correct flow of fluid during priming of a blown alcohol or nitro engine. Fits most plastic bottles. Used by the Pros.

\$29



Determine Correct Cable

1. Select The Housing Style
2. Measure the Length (Tip to Tip)

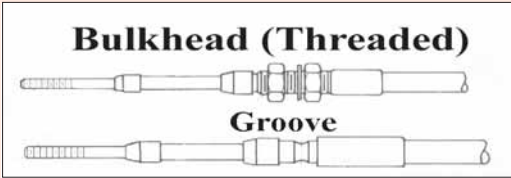

**Custom Length Cables?
No Problem!**

24" Throttle Cable



CC-UV-100-24 Nylon Housing **\$29**

CC-UV-200-24 Stainless Steel **\$39**

*** Cables can be shortened ***



**18'
Chute
Cable**

Stainless Steel **CC-PCTG-216 .. \$31**
Center Wire **With Lever .. \$40**

The Choice of the Pros in Top Fuel & Alcohol



- *Threaded 10-32 Both Ends
- *Grooved or Bulkhead Housing
- *Stainless Steel Inner
- *Heavy Duty Quality



Grooved Housing on Both Ends.

* **Throttle**



Double-Nut **Bulkhead Housing** on One or Both Ends.

* **Shifter**



Grooved Housing on One End.

T-Handle with Double-Nut **Bulkhead** on Driver's End.

* **Fire System, Fuel Shutoff**

Length	Groove	Bulkhead	T-Handle
2 Foot (24")	\$ 36.99	\$ 46.99	\$ 57.99
3 Foot (36")	\$ 36.99	\$ 46.99	\$ 57.99
4 Foot (48")	\$ 38.99	\$ 48.99	\$ 59.99
5 Foot (60")	\$ 40.99	\$ 50.99	\$ 61.99
6 Foot (72")	\$ 43.99	\$ 52.99	\$ 63.99
7 Foot (84")	\$ 45.99	\$ 54.99	\$ 66.99
8 Foot (96")	\$ 47.99	\$ 57.99	\$ 68.99
9 Foot (108")	\$ 49.99	\$ 59.99	\$ 70.99
10 Foot (120")	\$ 51.99	\$ 61.99	\$ 72.99
11 Foot (132")	\$ 54.99	\$ 63.99	\$ 74.99
12 Foot (144")	\$ 56.99	\$ 65.99	\$ 77.99
13 Foot (156")	\$ 58.99	\$ 67.99	\$ 79.99
14 Foot (168")	\$ 60.99	\$ 69.99	\$ 81.99

Cable Brackets

Billet Aluminum & Lightweight

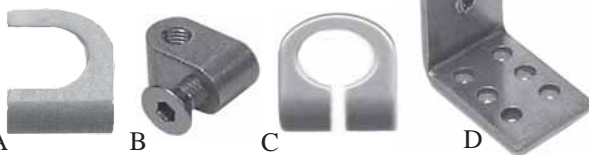

- A. **CC-161-011-V** Billet Half Clamp
- A. **CC-161-011-P** Billet Chute Clamp **\$7**
- B. **CC-091-SP3-A** Chute Pivot
- C. **CC-161-011-VF** Billet Full Clamp
- D. **CC-161-011-M** Swing Hook-Clip **\$9**

Cable Ends

\$8ea

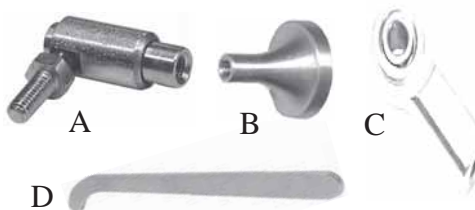

- A. **CC-175-403-0030** Q.D. Ball Joint
- B. **CC-165-172-307A** Round Knob
- C. **CC-CREF-3-3** Female Heime
- D. **CC-PCH-100** Alum Lever **\$9**

Injector Throttle Cable Bracket

\$35



Anodized alum bracket mounts to the front of the blower. Allows quick disconnect of throttle cable.

SAE-239B Bug/Bird

AN Thread Sizes

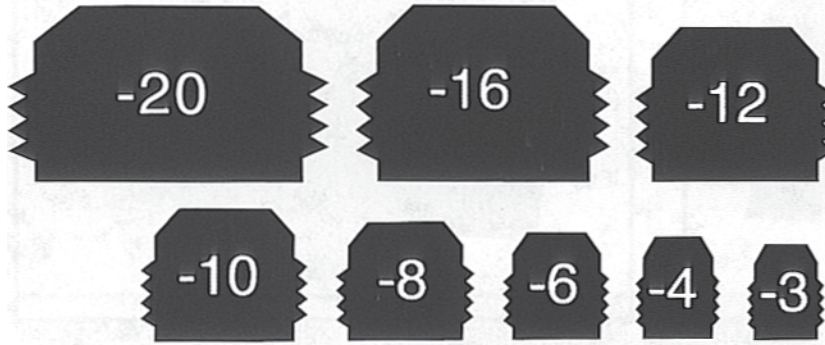

AN Size	Metal Tube O.D.	Thread Size
4	1/4"	7/16-20 UNJ
6	3/8"	9/16-18 UNJ
8	1/2"	3/4-16 UNJ
10	5/8"	7/8-14 UNJ
12	3/4"	1-1/16-12 UNJ
16	1"	1-5/16-12 UNJ
20	1-1/4"	1-5/8-12 UNJ

NPT Thread Sizes

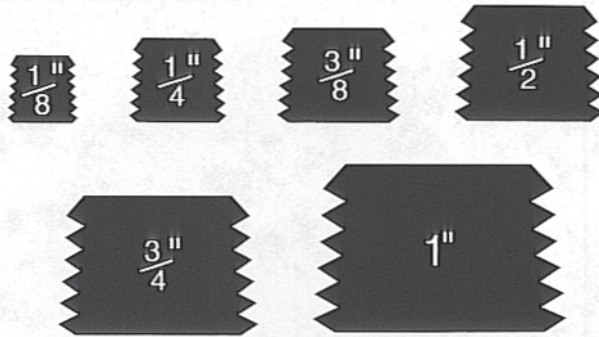

Pipe Thread Size	Threads Per Inch	Fitting I.D.	Closest AN Fitting Size
1/8"	27	1/8"	4
1/4"	18	1/4"	6
3/8"	18	3/8"	8
1/2"	14	1/2"	10
3/4"	14	3/4"	12
1"	11-1/2	1"	16
1-1/4"	11-1/2	1-1/4"	20

Bulkhead Nut Sizes

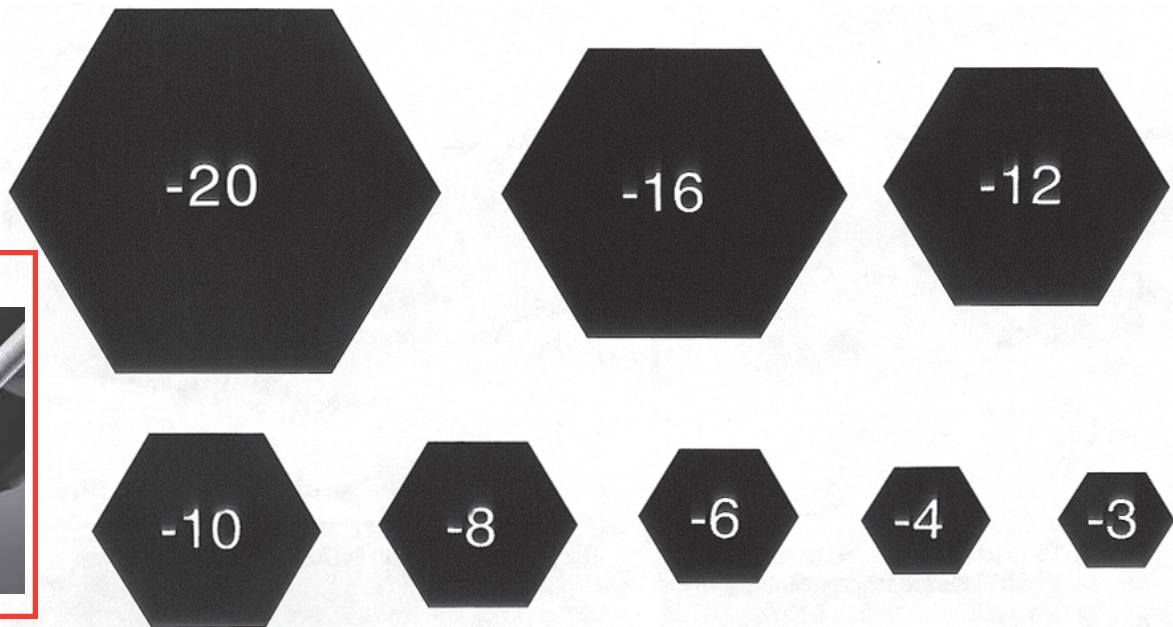

Plumbing Catalog

80 pages of plumbing technical data and photos.



FREE with Purchase!

Aluminum AN Weld Bungs

Female

AN6	X-987106	\$ 9.57
AN8	X-987108	\$ 10.15
AN10	X-987110	\$ 11.99
AN12	X-987112	\$ 12.37
AN16	X-987116	\$ 19.99

Male

X-997106	\$ 3.76
X-997108	\$ 4.99
X-997110	\$ 5.86
X-997112	\$ 9.96
X-997116	\$ 12.90

Alum Female Pipe Weld Bungs

Nut

3/8"	X-996703	\$ 4.99
1/2"	X-996704	\$ 5.88
3/4"	X-996706	\$ 8.40
1"	X-996708	\$ 9.96

Round

X-996803	\$ 3.55
X-996804	\$ 3.89
X-996806	\$ 4.06
X-996808	\$ 4.64

Hose Fitting Assembly

1. Wrap hose tightly with tape at cutting point. Using a fine tooth hacksaw, cable cutters or radiac wheel, cut the hose in the middle of the tape. Remove tape after cutting being careful not to fray the braid.

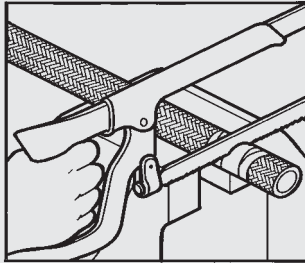

2. Slip hose into socket to the depth indicated by the hose insertion mark on the outside of the socket. This should be just short of the back of the threads. **VERY IMPORTANT** - Mark hose with tape or suitable marking device at rear of socket. This mark will later indicate to you if the hose has pushed out of the socket during assembly.

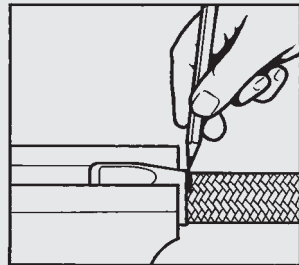

3. Using an anti-seize lubricant, liberally lubricate inside of hose and threads on the nipple. Holding nipple horizontally in a vise equipped with soft aluminum jaws, push socket end carefully with hose nipple with a turning motion and engage nipple threads into those of the socket. Continue tightening by hand as far as possible to make sure that the threads are properly mated and no cross threading has occurred.

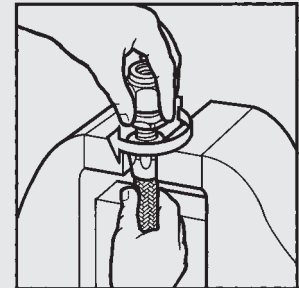

4. Using an aluminum fitting wrench, finish tightening assembly. When properly assembled a small gap of .030" or less should exist between the socket and shoulder of nipple. **NOTE:** Check marks on hose in step 2 for any evidence of push out. Hose assembly must be cleaned and tested to twice the operating pressure.

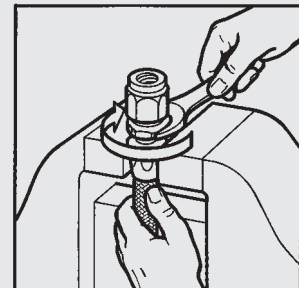

No more Bloody Fingers!

Assemble Braided Stainless Steel hose without poking your fingers. Ideal for racers and performance enthusiasts who have experienced the painful challenge of installing the AN socket.



Award Winner
SEMA Show

KT-468 3pc Kit AN4-6-8 \$ 74

KT-681 3pc Kit AN6-8-10 .. \$ 79

KT-1016 3pc Kit AN10-12-16 \$ 89

KT-416 6pc Kit AN4-16 \$149



\$36

Teflon Hose Separating Tool

Easiest way to assemble braided stainless steel AN3 & AN4 Teflon Hose. **X-821060**

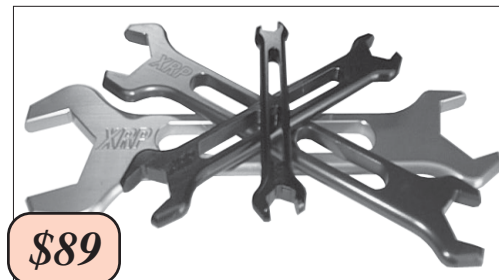

\$89



Professional Aluminum Wrenches

Precisely sized for a perfect fit on AN fittings. Anodized in colors, XRP wrenches are fully radiused to fit your hand. Machined from heat treated 2024 aluminum alloy. **X-750000 AN3-20**

Aluminum Vice Jaws

Vice Jaw inserts protect your hose ends during assembly. Each jaw has magnetic backing to prevent them from falling out of the vice when opened.



X-821010

\$19

Toll-Free Tech Advice &
Online "How-To-Videos"
800/576-7661
DragParts.com



Why Use CPE Braided SS Hose ??



Used by Top Teams everywhere, Stainless Steel braid provides durability and Heat Resistance. Inner liner is composed of Chlorinated Polyethylene (CPE) which provides the finest fluid transfer available with a temperature range of -40 degrees to +300 degrees F.

AN-4	\$ 6.35/ft
AN-6	\$ 6.90/ft
AN-8	\$ 7.90/ft
AN-10	\$ 8.90/ft
AN-12	\$10.90/ft
AN-16	\$11.90/ft
AN-20	\$16.90/ft



Fixed

AN-4	100004..	\$ 7.16
AN-6	100006..	\$ 7.63
AN-8	100008..	\$ 9.61
AN-10	100010..	\$12.57
AN-12	100012..	\$17.19
AN-16	100016..	\$26.43
AN-20	100020..	\$41.70

Straight

Blue & Red Fittings.

* Also Available In *

Black & Super Nickel

Swivel Ends allow one to position hose end after it has been installed on hose.



Fixed

AN-4	104504....	\$ 17.10
AN-6	104506....	\$ 18.46
AN-8	104508....	\$ 21.79
AN-10	104510....	\$ 25.80
AN-12	104512....	\$ 31.13
AN-16	104516....	\$ 39.65
AN-20	104520....	\$ 74.69

45 Degree

Swivel

AN-6	204506....	\$ 20.53
AN-8	204508....	\$ 24.08
AN-10	204510....	\$ 28.04
AN-12	204512....	\$ 33.57
AN-16	204516....	\$ 42.15
AN-20	204520....	\$ Call



Fixed

AN-4	109004....	\$ 17.10
AN-6	109006....	\$ 18.46
AN-8	109008....	\$ 21.79
AN-10	109010....	\$ 25.80
AN-12	109012....	\$ 31.13
AN-16	109016....	\$ 39.65
AN-20	109020....	\$ Call

90 Degree

Swivel

AN-6	209006....	\$ 20.13
AN-8	209008....	\$ 24.75
AN-10	209010....	\$ 28.04
AN-12	209012....	\$ 33.64
AN-16	209016....	\$ 42.15
AN-20	209020....	\$ Call



Fixed

AN-4	118004....	\$ 21.84
AN-6	118006....	\$ 23.35
AN-8	118008....	\$ 26.88
AN-10	118010....	\$ 29.73
AN-12	118012....	\$ 33.72
AN-16	118016....	\$ 44.87

180 Degree

Swivel

AN-6	218006....	\$ 23.08
AN-8	218008....	\$ 27.30
AN-10	218010....	\$ 30.68
AN-12	218012....	\$ 38.06
AN-16	218016....	\$ 55.93



Braided SS TEFLON Hose

Braided Stainless Steel TEFLON Hose and Reusable Hose Ends are used in Brake, Clutch, Instruments and other applications where max high pressure protection is a must.

AN-3	X-610003...	\$ 3.20/ft
AN-4	X-610004...	\$ 3.83/ft

TEFLON Hose Ends



Str
45
90

AN-3	X-600003 ..	\$ 6.25
AN-4	X-600004 ..	\$ 5.85
AN-3	X-604503 ..	\$ 10.95
AN-4	X-604504 ..	\$ 10.95
AN-3	X-609003 ..	\$ 10.95
AN-4	X-609004 ..	\$ 10.95

TEFLON Hose Assembly



We stock Pre-Assembled AN3 & AN4 Braided SS Teflon Hose Assemblies. Straights or 90 Deg Ends.

Lengths: 12" - 48"

from.. \$10

Push-On Hose & Ends

From.. \$3.57/ft

Blue and Black Rubber Hose AN4-12

AN6	X-230006	\$ 4.57
Str AN8	X-230008	\$ 5.44
AN10	X-230010	\$ 7.33
AN12	X-230012	\$ 11.95

AN6	X-239006	\$ 16.29
90 AN8	X-239008	\$ 19.55
AN10	X-239010	\$ 22.40
AN12	X-239012	\$ 26.64



Hose Ends also Available in: 30, 60, 120 & 150 Degree



Tube Nuts



Tube Sleeves

Hose Finishers

Anodized Alum.
Includes SS
Worm Clamp

Red
Blue
Black



<i>Anodized</i>	AN-3	X-981803...	\$.91
<i>Blue Alum.</i>	AN-4	X-981804...	\$.91
<i>Works on Steel or Aluminum Hard Line.</i>	AN-6	X-981806...	\$ 1.19
	AN-8	X-981808...	\$ 1.73
	AN-10	X-981810...	\$ 2.49
	AN-12	X-981812...	\$ 3.36
	AN-16	X-981816...	\$ 5.38

	X-981903...	\$.95
	X-981904...	\$.95
	X-981906...	\$ 1.19
	X-981908...	\$ 1.35
	X-981910...	\$ 2.08
	X-981912...	\$ 3.38
	X-981916...	\$ 3.85

AN4	X-550104	\$ 4.34
AN6	X-550106	\$ 4.34
AN8	X-550108	\$ 4.62
AN10	X-550110	\$ 5.53
AN12	X-550112	\$ 6.49

Hex Pipe Plug

Internal hex for smooth finish and easy installation.



1/8	X-993202 (pr)	\$ 2.43
1/4	X-993203 (pr)	\$ 2.43
3/8	X-993204 (pr)	\$ 3.08
1/2	X-993205	\$ 3.26
3/4	X-993206	\$ 4.20

EPR O-Rings

Long Lasting - Won't Shrink

X-803003	AN3	\$ 3.66
X-803004	AN4	\$ 4.18
X-803006	AN6	\$ 5.01
X-803008	AN8	\$ 5.01
X-803010	AN10	\$ 7.89
X-803012	AN12	\$ 7.89
X-803016	AN16	\$ 4.50*

* packs of five

Ideal for Gas, Alcohol & Nitro



AN Flare Reducers



Female - Male

AN6-4	X-995006	\$ 6.79
AN8-6	X-995008	\$ 7.75
AN10-6	X-995010	\$ 8.68
AN10-8	X-995011	\$ 8.68
AN12-8	X-995012	\$ 10.33
AN12-10	X-995013	\$ 10.33
AN16-12	X-995017	\$ 27.74

Flare Adapters

AN-3	981503	\$ 2.71	AN Flare Coupler
AN-4	981504	\$ 2.71	
AN-6	981506	\$ 2.71	
AN-8	981508	\$ 4.81	
AN-10	981510	\$ 5.60	
AN-12	981512	\$ 10.87	
AN-16	981516	\$ 17.51	



4-3	991902	\$ 4.13	
6-4	991906	\$ 4.24	AN Flare Reducer
8-6	991912	\$ 5.93	
10-6	991914	\$ 8.68	
10-8	991915	\$ 8.42	
12-8	991919	\$ 13.04	
12-10	991920	\$ 13.04	
16-10	991922	\$ 16.95	
16-12	991923	\$ 16.95	
20-12	991925	\$ 23.65	
20-16	991926	\$ 27.95	



Flare to Pipe Adapters

Most other Sizes in Stock



Straight

45 Degree

90 Degree

Flare - Pipe

AN-3.....1/8	981603	\$ 2.28	982303	\$ 7.26	982203	\$ 7.26
AN-4.....1/8	981604	\$ 2.28	982304	\$ 7.39	982204	\$ 7.39
AN-6.....1/4	981606	\$ 2.45	982306	\$ 7.60	982206	\$ 7.60
AN-6.....3/8	981666	\$ 3.17	982366	\$ 10.20	982266	\$ 10.20
AN-8.....1/4	981607	\$ 3.29	982307	\$ 13.04	982207	\$ 13.04
AN-8.....3/8	981608	\$ 3.29	982308	\$ 9.22	982208	\$ 9.22
AN-8.....1/2	981688	\$ 4.81	982388	\$ 14.67	982288	\$ 14.67
AN-10....1/2	981610	\$ 4.88	982310	\$ 14.67	982210	\$ 14.54
AN-10....3/4	981613	\$ 9.12	982313	\$ 21.72	982213	\$ 21.72
AN-12....3/4	981612	\$ 9.12	982312	\$ 21.72	982212	\$ 21.72

Stainless Steel Tubing

Great for plumbing your Brake, Fuel or Fire System.

E-ST18	3/16	
E-ST25	1/4	\$ 5.95/ft
E-ST37	3/8	



Seamless!!

Male Flare to Female Swivel Tee



AN4	X-900304....	\$ 13.67
AN6	X-900306....	\$ 16.92
AN8	X-900308....	\$ 24.73
AN10	X-900310....	\$ 29.94
AN12	X-900312....	\$ 31.24
AN16	X-900316....	\$ 84.12



On Run

On Side

AN ORB Adapters

Male AN Flare to High Contour Inverse Male AN with an O-Ring. Hard Anodized Black.
All Sizes in Stock from:
AN3 - AN20



Swivel AN to Male Pipe

AN3 - AN12
1/8 to 3/4 NPT



Fuel Pressure Take Off Adapters



Tapped 1/8 pipe on the Hex



X-700192	-6 Male to -6 Male	\$ 8.33
X-700194	-6 Male to 3/8" Male NPT	\$ 8.33
X-700195	-6 Male to -6 Female Swivel ...	\$ 9.77
X-700196	-8 Male to -8 Male	\$ 9.73
X-700198	-8 Male to 3/8" Male NPT	\$ 9.73
X-700199	-8 Male to -8 Female Swivel	\$ 11.57
X-700202	-10 Male to -10 Female Swivel	\$ 14.89

Carb Fittings



Dual Feed Holley

X-700106	AN6 to 7/8-20	\$ 7.30
X-700128	AN8 to 7/8-20	\$ 10.94

Single Feed AN6

X-700006	9/16-24 Holley	\$ 5.78
X-700306	5/8-20 Carter	\$ 5.78

Fittings Include Washers

Female Swivel Coupler



AN6	X-900106	\$ 6.63
AN8	X-900108	\$ 8.14
AN10	X-900110	\$ 9.89
AN12	X-900112	\$ 13.86
AN16	X-900116	\$ 19.29



Female Swivel Coupler - 90 Deg

AN4	X-929004 ...	\$ 13.30
AN6	X-929006 ...	\$ 13.30
AN8	X-929008 ...	\$ 14.99
AN10	X-929010 ...	\$ 18.99
AN12	X-929012 ...	\$ 20.48
AN16	X-929016 ...	\$ 47.26

Forged

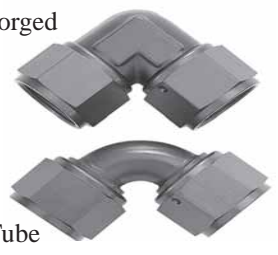

Tube

Liquid Filled Pressure Gauge

Great for *Oil* or *Fuel Pressure*, or *Blower Boost*. Liquid filled for stability and longevity.



X-710000	0-15psi
X-710030	0-30psi
X-710060	0-60psi
X-710100	0-100psi

Shock Resistance

1.50in Diameter

\$39



Gauge Fittings

Connect your Gauges to AN Hoses



X-705003	STRT to 1/8 Fem NPT AN3	\$ 5.27
X-705004	STRT to 1/8 Fem NPT AN4	\$ 2.05
X-705093	90 Deg to 1/8 Fem NPT AN3	\$ 5.16
X-705090	90 Deg to 1/8 Fem NPT AN4	\$ 3.66



Carburetor Line Kit

Gauge Sold Separately

Braided Stainless Steel Multiple Sizes and Styles Available.

As low as .. **\$ 64**





Gear Drives & Covers



Dual Idler High Performance Gear Drive.

(Will not fit OEM roller)

RPC-S8411 SBC
RPC-S8412 BBC

\$109



Alum Timing Cover

Polished Aluminum Cover, Gasket, Seal & Chrome Bolts!

RPC-S6040BOX SBC..... **\$ 47.95**
 RPC-S8422BOX BBC..... **\$ 49.99**
 RPC-S8425 BBC Gen 5.... **\$ 49.99***
 RPC-S8430 BBC Gen 6.... **\$ 49.99***
 * Cover Only

Fixed Single Idler



Polished Alum Cover

\$169

RPC-S8410 SBC



Professional Oil Filters

Spin-On aluminum filter features a re-usable Stainless Steel Element. Very easy to Inspect Oil.



A

Remote Mounts and Block Adapters are machined from billet alum and anodized. Available in AN10 or 12.



A. SYS-209-312361 Oil Filter 4.25" **\$ 141**
 A. SYS-211-510571 Oil Filter 6.37" **\$ 169**
 Replacement SS Element 6.375" **\$ 58**
 B. SYS-221-90004 Remote Mount **\$ 139**
 C. SYS-220-90006 Remote 1.50" **\$ 164**
 D. SYS-228-90556 Block Adapter **\$ 192**



Great for Blown Engines



Billet Cover Chromoly Gears Premier Fasteners

Requires Optional Ext & Shaft

\$959

RCD-251500-0002 BBC

One of the strongest on the market !

We Specialize in Drag Racing Brakes



W-260-4894 Master Cylinder Dual **\$118.98**
 W-260-6764 Master Cylinder 3/4" **\$ 57.98**
 W-260-6765 Master Cylinder 7/8" **\$ 57.98**
 W-260-6766 Master Cylinder 1" **\$ 57.98**
 W-260-1874 Residual Valve 2psi **\$ 17.98**
 W-120-2498 Front Caliper Dynalite **\$ 92.85**
 W-120-6818 Rear Caliper Dynalite **\$124.95**
 W-150-1251K Front Pads Round Spot **\$ 32.98**
 W-150-8937K Front Pads Square **\$ 39.98**
 W-150-8850K Rear Pads **\$ 42.98**
 W-140-3326 FC/Altered Front Brake Kit ... **\$498.98**

FC/Altered Front Brake Kits



Designed for the PS/Anglia style spindle popular on Funny Cars and Altered.

\$ 498.98

Front Brake Kit.

Includes Mounting Hardware!

In-line Residual Valves retain a minimum line pressure (2 psi) to eliminate excessive pedal travel.



Wilwood Master Cylinders are High Pressure die-cast from High-Grade Aluminum, fully machined and assembled with exclusive features.





Accu-Seal Gaskets

Accu-Seal is the first choice of engine builders and race teams. The **Accu-Seal E** gasket line delivers precision fit, durability and economy all in one. **Accu-Seal Pro** utilizes state-of-the-art materials such as *proprietary steel core laminate with teflon coating, viton oil seals, and molded rubber* for selected Oil Pan and Valve Cover applications.

p/n: 1xxxxx = **Economy** 2xxxxx = **Pro**

Intake Gaskets



- SCE-111101 SBC Stock Port \$ 12.95/pr
- SCE-211101 SBC Stock Port Silicone Bead \$ 16.95/pr
- SCE-111102 SBC Large Port \$ 12.95/pr
- SCE-211102 SBC Large Port Silicone Bead \$ 17.95/pr
- SCE-113115 BBC Rectangular, No Top bolt \$ 12.95/pr
- SCE-213101 BBC Oval Port Silicone \$ 19.95/pr
- SCE-213102 BBC Rectangular Silicone ... \$ 19.95/pr
- SCE-1132013 426 Hemi Stock Port 2.375 \$ 8.99/ea
- SCE-1134819 426 Hemi Medium Port 2.750 \$ 8.97/ea

Valve Cover Gaskets

Premium Quality & Re-usable



- SCE-211075 SBC Laminated Silicone \$ 19.95/pr
- SCE-213075 BBC Laminated Silicone \$ 23.95/pr
- SCE-1139011 426 Hemi Heavy Duty \$ 11.47/ea
- SCE-266075 426 Hemi Teflon Coated \$ 34.95/pr

Engine Seals

Front

Rear Viton

- | | | | | |
|----------|-----------|---------|-----------|---------|
| SB Chevy | SCE-11102 | \$ 3.95 | SCE-21105 | \$19.95 |
| BB Chevy | SCE-11302 | \$ 7.95 | SCE-21305 | \$24.95 |
| 351W | SCE-13602 | \$ 7.95 | SCE-23605 | \$14.95 |
| BB Ford | SCE-13502 | \$ 7.95 | SCE-23505 | \$21.95 |
| SB Mopar | SCE-16902 | \$ 7.95 | SCE-16904 | \$ 9.95 |
| BB Mopar | SCE-16402 | \$ 7.95 | SCE-26405 | \$19.95 |
| 417 Hemi | SCE-16702 | \$ 7.95 | SCE-13405 | \$19.95 |
| 426 Hemi | SCE-16602 | \$ 7.95 | SCE-26605 | \$23.95 |

Front Cover



- SCE-11100 SB Chevy
- SCE-11300 BB Chevy
- SCE-13600 SB Ford
- SCE-13500 BB Ford
- SCE-16900 SB Mopar
- SCE-16400 BB Mopar
- SCE-16600 426 Hemi

Inlcudes Water Pump & Fuel Pump Gaskets

\$6.95ea

Blower Gaskets & Seals

Premium Gaskets

- SMI-130170 Snout \$ 3
- SMI-130169 Front Cover \$ 5
- SMI-130163 6.71 Base \$ 9
- SMI-134481 8-10.71 Base .. \$ 9
- SMI-130166 14.71 Base \$ 12
- SMI-130165 Inlet w/ screen \$ 9
- SMI-130164 Inlet w/o screen \$ 7
- BDS-14B6C Carb Gasket \$ 3
- BDS-24B6CD Dom Gasket \$ 3

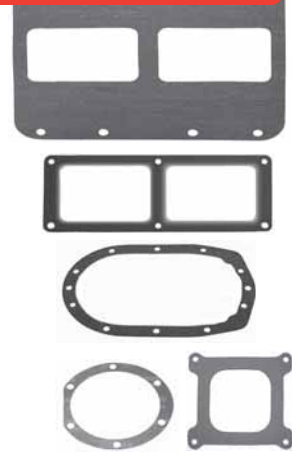

Bearings & Seals

Seals are heavy duty double-lipped teflon and designed for extreme temperature and pressure to maximize efficiency. Bearings are pre-sealed for longer life.

- BDS-671BK Street Bearing/Seal kit \$ 93
- BDS-671HDBK Comp Brng/Seal kit \$ 104
- BDS-671SL1 Standard Seal \$ 8
- BDS-671SL2 Oversize Seal \$ 8
- BDS-671SS Shaft Saver \$ 5
- BDS-500-3 Snout Seal \$ 8



BUNA O-Ring Material (ft)

- SMI-1812000005 1/8 Diameter \$.95/ft
- Also Available in: 3/32 & 3/16 \$.95/ft

Oil Pan (Re-usable)

- SCE-111091 SBC Pre 1974 Thin Front Seal \$ 12.95
- SCE-113090 BBC .090 Thick \$ 12.95
- SCE-235091 BB Ford 1pc Molded \$ 32.95
- SCE-113091 KB Olds .090 Thick \$ 15.95
- SCE-113092 Merlin Block, Lge stroke prov \$ 15.95
- SCE-167091 417 Hemi \$ 14.95
- SCE-134995 426 Hemi, KB, BAE \$ 11.95
- SCE-266091 426 Hemi Steel Core/ Teflon \$ 29.95

Complete Pro Sets

- SCE-211350 SBC 350 \$ 89.95
- SCE-236302 Ford 302 \$ 89.95
- SCE-236305 Ford 351W \$ 109.95
- SCE-235460 Ford 429-460 \$ 109.95
- SCE-128400 Pontiac 389 ... \$ 159.95

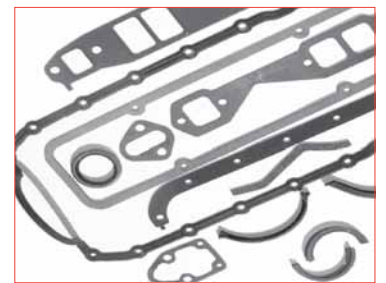

Copper Head Gaskets

Benefits of Using Copper...

Conductivity. Copper is the standard by which all other conductors are measured, therefore a copper gasket provides superior thermal conductivity, acting to stabilize head and block temperatures which makes tuning easier.

25% Coefficient of Elasticity. One of the properties of copper is that it stretches before a catastrophic failure, thereby providing an extra measure of safety in case of severe detonation.

Strength. Copper (in the form SCE use) has a tensile strength of approximately 32,000 psi, compare this to the 1200 to 1800 psi tensile of most facing materials used on conventional performance head gaskets.

**Premium Quality * Properly Annealed
Perfect Fit * Dead Soft Copper**

- .032 \$ 85/pr
- .043 \$ 85
- .050 \$ 89
- .062 \$ 89
- .070 \$ 119
- .080 \$ 119



O-Ring Wire
304 Stainless Steel
SCE-31541 15ft **\$10.95**



Pro-Copper Exhaust Gaskets

SCE Copper Exhaust Gaskets will permanently seal a warped or uneven flange.



In Stock: Chevy, Mopar, Ford **Embossed \$29/pr**
*** Reusable *** **Non-Embossed \$39**



The World's First Self Sealing Copper Head Gasket!

SCE's TITAN gaskets provides unbeatable strength and user friendly installation. This patented headgasket gives you the best of both worlds: The combustion sealing strength of a SCE copper head gasket and the confidence of **built-in coolant and oil seals!** The perfect racing and performance copperhead gasket!



- .032 **\$138**
- .043 **\$138**
- .050 **\$148**
- .062 **\$158**
- .080 **\$168**

Sold in Pairs

ICS Copper Head Gaskets

Same as above but with a **Integrated Steel O-Ring** means there is no need to machine your Block or Heads!



No O-Ring Required!

- .032 **\$188**
- .043 **\$188**
- .050 **\$198**
- .062 **\$228**
- .080 **\$234**

Embedded silicone to seal oil and water passages. Soft copper is ready to use. **Awarded Best New Product at SEMA Show.**

Sold in Pairs



Collector Gaskets

Use SCE copper collector gaskets for maintenance free operation.

2.5, 3 and 3.5in **\$11.95/pr**

Blower Starter

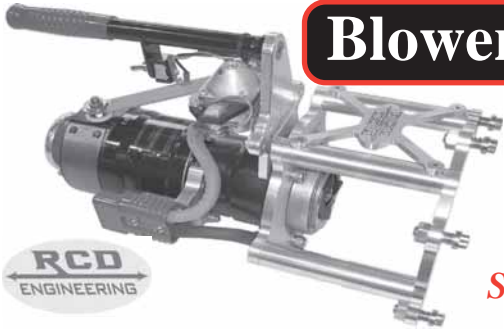

Lightweight &
Removable
36-48-60 Volts

Simply the Best !

- RCD-100500-0011 Blower Starter **\$1598**
- RCD-102505-0065 Battery Cables 15ft **\$ 125**
- RCD-102505-0005 200 Amp HD Relay **\$ 159**
- MMC-7043K82 Q.D. Battery End **\$ 19**

Bearing Supports



Chrome-Moly Crank Hub
Billet Aluminum Plate & Standoffs
Minimize Crank Flex & Bearing Damage

- RCD-202200-0002 Bearing Support SBC **\$ 439**
- RCD-202203-0020 Crank Hub for SBC Support ... **\$ 369**
- RCD-202400-0002 Bearing Support BBC **\$ 469**
- RCD-202403-0020 Crank Hub for BBC Support ... **\$ 369**
- RCD-202600-0004 Bearing Support HEMI **\$ 649**
- RCD-202603-0020 Crank Hub for HEMI Support **\$ 368**
- RCD-201010-0010 Crank Hub Degree Ring **\$ 59**
- RCD-201020-0007 Ring w/ Magnets 6.38" **\$ 119**
- RCD-358875 Premium Crank Bolt Gun-Drilled **\$ 39**

Belt Guards & Components

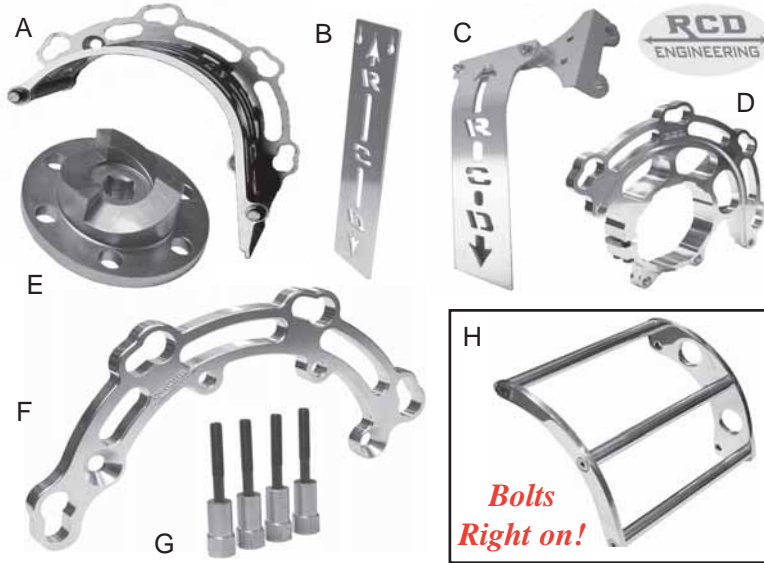

- RCD-103507-0010 Top Belt Guard, SSI 3-Hole **\$ 159**
- RCD-103507-0018 Top Belt Guard, Snout Mntd **\$ 169**
- RCD-157019-15 Snout Mounted Guard Clamp **\$ 129**
(Specify with or w/o Starter Bracket for Belt Guards)
- A. RCD-103507-0004 Top Belt Guard, Roots **\$ 169**
- B. RCD-103512-10 Middle Belt Guard **\$ 45**
- C. RCD-103522-0003 Lower Belt Guard **\$ 135**
- D. RCD-103507-51 Starter Face Plate & Clamp **\$ 229**
- E. GV-STARTERDOG Steel Starter Dog **\$ 65**
- F. RCD-103507-03 Blower Starter Face Plate **\$ 59**
- G. Belt Guard Mounting Kit For RCD Guards .. **\$ 59**
(Mounting Kits Available from 1.75" - 3.00" standoffs)
- H. GV-BELTGUARD Billet Alum Belt Guard **\$ 139**
(Guards 6 to 12" in length. **No Add't** Hardware Required)

Hi TORQUE™ INC. IMI Performance Products

4.40 to 1 Gear Reduction
534 ft./lbs. Torque!
Designed for High Comp Engines
Lightweight (8.8lbs)
Compact and Adjustable
Heat Resistant Solenoid

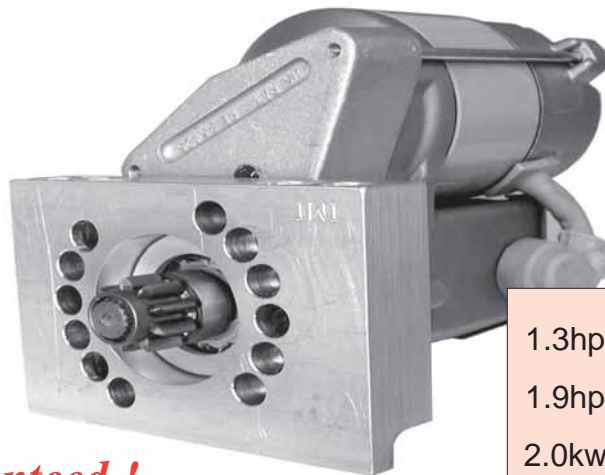

US
Patented

- 1.3hp **\$179**
- 1.9hp **\$219**
- 2.0kw **\$249**

Chevy
Pontiac
Olds
Ford
Marine
Mopar
VW
Porsche
Harley



Zoomie Headers

Weld-Up Kits

.065 Wall Thickness.
FC, Dragster & Altered.

Includes Flanges!

Dragster

(Single Wall)

2.00" SBC **\$375**

2.50" BBC **\$395**

2.50" Hemi **\$450**

FC/ Altered

(Double Wall)

2.50" BBC **\$450**

2.50" Hemi 426 **\$450**

2.25" Hemi 392 **\$475**

2.00" **SBC** FC Single Wall ... **\$475**



Quick-Connect Burndown Tubes

Anodized Aluminum
Positive Locking
Heat Treated Flanges



1.25" Hose
Clear .. **\$5/ft**

NHRA & IHRA Accepted



\$169

HEMI

ALL
OTHERS

PS Anglia-Style Boulton Spindle Kits

304 Stainless Steel with 2" King pin bosses.
Spindles are CNC machined and has double-lock
on steering arm to insure against movement.

Dragsters, Funny Cars and Altered.

Complete:

Pins, 2 Arms,
Caps & Grade
8 Hardware.

\$319

Premium DZUS Fasteners

- A. SPE-8300 Steel .550 Button **\$ 1.55**
- B. SPE-8302 Steel Plate **\$.65**
- C. SPE-8304 Steel Spring **\$.70**
- D. SPE-8307-R Doubler Round **\$.85**
- E. SPE-8307-S Doubler Square **\$.85**

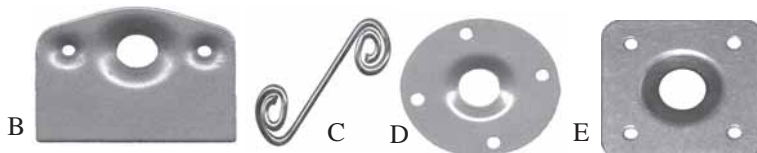

Self Ejecting

- F. SPE-8300.SE5 Assembly **\$ 2.20**
- G. SPE-8302.SE5 Plate **\$.65**
- H. SPE-8304.SE5 Spring .. **\$.70**

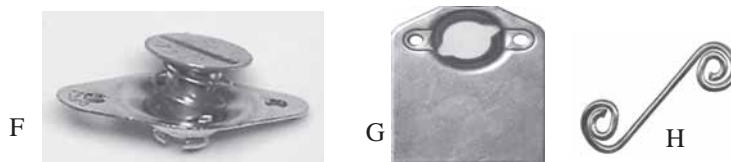

Dimpling Tool

Professional way to
dimple your sheet
metal for DZUS.

\$10



SPE-8300-DT .. **\$18**



DZUS Wrench

Hi-Quality Rod Ends

Male or Female
Left & Right Hand



Female Right Hand

- CREF-3-3 10-32 **\$7.99**
- CREF-4-4 1/4-28 **\$6.99**
- CREF-5-5 5/16-24 **\$7.99**
- CREF-6-6 3/8-24 **\$7.99**
- CREF-7-7 7/16-20 **\$8.99**
- CREF-8-8 1/2-20 **\$9.99**

Male Right Hand

- CREM-3-3 10-32 **\$7.99**
- CREM-4-4 1/4-28 **\$6.99**
- CREM-5-5 5/16-24 **\$7.99**
- CREM-6-6 3/8-24 **\$7.99**
- CREM-7-7 7/16-20 **\$8.99**
- CREM-8-8 1/2-20 **\$9.99**

Female Left Hand

- CREF-3L-3 10-32 **\$7.99**
- CREF-4L-4 1/4-28 **\$6.99**
- CREF-5L-5 5/16-24 **\$7.99**
- CREF-6L-6 3/8-24 **\$7.99**
- CREF-7L-7 7/16-20 **Call**
- CREF-8L-8 1/2-20 **Call**

Male Left Hand

- CREM-3L-3 10-32 **\$7.99**
- CREM-4L-4 1/4-28 **\$6.99**
- CREM-5L-5 5/16-24 **\$7.99**
- CREM-6L-6 3/8-24 **\$7.99**
- CREM-7L-7 7/16-20 **Call**
- CREM-8L-8 1/2-20 **Call**



PRO Plug Wire

Mallory PRO WIRE Plug Wires are designed to withstand the high temperatures that performance engines produce. PRO WIRE Spark Plug Wire provides protection to over 500 degrees F.

SS or Carbon Core

- M-787 Hemi SS Straight Ends \$ 125
- M-783M Chevy SS 90 Deg Ends .. \$ 69
- M-797 Chevy Carbon 90 Deg Ends \$ 49

Red PRO Shield 25' M-836

PRO SHIELD is a insulated sleeve that may be installed on all 7 & 8mm wires for protection against cross-fire and arching. Also helps reduce damage to plug wires from sharp edges. Pro Shield prevents spark plug wire damage from contact with water, oil or fuel.



\$ 87

SUPER-MAG Transformer

COIL is externally mounted making for a more efficient and powerful magneto. HEI style contact terminals resulting in a more positive wire retention.



- M-28900A Pro Oil-Filled Coil \$ 229
- M-28900B Epoxy-Filled Coil \$ 274



Oil Pump Drives

- M-29003 Std ChevyDeck Pump Drive \$ 79
- M-29007 Tall BBC Deck Pump Drive \$ 119

Billet Magneto Bases



- A. M-35595 Chevy Base w/ Bronze Gear \$ 239
- M-35365 Hemi Straight Base \$ 239
- B. RCD-303000-0015 Hemi Angled Base \$ 928
- C. RCD-301811 Hemi Hold-Down Clamp \$ 65
- D. M-45520 Alum Slip Collar Clamp \$ 29
- E. GV-MAGCLAMP Billet Magneto Clamp \$ 98
- F. M-26041A Stainless Steel Magneto Clamp \$ 69
- G. M-29426 Ford-Chevy Bronze Gears \$ 59



Need Spark?

Mallory Super Mag III
3.8 amps

Great for Supercharged Alcohol Engines. Kits include Generator Assembly, Billet Aluminum Base, Coil, and Wiring Harness.

- M-35-36544 LH Hemi Pro Cap
 - M-35-59544 RH Chevy Pro Cap
 - M-35-59514 RH Chevy Stack Cap
- Also Available for Fords & Mopar

\$ 1249

Includes padded shipping case!

Billet Offset Drives

Accepts Mallory or MSD Mags. Includes Bronze Gear. Belt-Driven. Available in Fixed Flange or Adjustable Clamp Styles.



- A. GMSTDF 3.56" Flange \$ 569
- A. GMLNGF 6.56" Flange \$ 669
- B. GMSTDC 3.56" Clamp \$ 599
- B. GMLNGC 6.56" Clamp \$ 699
- C. GMGEAR Star Coupler \$ 49
- D. RCD-302000-0005 Front \$ 898
- E. GS-FDRIVE Front Drive \$ 995
- F. GS-SUPCLAMP MSD \$ 159
- G. DN-OFF.CHEVY \$ 695
- H. DN-OFF.HEMI \$ 795
- I. DN-XDRIVER Coupler \$ 49
- J. RCD-302500-0010 Front \$ 725



New



Magneto Components



- M-28103A** Advance Lock Out \$ **33.99**
- M-28995** Rotor (RH) Stack Cap \$ **41.99**
- M-28995A** Rotor (LH) Stack Cap \$ **41.99**
- M-29038** Rotor Adapter \$ **8.49**
- M-29772** Rotor (RH), Pro Cap \$ **21.99**
- M-29772C** Rotor/Adapter w/ nylon screws \$ **63.99**
- M-29773** Rotor (LH) Pro Cap \$ **23.99**
- M-25758M** Premium Contact Points \$ **24.49**
- M-28005A** .36mf (Small) Condenser \$ **31.49**
- M-28005** .56mf (Large) Condenser \$ **38.49**



- M-28862** Wiring Harness \$ **20.49**
- M-205M** HEI Stack Cap \$ **63.99**
- M-29745** HEI Pro Cap \$ **53.49**
- M-29744** Wire Retainer \$ **28.49**
- M-26007B** 4 Pin Drive Flange \$ **37.99**
- M-26030** Woodruff Key \$ **1.95**
- M-28797** Shrink Sleeving..... \$ **4.99**
- M-28974** Timing Indicator \$ **3.98**

Electronic Distributors

Low profile with flat cap for max clearance
CNC billet housing / Unilite Pointless
Small Diameter Bowl



Curved for Blown Engines

- M-3755801** Ford 351W
- M-3756001** Ford 460
- M-3768501** Chevy V8

\$ 399



Electronic Ford Offset
Billet Alum * Pro Cap * Belt Driven
Ideal for Blown Engines

Ford 302 / Ford 460 **\$ 945**

How to Set a Mag with a Buzz Box



1. Rotate crankshaft until desired amount of ignition timing is lined with timing pointer.
2. Find out where #1 cylinder is in the cap and make a mark on outside of generator case.
3. Find out where last cylinder segment in firing order is in cap and mark on outside of generator case.
4. Line up all intermediate oil pump drives and gear drive so as to place the rotor approximately 1/2 the way between #1 cyl segment and the last segment in the firing order when the ignition is firmly seated on the manifold or block surface.
5. At this time you should check the play between the intermediate shaft and the ignition or the block and the thrust face on the gear. Some play or clearance must be present. If not when you tighten your ignition down you might be jacking your oil pump gear though the bottom plate of your pump.
6. Snug up the bolt/nut on the retainer so you can move the ignition with a slight amount of resistance.
7. Hook up the buzzer to the orange & yellow primary wires and turn it on. The buzzer may be buzzing now or it may not—not to worry at this time.
8. Determine which way the rotor rotates and hold back against it with your thumb, applying a few ounces of pressure.
9. Turn the outside case of the ignition against the rotation until the buzzer just stops. You might have to do this 2-3 times to get the feel of it, but the mag will fire just as the buzzer stops (this is when the point opens).
10. Tighten up the ignition clamp bolt/nut.
11. To check if you're right there in the ball park ignition wise, reach up and grasp the rotor and turn it the way you did before. It should buzz when back pressure is applied to rotor and quit buzzing with reduction of pressure.

Don Zig Mag Buzzer

Necessary To Set Magneto Timing

ZIG-TB100 \$ 119



Kill Switches

Designed specifically for mags.
Positive push-off. Internally sealed to prevent corrosion.



Premium Super Mag Kill Switch
M-26074 \$29



SAE-101



Single Magneto

- SAE-101..... \$ **129**
- M-26072..... \$ **314**

Dual Magneto

- SAE-103..... \$ **175**

Power Building DVD's



Multi-DVD sets are part of a series tailored towards racing and street performance. Filled with money and time saving advice. Great for the novice and veteran.

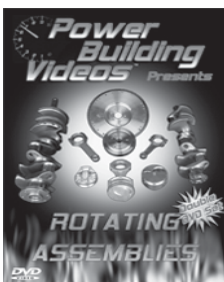

- PWR-D-NITROUS Nitrous**
- PWR-D-SUPR Blowers**
- PWR-D-CARB Carburetors**
- PWR-D-ROT Rotating Assy**

\$29.95

Good Vibrations will refund the price of the Blower DVD with the purchase of a blower!

Legal Stuff... Telephone Orders

Order lines are open between 8am and 4:30pm (PST) Mon-Fri. Also online at: www.DragParts.com. Most orders are processed and shipped within 24 hours. UPS is the method of shipping unless otherwise specified. Domestic UPS Ground is approximately 1-4 business days, depending on your location. Faster service is available (See Pg 2).

Payment Policy

Orders can be prepaid by Mastercard, Visa, Discover credit/debit cards. Cancelled orders can be subject up to a 15% cancellation fee.

Freight & Shipping

All shipments are shipped freight prepaid unless other arrangements are made. All shipments are fully insured. If your shipment is damaged, save all packaging material and contact the freight carrier immediately.

Returns

A copy of the original invoice must accompany all returns within 30 days of the original purchase date. No reasonable return will be refused, however we reserve the right to apply up to a 15% restocking fee.

Shortages or Discrepancies

All shortages or discrepancies must be reported within 10 days from receipt of shipment. Please include invoice number and date of receipt.

Warranty

Most products carry the manufactures warranty. Good Vibrations Motorsports will not be held liable for any loss, damage, injury or casualty arising from the use of products supplied by Good Vibrations. Not for sale or use on pollution controlled vehicles

Prices & Specifications

All prices are subject to state sales taxes where applicable. All prices are subject to change without notice.

Not for sale or use on pollution controlled vehicles

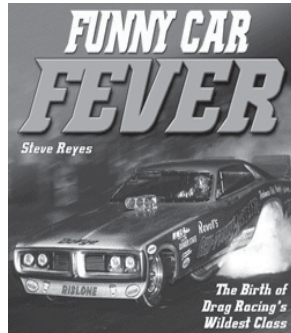
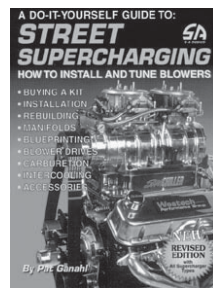
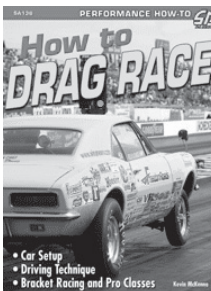
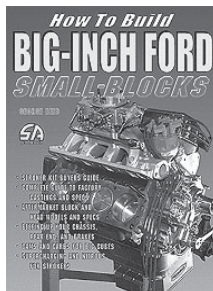
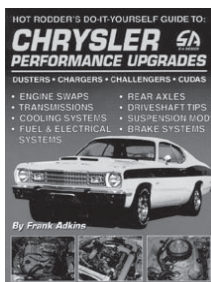

2 Great Books for the Coffee Table, Office or where ever you do your best reading! Rich in History with 100's of Color Pics.

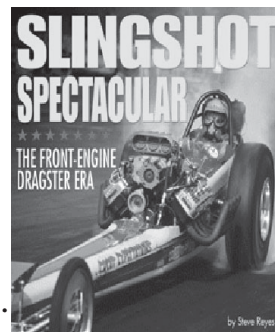

Performance Books

Books are 128 pages. Feature 300 photos!

- SA-60 CHRYSLER PERF UPGRADES
 - SA-78 BUILD PERF PONTIAC
 - SA-85 BUILD BIG INCH SBF
 - SA-87 BUILD BIG INCH SBC
- Above Titles **\$16.95**

SA-17 STREET SUPERCHARGING **\$19.95**



SA-CT443
FC Fever

\$25

SA-CT464
Slingshots

SA-161 ELEC FUEL INJECTION
SA-95 HOW TO DRAG RACE

Limited Edition T-Shirt

\$12

**Good Vibrations (Rear)
Enderle (Front)**

6 Colors

**100 Pre-shrunk
USA Cotton**

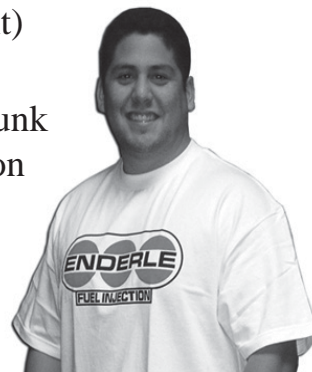

Pg 6

**Bypass Pill
Screwdriver**



Pg 28

Spark Plug Adjuster

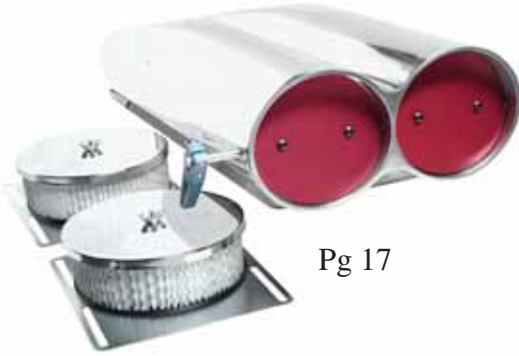

Pg 17

Shotgun Carb Scoop



Pg 7

Injection Primer Kit



Pg 3

Small 4 3/8 Big & Ugly

**Injector
Throttle
Bracket**



Pg 8

**New
Products!!**



Pg 9

HEMI Valve Covers

Pg 39



DZUS Wrench

Pg 42



New T-Shirts !!



Pg 39

Stainless Steel Spindles

Pg 25

**Pull-Style Fire
Bottle Actuator**



Pg 28

Piston Rack



Pg 40

Magneto Front Drive



Pg 40

**MSD Magneto
Support Clamp**

**Instant \$10 off
First Web Order!**

Coupon Code: 8998

Our Mission:

At *DragParts.com*, we strive to provide high quality performance products at discount prices without sacrificing customer service.

GOOD VIBRATIONS

8858 Painter Ave, Suite E
Whittier, CA 90602

PRSR STD
US Postage
PAID
Whittier, CA
Permit #243



Proudly Made
in the USA

Since 1985

New Racing Products
Used Performance Parts
Free Technical Advice
Free Racing Classifieds



We STOCK these
Quality Brands



Online 24/7

GoodVibrationsRacing.com

New & Preowned Performance Products

Toll Free (800) 576-7661